

HIKOKI

充电式多功能工具(万用宝)
Cordless Multi Tool

中文
English

CV 18DA

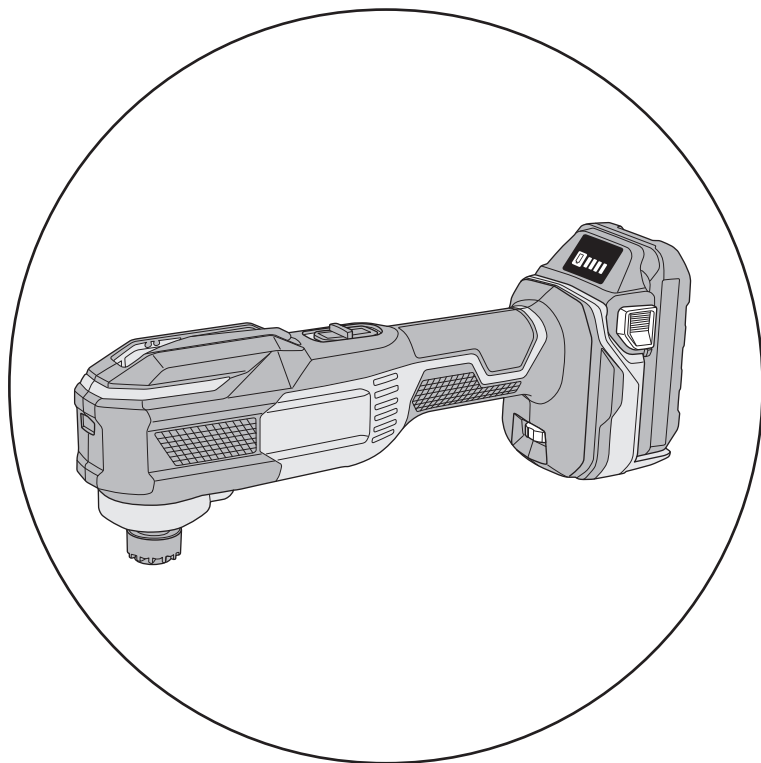

保留备用
Keep for future reference



使用说明书
Handling instructions

目次

电动工具通用安全警告.....	2
充电式多功能切割打磨机安全警告.....	5
其他安全警告.....	5
锂离子电池使用注意事项.....	7
锂离子电池运输.....	9
符号.....	9
零件名称.....	10
规格.....	10
标准附件.....	11
用途.....	11
电池及电池盖的拆卸、安装方法.....	11
充电.....	12
作业之前.....	15
操作.....	17
应用工具的选择.....	21
维护和检查.....	21
选择附件.....	23

电动工具通用安全警告

警告！

阅读电动工具附带的所有安全警告、说明、插图和规格说明。
不遵照以下说明会导致电击、着火和 / 或严重伤害。

保存所有警告和说明书以备查阅。

在所有下列的警告中术语“电动工具”指市电驱动（有线）电动工具或电池驱动（无线）电动工具。

1) 工作场地的安全

- a) 保持工作场地清洁和明亮。
混乱和黑暗的场地会引发事故。
- b) 不要在易爆环境，如有易燃液体、气体或粉尘的环境下操作电动工具。
电动工具产生的火花会点燃粉尘或气体。
- c) 让儿童和旁观者离开后操作电动工具。
注意力不集中会使操作者失去对工具的控制。

2) 电气安全

- a) 电动工具插头必须与插座相配。绝不能以任何方式改装插头。需接地的电动工具不能使用任何转换插头。
未经改装的插头和相配的插座将减少电击危险。
- b) 避免人体接触接地表面，如管道、散热片和冰箱。
如果你身体接地会增加电击危险。
- c) 不得将电动工具暴露在雨中或潮湿环境中。
水进入电动工具将增加电击危险。
- d) 不得滥用电线。绝不能用电线搬运、拉动电动工具或拔出其插头。使电线远离热源、油、锐边或运动部件。
受损或缠绕的软线会增加电击危险。
- e) 当在户外使用电动工具时，使用适合户外使用的外接软线。
适合户外使用的软线将减少电击危险。
- f) 如果在潮湿环境下操作电动工具是不可避免的，应使用剩余电流动作保护器（RCD）。
使用RCD可减小电击危险。

3) 人身安全

- a) 保持警觉，当操作电动工具时关注所从事的操作并保持清醒。当你感到疲倦，或在有药物、酒精或治疗反应时，不要操作电动工具。
在操作电动工具时瞬间的疏忽会导致严重人身伤害。
- b) 使用个人防护装置。始终佩戴护目镜。
安全装置，诸如适当条件下使用防尘面具、防滑安全鞋、安全帽、听力防护等装置能减少人身伤害。
- c) 防止意外起动。确保开关在连接电源和 / 或电池盒、拿起或搬运工具时处于关断位置。
手指放在已接通电源的开关上或开关处于接通时插入插头可能会导致危险。
- d) 在电动工具接通之前，拿掉所有调节钥匙或扳手。
遗留在电动工具旋转零件上的扳手或钥匙会导致人身伤害。
- e) 手不要伸展得太长。时刻注意立足点和身体平衡。
这样在意外情况下能很好地控制电动工具。
- f) 着装适当。不要穿宽松衣服或佩戴饰品。让你的头发和衣服远离运动部件。
宽松衣服、佩饰或长发可能会卷入运动部件中。
- g) 如果提供了与排屑、集尘设备连接用的装置，要确保它们连接完好且使用得当。
使用这些装置可减少尘屑引起的危险。
- h) 请勿因频繁使用工具的熟悉感而掉以轻心，忽视工具的安全性原则。
粗心的行为可能会导致瞬间发生严重伤害。

4) 电动工具使用和注意事项

- a) 不要滥用电动工具，根据用途使用适当的电动工具。
选用适当设计的电动工具会使你工作更有效、更安全。
- b) 如果开关不能接通或关断工具电源，则不能使用该电动工具。
不能用开关来控制的电动工具是危险的且必须进行修理。
- c) 在进行任何调整、更换附件或存放电动工具之前，必须从电源上拔掉插头和 / 或取下电池盒（如果可拆卸）。
这种防护性措施将减少工具意外起动的危险。
- d) 将闲置不用的电动工具贮存在儿童所及范围之外，并且不要让不熟悉电动工具或对这些说明不了解的人操作电动工具。
电动工具在未经培训的用户手中是危险的。
- e) 维护电动工具和附件。检查运动件是否调整到位或卡住，检查零件破损情况和影响电动工具运行的其他状况。如有损坏，电动工具应在使用前修理好。
许多事故由维护不良的电动工具引发。
- f) 保持切削刀具锋利和清洁。
保养良好的有锋利切削刃的刀具不易卡住而且容易控制。
- g) 按照使用说明书，考虑作业条件和进行的作业来使用电动工具、附件和工具的刀头等。
将电动工具用于那些与其用途不符的操作可能会导致危险。
- h) 保持手柄和抓握表面干燥、清洁，远离油和油脂。
如果手柄和抓握表面湿滑，可能导致在发生意外情况时，无法安全操作和控制工具。

5) 电池式工具使用和注意事项

- a) 只用制造商规定的充电器充电。
将适用于某种电池盒的充电器用到其他电池盒时会发生着火危险。
- b) 只使用配有特制电池盒的电动工具。
使用其他电池盒会发生损坏和着火危险。
- c) 当电池盒不用时，将它远离其他金属物体，例如回形针、硬币、钥匙、钉子、螺钉或其他小金属物体，以防一端与另一端连接。
电池端部短路会引起燃烧或火灾。
- d) 在滥用条件下，液体会从电池中溅出；避免接触。如果无意间碰到了，用水冲洗。如果液体碰到了眼睛，还要寻求医疗帮助。
从电池中溅出的液体会发生腐蚀或燃烧。
- e) 请勿使用损坏或改装的电池盒或工具。
损坏或改装的电池可能会引发突发状况，导致火灾、爆炸或受伤。
- f) 请勿将电池盒或工具暴露在有火源或高温环境中。
如果暴露在有火源或130度以上高温的环境中，可能引起爆炸。

- g) 请完全按照充电说明进行操作，不要在说明中规定的温度范围外的环境中对电池盒或工具充电。
充电不当或在规定温度范围外的环境中充电可能会导致电池损坏，增加发生火灾的风险。

6) 维修

- a) 将你的电动工具送交专业维修人员，使用同样的备件进行修理。这样将确保所维修的电动工具的安全性。
- b) 请勿维修已损坏的电池盒。
需由制造商或经授权的服务供应商进行维修。

注意！

不可让儿童和体弱人士靠近工作场所。

应将不使用的工具存放在儿童和体弱人士接触不到的地方。

充电式多功能切割打磨机安全警告

1. 在执行切割附件会接触到暗线的操作时，通过绝缘的抓紧表面拿住电动工具。
接触“带电”电线的切割附件会使电动工具的裸露金属部件“带电”，并可能使操作员遭到电击。
2. 不要在潮湿的环境中使用本工具。
水或湿气进入工具可能会给操作者带来电击。

其他安全警告

1. 始终用一只手紧紧握住工具的外壳（图1）。不要触摸金属部分。



图1

2. 确保要切割的区域绝对没有任何隐藏的障碍物，包括电线、水或煤气管。切入上述物品可能导致触电或短路、气体泄漏或其他危险，可能造成严重事故或伤害。
3. 操作时请确保牢牢握住工具。
否则可能导致事故或受伤。

中文

4. 固定工件。使用夹紧装置或老虎钳固定工件比手更牢固。
5. 工作环境的准备和检查。请按下列注意事项检查工作环境是否适当。
6. 诸如二氧化硅或石棉的粉尘颗粒对你的健康有害。当与含有这些成分的材料一起工作时，要采取适当的防尘措施。
7. 与金属一起工作会引起火花。确保附近没有易燃物和可燃物，并将其存放在安全地点。
8. 在使用连续切割或研磨工作后，在更换电池时，请将设备休息15分钟左右。如果在更换电池后立刻开始作业，马达和开关等的温度将会升高，最终导致烧毁。
9. 工具过载时电机可能停止。如发生此种情况，请松开工具开关，并消除造成过载的原因。
10. 使用后不要立即接触应用工具、其连接区域或其他金属表面，因为它们会很热。否则可能会导致烧伤或受伤。金属仍处于高温状态，易灼伤皮肤。
11. 在高处操作工具时，要确保下面没有人。掉落的工具或材料可能导致事故或伤害。
12. 工作时不要对应用工具施加任何不合理的力量。这样做可能会破坏应用工具或损坏电机。
13. 不要让工具在无人看管的情况下在地板、桌子或其他地方运行。否则可能造成人员受伤。
14. 在安装应用工具时，要小心不要让手指或其他四肢被杠杆夹住。
15. 如果应用工具在安装到设备上后似乎松动或不平整，请重新安装工具。在应用工具松动或不平整的情况下操作设备可能会导致受伤。
16. 当打开工具时，确保应用工具没有接触到任何加工材料。否则可能导致受伤。
17. 为了提高切割效率，根据任务条件和要切割的材料切换应用工具的振动频率。
18. 使用后，确保在工具完全停止之前，不要将其放在碎片或锯屑附近，因为工具可能会吸进这些颗粒。
19. 请勿使用抛光金属的砂纸抛光木材。
20. 请勿使用磨损或堵塞的砂纸。
21. 务请在 0°C — 40°C 的温度下进行充电。
温度低于 0°C 将会导致充电过度，极其危险。电池不能在高于 40°C 的温度下充电。
最适合于充电的温度是 20°C — 25°C 。
22. 不要连续使用充电器。
一次充电完毕后，在15分钟内不要再次使用该充电器对电池充电。
23. 勿让杂质进入电池连结口内。
24. 切勿拆卸电池与充电器。
25. 切勿使电池短路。
使电池短路将会造成很大的电流和过热，从而烧坏电池。

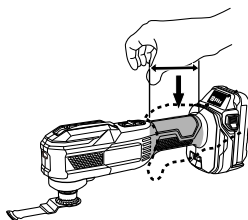
26. 请勿将电池丢入火中。
电池受热将会爆炸。
27. 请勿将异物插入充电器的通风口。
若将金属异物或易燃物插入通风口的话，将会引起触电事故或使充电器受损。
28. 充电后电池寿命太短不够使用时，请尽快将电池送往经销店。请勿将用过的电池乱丢。
29. 请勿使用耗竭了的电池，否则会损坏充电器。
30. 确认已紧紧装上电池。如果松弛则电池可能会脱开，并造成事故。
31. 请勿使用工具或电池端子（电池安装部位）明显变形的产品。
否则，安装电池后可能会短路，造成冒烟或起火。
32. 请清除工具端子（电池安装部位）上的削屑和灰尘。
 - 使用前请确保电池上没有堆积削屑和灰尘。
 - 在使用过程中，请尽量避免工具上的削屑或灰尘掉落在电池上。
 - 暂时不使用工具时或使用后，应将工具存放在不会掉落削屑或灰尘的地方。
否则可能短路，造成冒烟或起火。
33. 请在 -5°C - 40°C 环境下使用本工具及电池。

锂离子电池使用注意事项

为延长使用期限，锂离子电池配备停止输出的保护功能。

若是在使用本产品时发生下列 1 至 3 的情况，即使按下开关，马达也可能停止。这并非故障，而是启动保护功能的结果。

1. 在残留的电池电力即将耗尽时，马达会停止。
在这种情况下，请立即予以充电。
 2. 若工具超过负荷，马达亦可能停止。在这种情况下，请松开工具的开关，试着消除超过负荷的原因。之后您就可以再度使用。
 3. 若电池在过载工作情况下过热，电池电力可能会中止。
在这种情况下，请停止使用电池，让电池冷却。之后您就可以再度使用。
- 此外，请留心下列的警告及注意事项。

警告！

为防止发生电池漏电、发热、冒烟、爆炸及提前点燃，请确保留意下列事项。

1. 确保电池上没有堆积削屑及灰尘。
 - 在工作时确定削屑及灰尘没有掉落在电池上。
 - 确定所有工作时掉落在电动工具上的削屑和灰尘没有堆积在电池上。
 - 请勿将未使用的电池存放在曝露于削屑和灰尘的位置。
 - 在存放电池之前，请清除任何可能附着在上面的削屑和灰尘，并请切勿将它与金属零件（螺丝、钉子等）存放在一起。

中文

2. 请勿以钉子等利器刺穿电池、以铁锤敲打、踩踏、丢掷电池，或将其剧烈撞击。
3. 切勿使用明显损坏或变形的电池。
4. 请依规定方式使用电池，切勿移作他用。
5. 如果已过了再充电时间，电池仍无法完成充电，请立即停止继续再充电。
6. 请勿将电池放置于高温或高压处，例如微波炉、烘干机或高压容器内。
7. 在发觉有渗漏或异味时，请勿接近远离火源。
8. 请勿在会产生强烈静电的地方使用。
9. 如有电池渗漏、异味、发热、褪色或变形，或在使用、充电或存放时出现任何异常，请立即将它从装备或电池充电器拆下，并停止使用。
10. 请勿浸泡电池或让任何液体流入电池内部。导电液体进入（如水），可能造成电池损坏，甚至可导致火灾或爆炸。将电池存放在阴凉、干燥的地方，远离易燃物品。必须避免将电池置于腐蚀性气体环境中。

注意！

1. 若电池渗漏出的液体进入您的眼睛，请勿搓揉眼睛，并以自来水等干净清水充分冲洗，立刻送医。
若不加以处理，液体可能会导致眼睛不适。
2. 若液体渗漏至您的皮肤或衣物，请立即以自来水等清水冲洗。
上述情况可能会使皮肤受到刺激。
3. 若初次使用电池时发现生锈、异味、过热、褪色、变形及 / 或其它异常情况时，请勿使用并将该电池退还给供货商或厂商。

警告！

如果导电异物接触到锂离子电池的端子，电池可能短路，并导致火灾。存放锂离子电池时，请务必遵循下列注意事项。

- 切勿在存放盒中放置导电的残片，钉子，以及导线，如铁线和铜线。
- 为防止发生短路，应将电池装入工具中或者在存放时牢固地插入电池盖，直至看不到通风口。（参照图2）



图2

锂离子电池运输

当运输一个锂离子电池，请注意以下预防措施。

警告！

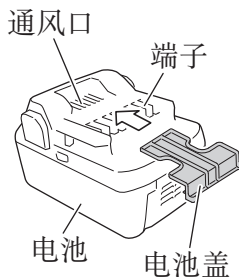
告知运输公司，包装内包含一个锂离子电池，告知该公司其功率输出并且要按照运输公司的指引安排运输。

- 功率输出超过100Wh的锂离子电池被视作危险物品运输分类并且需要特别申请程序。
- 对于境外运输，您必须遵守国际法以及输入国的规章和条例。



图3

符号

警告！

如下所示的符号用于本机。使用前请务必理解其含意。

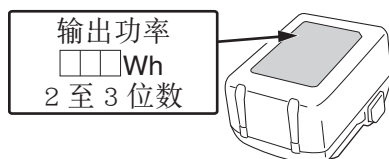
	为降低伤害风险，用户必须阅读使用说明书
V	额定电压
≡	直流电
n_0	空载转速
/min	每分钟的振动次数
	警告

零件名称

1. 电动工具



图4

2. 电池 (选购件)

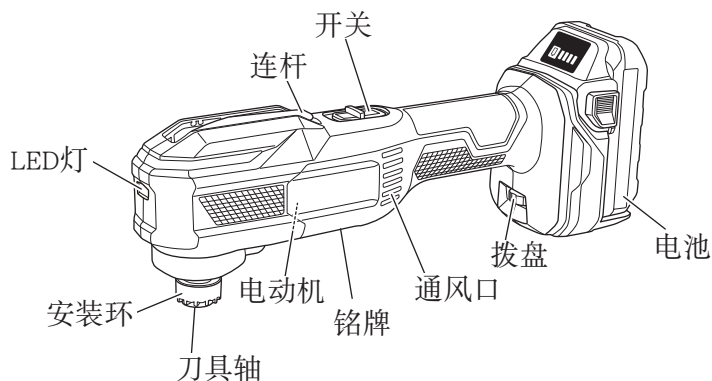
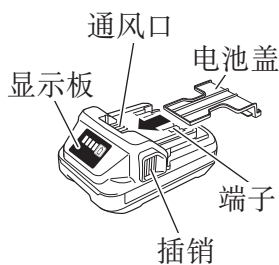

<BSL1820M>

图5

3. 电池充电器 (选购件)

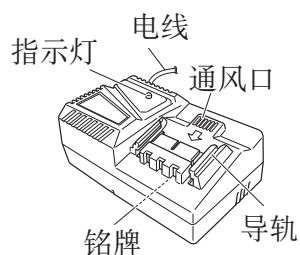

<UC18YFSL>

图6

规格

	CV18DA
电压	18V
空载振动频率	6000—20000/min
振动角度	3.6°
电池	BSL1820M: 锂离子18V (2.0Ah 5节)

重量	1.6kg (安装 BSL1820M)
----	---------------------

充电器

型式	UC18YFSL
充电电压	14.4 - 18V
重量	0.5kg

标准附件

除了主机 (1 台) 外, 产品包中还包括表中所列的附件。

表1

		CV18DA
		(NN)
	刀片	1

用途

- 各种材料的平面切削和斜面切削
- 瓷砖等的切削堵缝
- 木材等的抛光

电池及电池盖的拆卸、安装方法

1. 电池的拆卸法
请先紧抓住把手、然后再推压电池插销以拆下电池 (参照图7)。

注意！

切勿使电池短路。

中文

2. 电池的安装法

插入电池时请注意极性(参照图7)。



图7

充电

使用电动工具之前，按下述方法将电池进行充电。

<UC18YFSL>

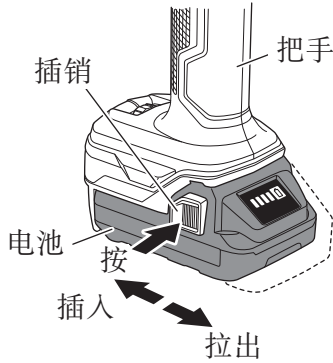
1. 将充电器的电源线连接到插座。
当充电器的插头接上插座时，充电状态灯将呈红色闪烁。(参照表2)
2. 将电池插入充电器。
如图8所示，将电池紧紧地插入充电器。



图8

3. 充电

将电池插入充电器后，将开始充电，指示灯会持续点亮呈红色。
电池完全充电后，指示灯将闪烁呈红色。(参照表2)

(1) 指示灯显示

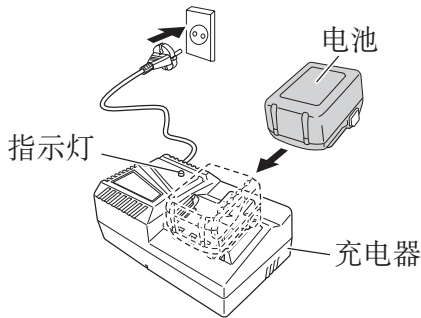
根据充电器或充电式电池的情况，指示灯的显示如表2所示。

表2: 指示灯的显示

每隔0.5秒开/关一次 	充电前*1或充电完成
连续点亮 	充电时
每隔0.5秒点亮1秒 	过热而等待*2
每隔0.1秒开/关一次 	无法充电*3

注:

*1 如果连好充电器后指示灯依旧闪烁红色，请检查并确认电池已完全插入。

*2 电池过热。无法充。

虽然继续放置在原处，电池将在冷却后开始充电，但最好是将电池取出并放置在阴凉、通风良好的位置处冷却。

*3 电池或充电器有问题。

– 请紧紧插入电池。

– 并确认电池安装部位或端部无异物堵塞。若无异物，则可能电池或充电器发生故障。请带去经授权的维修中心检查。

○ 如果指示灯未以红色闪烁，但充电电池电源线已连接至电源，表明充电器的保护电路可能已激活。拔下电源线或插座，然后等待 5分左右再次连接。如果指示灯仍未以红色闪烁，请将充电器送还至HiKOKI授权服务中心。

○ 连续使用时，电池充电器温度将提升，因此会导致出现故障。完成充电后，下次充电前，请让电池充电器休息 15 分钟。

(2) 关于电池的温度和充电时间（参照表3）

表3

型式	UC18YFSL
电池类型	锂离子电池
充电电压	14.4－18V

电池可充电温度		0°C – 50°C
电池容量的大致充电时间 (20°C下)	1.5Ah	22 分钟
	2.0Ah	30 分钟
	2.5Ah	35 分钟
	3.0Ah	45 分钟
	4.0Ah	60 分钟
	5.0Ah	75 分钟
	6.0Ah	90 分钟
多伏电池容量的大致充电时间(20°C下)	1.5Ah (×2节)	45 分钟
	2.5Ah (×2节)	75 分钟
	4.0Ah (×2节)	120 分钟
电池数量		4 – 10
重量		0.5kg

注:

- 充电时间可能会因环境温度和电源电压而异。
 - 充电时间较长
 - 环境温度过低时，充电时间会延长。请在温暖的场所中（如室内）给电池充电。
 - 请勿堵塞排气孔。否则会导致内部过热，从而降低充电器的性能。
 - 冷却扇未运转，请联系HiKOKI授权服务中心进行维修。
4. 从电源插座拔下充电器的电源线。
 5. 握紧充电器并取出电池。

注:

充电后，先将电池从充电器中取出，然后妥善保存。

关于新电池的放电。

新电池内部的化学物质未被激活或电池长时间不使用时，初次或第二次使用时需要将其放电至较低电量。这只是暂时现象，将电池充电2-3次即可恢复为充电所需的正常时间。

较长时间保持电池性能的方法

- (1) 在电池电力完全耗尽之前进行充电。
感到电动工具的能力变弱时，请停止使用并给电池充电。若您继续使用电动工具并耗尽电力，电池可能会损坏或其使用寿命缩短。
- (2) 避免在高温环境中充电。
使用后可充电电池的温度将迅速升高。若使用后立即对这种电池进行充电，其内部化学物质会劣化，电池使用寿命将缩短。请稍等片刻，待电池冷却后再进行充电。

作业之前

警告！

为避免发生严重事故，请确保开关处于关断位置，并取出电池。

1. 准备和检查工作环境
确认工作场所满足使用注意事项中所述的所有条件。
2. 电源开关
确认电源开关处于“关”的位置。
若电源开关接通，则安装电池后，电动工具将出其不意地立刻转动，从而导致严重事故。
3. 更换应用工具

注意！

- 请勿在使用后立即触摸应用工具。金属仍处于高温状态，易灼伤皮肤。
- 杠杆连接在一个强大的弹簧上。在推下杠杆时要非常小心，不要夹到手指。

注：

- 确保应用工具的方向是正确的。
- 确保应用工具正确地设置在连接环的突起上。

中文

(1) 拉起杠杆。(图9)



图9

(2) 拉出工具轴，同时逆时针旋转。(图10)

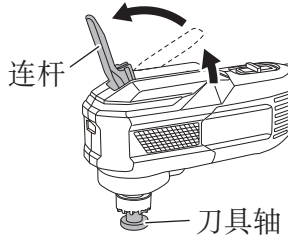

图10

(3) 将应用工具安装到连接环上，确保工具的孔与连接环的突起相吻合。应用工具的连接角度可以以 30° 为单位设置。(图11)

(4) 牢固地插入工具轴，同时顺时针旋转。(图11)



图11

(5) 向下推杆。(图12)

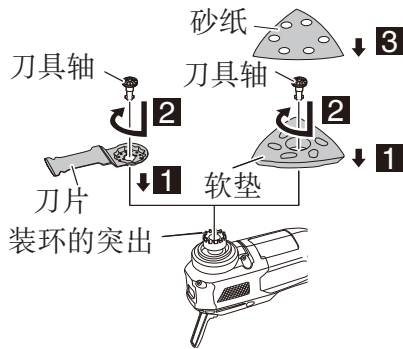

图12

(6) 将砂纸粘在砂垫上时，要对准孔。(图11)

4. 确认开关在“关”位置

注意！

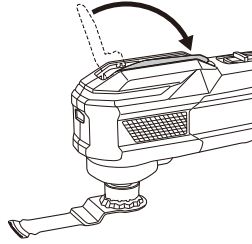
在安装或拆卸电池之前，将开关转到“关”位置。

如果在开关处于“开”位置的情况下插入电池，马达会意外地运转。

5. 检查电池的插入

注意！

请确保电池装入正确的位置，直至发出喀嗒声，否则可能会使电池突然掉落，导致使用者或周围人员受伤。

操作

警告！

- 在下列情况下，请务必关闭开关，然后从工具中取出电池：
 - 停止或结束工作时
 - 安装或拆除附件或可选部件时
 - 维护、检查或储存工具时
- 在操作过程中，请勿将脸或手靠近设备的应用工具。

注意！

- 为延长使用期限，锂离子电池配备停止输出的保护功能。因此，如果工具过载，马达可能停止。不过，这只是保护功能作用的结果，而不是故障。在此情况下，松开工具的开关，消除造成过载的原因。
- 启动应用工具时，请勿使其与其它任何正在加工的材料接触。这可能导致人员受伤。
- 根据作业条件和切割材料可调整应用工具的速度来提高切割效率。

中文

- 操作应用工具时请勿施加任何不必要的压力。这可能会损坏应用工具。
- 使用后，在应用工具完全停止前请勿将其放置在靠近碎片或锯屑附近的位置，应用工具可能卷进碎屑等而被卡住。

1. 开关操作

将开关朝前滑动将打开 **I**，同时激活LED灯，使应用工具发光。（图13）
要关闭主机，请将开关滑向 **O**。



图13

注意！

- 请不要看着灯，让眼睛直接受灯光照射。如果眼睛持续受灯光照射，会伤害眼睛。
- 用一块软布擦去附着在 LED 灯镜头上的任何灰尘或污垢，注意不要刮擦镜头。LED 灯镜头上的刮擦会导致亮度降低。

2. 调整操作速度（图14）

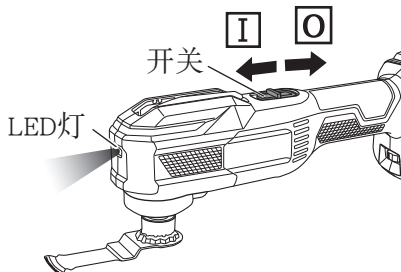
你可以通过调整 "1" 到 "6" 的转盘来改变6000到20000/min的振动频率。

将转盘调整到最适合你的工作条件和材料的速度。



图14

3. 检查附件

- 检查应用工具是否是制造商推荐的真正组件，是否有裂缝或其他损坏。
- 检查应用工具是否按照指示正确安装。

4. 切割、锯切和刮削

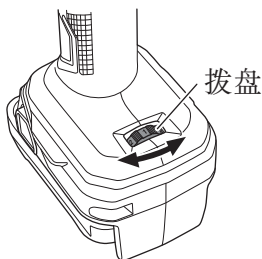
锯和刮的任务需要特定的应用工具（单独出售）。

- (1) 开启设备，用转盘设置应用工具的速度。（图15）
- (2) 将涂抹工具轻轻放在材料上，并以运动不慢的速度向前移动涂抹工具。（图15）



图15

5. 打磨

打磨任务需要特定的应用工具（单独出售）。

- (1) 打开设备，使用转盘设置应用工具的速度。（图16）
- (2) 将涂抹工具轻轻放在材料上，并以不减慢运动的速度来回移动涂抹工具。（图16）

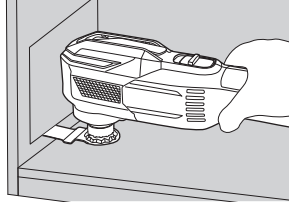
注意！

- 请勿使用抛光金属的砂纸抛光木材。
- 请勿使用磨损或堵塞的砂纸。



图16

砂光机的提示

- 如何放置砂纸
将工具轻轻地按压在加工材料的表面，确保砂纸完全覆盖该表面。施加不必要的压力会对电机产生压力，同时缩短砂纸的使用寿命并降低抛光效率。
- 如何移动工具
用手重复地来回推拉。

- 新的粗砂纸，砂砾较粗
新的粗砂纸砂砾较粗，可能会导致装置抽动。在作业开始时，稍微将装置向前或向后倾斜一会，并保持倾斜的位置。随着砂纸慢慢适应这项作业，抽动就会消失。
- 直到把加工表面抛
使用同一等级的砂纸直至加工表面被均匀抛光。
在作业未完成时更换不同等级的砂纸可能导致抛光表面不均匀。
- 测试
在开始一项任务之前，建议你用多余的材料来检查振动频率。

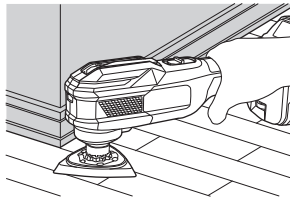
6. 剩余电池电量指示灯

可以按下剩余电池电量指示灯开关点亮指示灯，查看电池的剩余电量。

(图17, 表4)

环境温度和电池状态可能会对剩余电池电量产生轻微的影响，因此，建议您仅将指示灯作为参考。

此外，电动工具或充电器上的剩余电池电量指示灯可能有所不同。

剩余电池电
量指示灯 剩余电池电量
指示灯开关



图17

表4

	点亮; 电池剩余电量超过75%。
	点亮; 电池剩余电量为50%—75%
	点亮; 电池剩余电量为25%—50%
	点亮; 电池剩余电量超过25%。

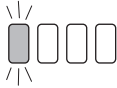
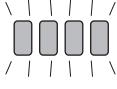
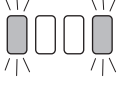
	<p>闪烁； 电池剩余电量即将耗尽。请尽快对电池进行充电。</p>
	<p>闪烁； 因高温暂停输出。从电动工具中取下电池，让电池完全冷却。</p>
	<p>闪烁； 因失败或故障暂停输出。电池可能出现故障，请与经销商联系。</p>

环境温度和电池特性不同，则所显示的电池剩余电量也会有些许不同，以上内容仅供参考。

注意！

请勿强烈撞击或破坏开关面板。否则可能会导致故障。

应用工具的选择

○ 应用工具

为确保最佳的操作效率和结果，重要的一点是根据切割材料的类型和厚度选择最适合的刀片。

有关详细信息请联系HiKOKI授权服务中心。

维护和检查

警告！

检查或维护前，请务必关闭开关并取出电池。

1. 检查应用工具

继续使用变钝或受损的应用工具会导致切割效率下降并可能导致电机过载。一旦发现过度磨损，请立即更换使用新的应用工具。

2. 检查安装螺钉

要经常检查安装螺钉是否紧固妥善。若发现螺钉松了，应立即重新扭紧，否则会导致严重的事故。

3. 检查端子（工具和电池）

确保端子上没有堆积削屑和灰尘。

在操作前、操作时和操作后需要时常检查。

注意！

请清除端子上的削屑或灰尘。否则可能导致故障。

4. 清理外部

电动工具脏污时，请用柔软的干布或沾有肥皂水的布片擦拭。切勿使用氯溶液、汽油或稀释剂，以免塑胶部分溶化。

5. 电动机的维护

电动机绕线是电动工具的“心脏部”应仔细检查有无损伤，是否被油液或水沾湿。

6. 收藏

请将电动工具和电池存放在温度低于40℃且儿童无法触及的环境下。

注:

存放锂离子电池

在存放前请确保电池已完全充电。

电池在低电量的状态下长时间存放(3个月或更长)，可能会导致电池性能劣化，使用时间明显减少或无法进行充电。

但是，即使是使用时间明显减少的电池，通过反复充电和使用2~5次，有时也可恢复使用时间。

若反复充电和使用后电池的使用时间仍非常短，请认作为电池已达到了使用寿命并更换新的电池。

注意！

在操作和维修电动工具时，必须遵守贵国制定的安全的有关规则和标准。

关于HiKOKI牌无线电动工具的重要通知：

请确保始终使用我们指定的正版电池。如果使用我们指定以外的电池，或对电池进行拆卸和改动（例如拆卸和更换电池组件或其他内部部件），那么我们无法保证我们无线电动工具的安全性和使用性能。

选择附件

根据特定作业选择适合的附件。
有关详细信息请联系HiKOKI授权服务中心。

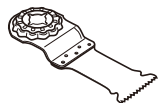

MSW32PC: 782733

MSD32PBC: 782721

MSM32PB: 782714

MSM20PB: 782712

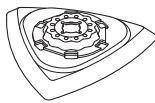

MSU93D

产品编号: 782791

砂板

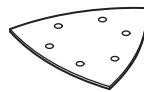

#60, 80, 100,
120, 180, 240
砂纸

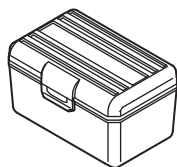

产品编号: 337685
附件箱

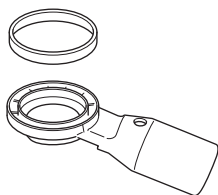

产品编号: 376066
集尘适配器套装



产品编号: 376118
毛毡包装

注:
仅可与MSU93D 砂板一同
使用。

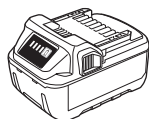

BSL18.:
电池

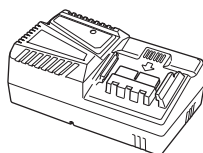

UC18YFSL
(14.4V-18V)
充电器

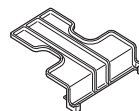

产品编号: 329897
电池盖

CONTENTS

GENERAL POWER TOOL SAFETY WARNINGS.....	24
CORDLESS MULTI TOOL SAFETY WARNINGS.....	27
ADDITIONAL SAFETY WARNINGS.....	27
CAUTION ON LITHIUM-ION BATTERY.....	29
REGARDING LITHIUM-ION BATTERY TRANSPORTATION.....	31
SYMBOLS.....	32
NAME OF PARTS.....	33
SPECIFICATIONS.....	33
STANDARD ACCESSORIES.....	34
APPLICATIONS.....	34
REMOVAL AND INSTALLATION METHOD OF BATTERY.....	34
CHARGING.....	35
PRIOR TO OPERATION.....	38
OPERATION.....	40
SELECTION OF APPLICATION TOOL.....	44
MAINTENANCE AND INSPECTION.....	44
SELECTING ACCESSORIES.....	46

GENERAL POWER TOOL SAFETY WARNINGS

WARNING

Read all safety warnings, instructions, illustrations and specifications provided with this power tool.

Failure to follow all instructions listed below may result in electric shock, fire and/or serious injury.

Save all warnings and instructions for future reference.

The term “power tool” in the warnings refers to your mains-operated (corded) power tool or battery-operated (cordless) power tool.

- 1) **Work area safety**
 - a) **Keep work area clean and well lit.**
Cluttered or dark areas invite accidents.
 - b) **Do not operate power tools in explosive atmospheres, such as in the presence of flammable liquids, gases or dust.**
Power tools create sparks which may ignite the dust or fumes.
 - c) **Keep children and bystanders away while operating a power tool.**
Distractions can cause you to lose control.
- 2) **Electrical safety**
 - a) **Power tool plugs must match the outlet. Never modify the plug in any way. Do not use any adapter plugs with earthed (grounded) power tools.**
Unmodified plugs and matching outlets will reduce risk of electric shock.

- b) **Avoid body contact with earthed or grounded surfaces, such as pipes, radiators, ranges and refrigerators.**
There is an increased risk of electric shock if your body is earthed or grounded.
- c) **Do not expose power tools to rain or wet conditions.**
Water entering a power tool will increase the risk of electric shock.
- d) **Do not abuse the cord. Never use the cord for carrying, pulling or unplugging the power tool. Keep cord away from heat, oil, sharp edges or moving parts.**
Damaged or entangled cords increase the risk of electric shock.
- e) **When operating a power tool outdoors, use an extension cord suitable for outdoor use.**
Use of a cord suitable for outdoor use reduces the risk of electric shock.
- f) **If operating a power tool in a damp location is unavoidable, use a residual current device (RCD) protected supply.**
Use of an RCD reduces the risk of electric shock.

3) Personal safety

- a) **Stay alert, watch what you are doing and use common sense when operating a power tool. Do not use a power tool while you are tired or under the influence of drugs, alcohol or medication.**
A moment of inattention while operating power tools may result in serious personal injury.
- b) **Use personal protective equipment. Always wear eye protection.**
Protective equipment such as a dust mask, non-skid safety shoes, hard hat or hearing protection used for appropriate conditions will reduce personal injuries.
- c) **Prevent unintentional starting. Ensure the switch is in the off-position before connecting to power source and/or battery pack, picking up or carrying the tool.**
Carrying power tools with your finger on the switch or energising power tools that have the switch on invites accidents.
- d) **Remove any adjusting key or wrench before turning the power tool on.**
A wrench or a key left attached to a rotating part of the power tool may result in personal injury.
- e) **Do not overreach. Keep proper footing and balance at all times.**
This enables better control of the power tool in unexpected situations.
- f) **Dress properly. Do not wear loose clothing or jewellery. Keep your hair and clothing away from moving parts.**
Loose clothes, jewellery or long hair can be caught in moving parts.
- g) **If devices are provided for the connection of dust extraction and collection facilities, ensure these are connected and properly used.**
Use of dust collection can reduce dust-related hazards.
- h) **Do not let familiarity gained from frequent use of tools allow you to become complacent and ignore tool safety principles.**
A careless action can cause severe injury within a fraction of a second.

4) Power tool use and care

- a) **Do not force the power tool. Use the correct power tool for your application.**

The correct power tool will do the job better and safer at the rate for which it was designed.

- b) **Do not use the power tool if the switch does not turn it on and off.**
Any power tool that cannot be controlled with the switch is dangerous and must be repaired.
- c) **Disconnect the plug from the power source and/ or remove the battery pack, if detachable, from the power tool before making any adjustments, changing accessories, or storing power tools.**
Such preventive safety measures reduce the risk of starting the power tool accidentally.
- d) **Store idle power tools out of the reach of children and do not allow persons unfamiliar with the power tool or these instructions to operate the power tool.**
Power tools are dangerous in the hands of untrained users.
- e) **Maintain power tools and accessories. Check for misalignment or binding of moving parts, breakage of parts and any other condition that may affect the power tool's operation. If damaged, have the power tool repaired before use.**
Many accidents are caused by poorly maintained power tools.
- f) **Keep cutting tools sharp and clean.**
Properly maintained cutting tools with sharp cutting edges are less likely to bind and are easier to control.
- g) **Use the power tool, accessories and tool bits etc. in accordance with these instructions, taking into account the working conditions and the work to be performed.**
Use of the power tool for operations different from those intended could result in a hazardous situation.
- h) **Keep handles and grasping surfaces dry, clean and free from oil and grease.**
Slippery handles and grasping surfaces do not allow for safe handling and control of the tool in unexpected situations.

5) **Battery tool use and care**

- a) **Recharge only with the charger specified by the manufacturer.**
A charger that is suitable for one type of battery pack may create a risk of fire when used with another battery pack.
- b) **Use power tools only with specifically designated battery packs.**
Use of any other battery packs may create a risk of injury and fire.
- c) **When battery pack is not in use, keep it away from other metal objects, like paper clips, coins, keys, nails, screws or other small metal objects, that can make a connection from one terminal to another.**
Shorting the battery terminals together may cause burns or a fire.
- d) **Under abusive conditions, liquid may be ejected from the battery; avoid contact. If contact accidentally occurs, flush with water. If liquid contacts eyes, additionally seek medical help.**
Liquid ejected from the battery may cause irritation or burns.
- e) **Do not use a battery pack or tool that is damaged or modified.**

Damaged or modified batteries may exhibit unpredictable behaviour resulting in fire, explosion or risk of injury.

- f) **Do not expose a battery pack or tool to fire or excessive temperature.**
Exposure to fire or temperature above 130°C may cause explosion.
- g) **Follow all charging instructions and do not charge the battery pack or tool outside the temperature range specified in the instructions.**
Charging improperly or at temperatures outside the specified range may damage the battery and increase the risk of fire.

6) Service

- a) **Have your power tool serviced by a qualified repair person using only identical replacement parts.**
This will ensure that the safety of the power tool is maintained.
- b) **Never service damaged battery packs.**
Service of battery packs should only be performed by the manufacturer or authorized service providers.

CAUTION

Keep children and infirm persons away.

When not in use, tools should be stored out of reach of children and infirm persons.

CORDLESS MULTI TOOL SAFETY WARNINGS

1. **Hold the power tool by insulated gripping surfaces, when performing an operation where the cutting accessory may contact hidden wiring.**
Cutting accessory contacting a "live" wire may make exposed metal parts of the power tool "live" and could give the operator an electric shock.
2. **Don't use this tool in wet applications.**
Water or moisture entering the tool could give the operator an electric shock.

ADDITIONAL SAFETY WARNINGS

1. **Always hold the tool firmly with one hand on housing (Fig. 1). Do not touch the metal part.**

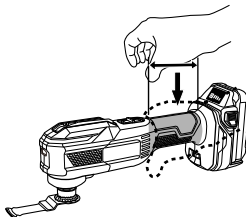

Fig. 1

English

2. **Make sure that the area to be cut is absolutely free of any hidden obstructions including electrical wiring, water, or gas pipes. Cutting into the aforementioned may result in electric shock or short circuit, gas leak or other hazards that can cause serious accidents or injuries.**
3. **Make sure to securely hold the tool during operation. Failure to do so can result in accidents or injuries.**
4. **Secure the workpiece. A workpiece clamped with clamping devices or in a vice is held more secure than by hand.**
5. **Setting up and checking the work environment. Check if the work environment is suitable by following the precaution.**
6. **Dust particles such as silica or asbestos are hazardous to your health. When working with materials containing these components, take appropriate dust-proofing measures.**
7. **Working with metal can cause sparks. Make sure there are no flammable and combustible materials in the vicinity and that they are stored in a safe location.**
8. **After use for continuous cutting or grinding works, rest the unit for 15 minutes or so when replacing the battery. The temperature of the motor, switch, etc., will rise if the work is started again immediately after battery replacement, eventually resulting in burnout.**
9. **The motor may stop in the event the tool is overloaded. In this should occur, release the tool's switch and eliminate the cause of the overload.**
10. **Do not touch the application tool, its attachment area or other metal surfaces immediately after use as they will be hot. Doing so may result in burns or injury. The metal is hot and can easily burn your skin.**
11. **Make sure that there is no one below when operating the tool in high locations. Dropping the tool or materials may result in accident or injury.**
12. **Never apply any unreasonable force to the application tool when working. Doing so may break the application tool or damage the motor.**
13. **Do not leave the tool running unattended on the floor, table or other locations. Doing so may result in injury.**
14. **When attaching application tools, be careful not to get your fingers or other extremities caught in the lever.**
15. **If the application tool seems to be loose or uneven after attaching it to the unit, re-attach the tool. Operating the unit with a loose or uneven application tool may result in injury.**
16. **When switching on the tool, make sure the application tool is not in contact with any processing materials. Failure to do so may result in injury.**
17. **For cutting efficiency, switch the vibration frequency of the application tool according to task conditions and materials to be cut.**
18. **After use, be sure not to place the tool near chips or sawdust before it comes to a full stop as the tool may suck in those particles.**
19. **Do not polish wood with sanding paper used for metal polishing.**
20. **Do not use worn or clogged sanding paper.**

21. Always charge the battery at a temperature of 0–40°C.
A temperature of less than 0°C will result in over charging which is dangerous. The battery cannot be charged at a temperature greater than 40°C.
The most suitable temperature for charging is that of 20–25°C.
22. Do not use the charger continuously.
When one charging is completed, leave the charger for about 15 minutes before the next charging of battery.
23. Do not allow foreign matter to enter the hole for connecting the battery.
24. Never disassemble the battery and charger.
25. Never short-circuit the battery.
Short-circuiting the battery will cause a great electric current and overheat. It results in burn or damage to the battery.
26. Do not dispose of the battery in fire.
If the battery burnt, it may explode.
27. Do not insert object into the air ventilation slots of the charger.
Inserting metal objects or inflammables into the charger air ventilation slots will result in electrical shock hazard or damaged charger.
28. Bring the battery to the shop from which it was purchased as soon as the post-charging battery life becomes too short for practical use. Do not dispose of the exhausted battery.
29. Using an exhausted battery will damage the charger.
30. Make sure that the battery is installed firmly. If it is at all loose it could come off and cause an accident.
31. Do not use the product if the tool or the battery terminals (battery mount) are deformed.
Installing the battery could cause a short circuit that could result in smoke emission or ignition.
32. Keep the tool's terminals (battery mount) free of swarf and dust.
 - Prior to use, make sure that swarf and dust have not collected in the area of the terminals.
 - During use, try to avoid swarf or dust on the tool from falling on the battery.
 - When suspending operation or after use, do not leave the tool in an area where it may be exposed to falling swarf or dust.
Doing so could cause a short circuit that could result in smoke emission or ignition.
33. Always use the tool and battery at temperatures between -5°C and 40°C.

CAUTION ON LITHIUM-ION BATTERY

To extend the lifetime, the lithium-ion battery equips with the protection function to stop the output.

In the cases of 1 to 3 described below, when using this product, even if you are pulling the switch, the motor may stop. This is not the trouble but the result of protection function.

English

1. When the battery power remaining runs out, the motor stops.
In such a case, charge it up immediately.
2. If the tool is overloaded, the motor may stop. In this case, release the switch of tool and eliminate causes of overloading. After that, you can use it again.
3. If the battery is overheated under overload work, the battery power may stop.
In this case, stop using the battery and let the battery cool. After that, you can use it again.

Furthermore, please heed the following warning and caution.

WARNING

In order to prevent any battery leakage, heat generation, smoke emission, explosion and ignition beforehand, please be sure to heed the following precautions.

1. Make sure that swarf and dust do not collect on the battery.
 - During work make sure that swarf and dust do not fall on the battery.
 - Make sure that any swarf and dust falling on the power tool during work do not collect on the battery.
 - Do not store an unused battery in a location exposed to swarf and dust.
 - Before storing a battery, remove any swarf and dust that may adhere to it and do not store it together with metal parts (screws, nails, etc.).
2. Do not pierce battery with a sharp object such as a nail, strike with a hammer, step on, throw or subject the battery to severe physical shock.
3. Do not use an apparently damaged or deformed battery.
4. Do not use the battery for a purpose other than those specified.
5. If the battery charging fails to complete even when a specified recharging time has elapsed, immediately stop further recharging.
6. Do not put or subject the battery to high temperatures or high pressure such as into a microwave oven, dryer, or high pressure container.
7. Keep away from fire immediately when leakage or foul odor are detected.
8. Do not use in a location where strong static electricity generates.
9. If there is battery leakage, foul odor, heat generated, discolored or deformed, or in any way appears abnormal during use, recharging or storage, immediately remove it from the equipment or battery charger, and stop use.
10. Do not immerse the battery or allow any fluids to flow inside. Conductive liquid ingress, such as water, can cause damage resulting in fire or explosion. Store your battery in a cool, dry place, away from combustible and flammable items. Corrosive gas atmospheres must be avoided.

CAUTION

1. If liquid leaking from the battery gets into your eyes, do not rub your eyes and wash them well with fresh clean water such as tap water and contact a doctor immediately.
If left untreated, the liquid may cause eye-problems.
2. If liquid leaks onto your skin or clothes, wash well with clean water such as tap water immediately.
There is a possibility that this can cause skin irritation.

3. If you find rust, foul odor, overheating, discolor, deformation, and/or other irregularities when using the battery for the first time, do not use and return it to your supplier or vendor.

WARNING

If a conductive foreign matter enters in the terminal of lithium ion battery, the battery may be shorted, causing fire. When storing the lithium ion battery, obey surely the rules of following contents.

- Do not place conductive debris, nail and wires such as iron wire and copper wire in the storage case.
- Either install the battery in the power tool or store by securely pressing into the battery cover until the ventilation holes are concealed to prevent short-circuits (See Fig. 2).

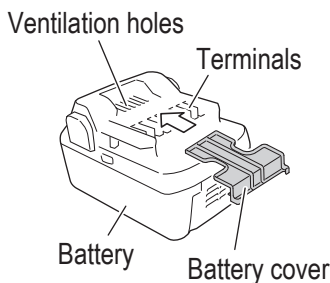

Fig. 2

REGARDING LITHIUM-ION BATTERY TRANSPORTATION

When transporting a lithium-ion battery, please observe the following precautions.

WARNING

Notify the transporting company that a package contains a lithium-ion battery, inform the company of its power output and follow the instructions of the transportation company when arranging transport.

- Lithium-ion batteries that exceed a power output of 100 Wh are considered to be in the freight classification of Dangerous Goods and will require special application procedures.

English

- For transportation abroad, you must comply with international law and the rules and regulations of the destination country.

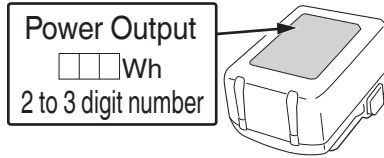





Fig. 3

SYMBOLS

WARNING

The following show symbols used for the machine. Be sure that you understand their meaning before use.

	To reduce the risk of injury, user must read instruction manual.
V	Rated voltage
	Direct current
n_0	No-load speed
/min	Oscillation per minute
	Warning

NAME OF PARTS

1. POWER TOOL

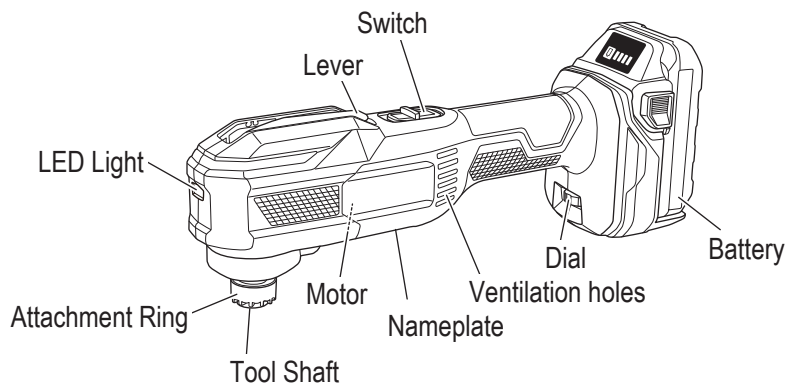
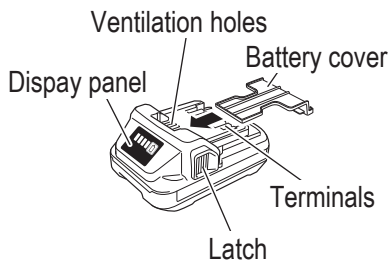

Fig. 4

2. Battery (Optional accessories)



<BSL1820M>

Fig. 5

3. Battery Charger (Optional accessories)

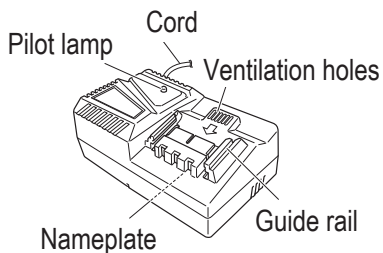

<UC18YFSL>

Fig. 6

SPECIFICATIONS

	CV18DA
Voltage	18 V
No Load Vibration Frequency	6000–20000 /min
Oscillation angle	3.6°
Battery	BSL1820M: Li-ion 18 V (2.0 Ah 5 cells)
Weight	1.6 kg (BSL1820M attached)

English

CHARGER

Model	UC18YFSL
Charging voltage	14.4–18 V
Weight	0.5 kg

STANDARD ACCESSORIES

In addition to the main unit (1 unit), the package contains the accessories listed in the below.

Table 1

		CV18DA
		(NN)
	Blade	1

APPLICATIONS

- Flush cutting and pocket cutting of various materials
- Peeling of tiles, caulking, etc.
- Polishing wood materials, etc.

REMOVAL AND INSTALLATION METHOD OF BATTERY

1. Battery removal
Hold the handle tightly and push the battery latches to remove the battery (see **Fig. 7**).

CAUTION

Never short-circuit the battery.

- Battery installation
Insert the battery while observing its polarities (see **Fig. 7**).

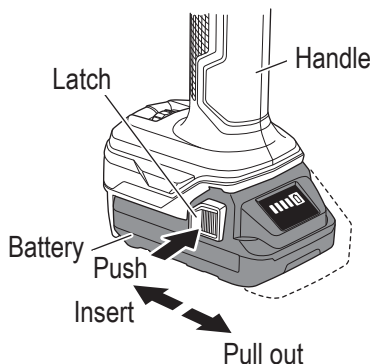

Fig. 7

CHARGING

Before using the power tool, charge the battery as follows.

<UC18YFSL>

- Connect the charger's power cord to the receptacle.
When connecting the plug of the charger to a receptacle, the pilot lamp will blink in red (See **Table 2**).
- Insert the battery into the charger.
Firmly insert the battery into the charger as shown in **Fig. 8**.

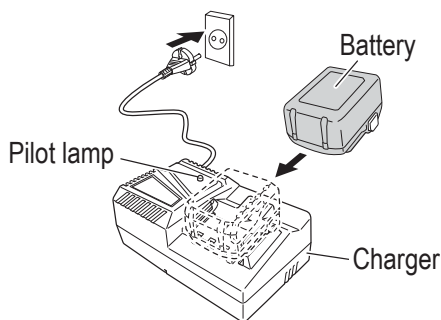

Fig. 8





- Charging
When inserting a battery in the charger, charging will commence and the pilot lamp will light continuously in red.
When the battery becomes fully recharged, the pilot lamp will blink in red. (See **Table 2**)

English

(1) Pilot lamp indication

The indications of the pilot lamp will be as shown in **Table 2**, according to the condition of the charger or the rechargeable battery.

Table 2: Indications of the pilot lamp

ON/OFF at 0.5 sec. intervals 	Before charging*1 or Charging complete
Lights continuously 	While charging
Lights for 1 sec. at intervals of 0.5 sec. 	Overheat standby*2
ON/OFF at 0.1 sec. intervals 	Charging impossible*3

NOTE

- *1 If the red lamp continues to blink even after the charger has been attached, check to confirm that the battery has been fully inserted.
 - *2 Battery overheated. Unable to charge.
Although charging will start once the battery has cooled down even when left in situ, the best practice is to remove the battery and allow it to cool down in a shaded, well-ventilated location before charging.
 - *3 Malfunction in the battery or the charger
 - Fully insert the battery.
 - Check to confirm that no foreign matter is stuck to the battery mount or terminals. If there are no foreign objects, it is probable that the battery or charger is malfunctioning. Take it to your authorized Service Center.
- If the pilot lamp does not blink in red even though the charger cord is connected to the power, it indicates that the protection circuit of the charger may be activated. Remove the cord or plug from the power and then connect it again after 5 minutes or so. If this does not cause the pilot lamp to blink in red, please take the charger to the HIKOKI Authorized Service Center.
- When the battery charger has been continuously used, the battery charger will be heated, thus constituting the cause of the failures. Once the charging has been completed, give 15 minutes rest until the next charging.

(2) Regarding the temperatures and charging time of the battery (See **Table 3**)

Table 3

Model	UC18YFSL
Type of battery	Li-ion

Charging voltage	14.4–18 V	
Temperatures at which the battery can be recharged	0°C–50°C	
Charging time for battery capacity, approx. (At 20°C)	1.5 Ah	22 min
	2.0 Ah	30 min
	2.5 Ah	35 min
	3.0 Ah	45 min
	4.0 Ah	60 min
	5.0 Ah	75 min
	6.0 Ah	90 min
Charging time for multi volt battery capacity, approx. (At 20°C)	1.5 Ah (× 2 unit)	45 min
	2.5 Ah (× 2 unit)	75 min
	4.0 Ah (× 2 unit)	120 min
Number of battery cells	4–10	
Weight	0.5 kg	

NOTE

- The recharging time may vary according to the ambient temperature and power source voltage.
 - If charging takes a long time
 - Charging will take longer at extremely low ambient temperatures. Charge the battery in a warm location (such as indoors).
 - Do not block the air vent. Otherwise the interior will overheat, reducing the charger's performance.
 - If the cooling fan is not operating, contact a HiKOKI Authorized Service Center for repairs.
4. Disconnect the charger's power cord from the receptacle.
 5. Hold the charger firmly and pull out the battery.

NOTE

Be sure to pull out the battery from the charger after use, and then keep it.

English

Regarding electric discharge in case of new batteries, etc.

As the internal chemical substance of new batteries and batteries that have not been used for an extended period is not activated, the electric discharge might be low when using them the first and second time. This is a temporary phenomenon, and normal time required for recharging will be restored by recharging the batteries 2–3 times.

How to make the batteries perform longer.

- (1) Recharge the batteries before they become completely exhausted.
When you feel that the power of the tool becomes weaker, stop using the tool and recharge its battery. If you continue to use the tool and exhaust the electric current, the battery may be damaged and its life will become shorter.
- (2) Avoid recharging at high temperatures.
A rechargeable battery will be hot immediately after use. If such a battery is recharged immediately after use, its internal chemical substance will deteriorate, and the battery life will be shortened. Leave the battery and recharge it after it has cooled for a while.

PRIOR TO OPERATION

WARNING

To avoid serious accident, ensure the switch is in the OFF position, and pull out the battery.

1. Preparing and checking the work environment
Make sure that the work site meets all the conditions laid forth in the precautions.
2. Power switch
Ensure that the power switch is in the OFF position.
If the battery is installed while the power switch is in the ON position, the power tool will start operating immediately, which could cause a serious accident.
3. Changing application tools

CAUTION

- **Never touch the application tool immediately after use. The metal is hot and can easily burn your skin.**
- **The lever is attached to a strong spring. Be very careful not to get your fingers caught when pushing the lever down.**

NOTE

- Make sure the facing of the application tool is correct.
- Make sure the application tool is properly set on the protrusion of the attachment ring.

- (1) Pull the lever up. (**Fig. 9**)

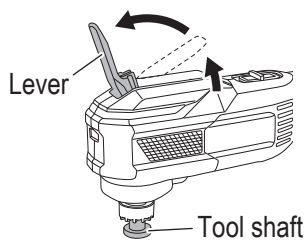

Fig. 9

- (2) Pull out the tool shaft while rotating it counterclockwise. (**Fig. 10**)

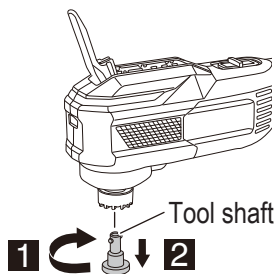

Fig. 10

- (3) Attach the application tool to the attachment ring, making sure the tool's hole is fitted to the ring's protrusion. The angle of attachment for the application tool can be set in 30° increments. (**Fig. 11**)
- (4) Firmly insert the tool shaft while rotating it clockwise. (**Fig. 11**)

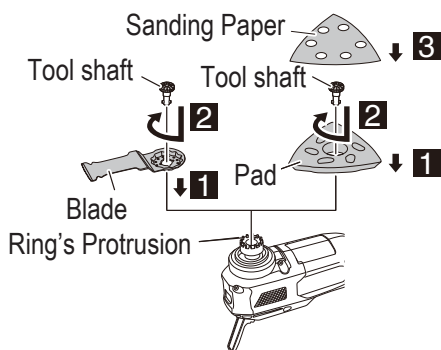

Fig. 11

English

- (5) Push down the lever. (Fig. 12)

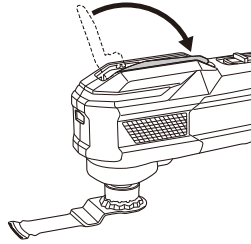

Fig. 12

- (6) Align the holes when sticking the sanding paper to the sanding pad. (Fig. 11)
4. Confirm the switch is in OFF position

CAUTION

Before installing or removing the battery, turn the switch to the OFF position. If the battery is inserted with the switch in the ON position, the motor will operate unexpectedly.

5. Check battery insertion

CAUTION

Until the battery locks in place with a little click, if not, it may accidentally fall out of the tool causing injury to you or someone around you.

OPERATION

WARNING

- Be sure to turn off the switch, then remove the battery from the tool in the following situations:
 - When stopping or ending work
 - When attaching or removing accessories or optional parts
 - When maintaining, inspecting, or storing the tool
- During operation, do not place your face or hands near the application tool of the unit.

CAUTION

- To extend the lifetime, the lithium-ion battery equips with the protection function to stop the output. Therefore, if the tool is overloaded, the motor may stop. However, this is not the trouble but the result of protection function. In this case, release the switch of tool and eliminate the causes of overloading.
- When switching on the tool, make sure the application tool is not in contact with the material to be processed. Failure to do so may result in injury.

- For cutting efficiency, switch the speed of the application tool according to task conditions and materials to be cut.
- Do not apply any unnecessary pressure when operating the tool. Doing so may damage the application tool.
- After use, be sure not to place the tool near chips or sawdust before it comes to a full stop as the tool may suck in those particles.

1. Switch operation

Sliding the switch towards **I** will switch on, simultaneously activating the LED light which will light the application tool. (Fig. 13)

To turn the main unit off, slide the switch towards **O**.

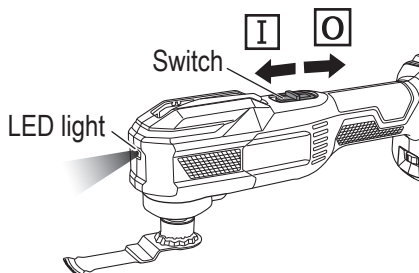

Fig. 13

CAUTION

- Do not expose directly your eye to the light by looking into the light. If your eye is continuously exposed to the light, your eye will be hurt.
- Wipe off any dirt or grime attached to the lens of the LED light with a soft cloth, being careful not to scratch the lens. Scratches on the lens of the LED light can result in decreased brightness.

2. Adjusting operating speed (Fig. 14)

You can change the vibration frequency between 6000 to 20000 /min by adjusting the dial from "1" to "6".

Adjust the dial for the speed that best suits your task conditions and materials.

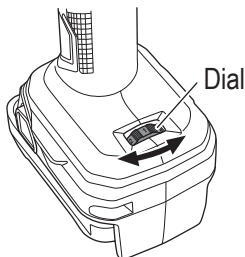

Fig. 14

3. Checking the Accessory

English

- Check to see if the application tool is a genuine component recommended by the manufacturer and that there are no cracks or other damage.
 - Check to see if the application tool is properly installed as instructed.
4. Cutting, sawing and scraping
Sawing and scraping tasks require specific application tools (sold separately).
- (1) Switch the unit on and use the dial to set the speed of the application tool. (**Fig. 15**)
 - (2) Lightly place the application tool on the material and move the application tool forward at a pace where the movement isn't slowed. (**Fig. 15**)

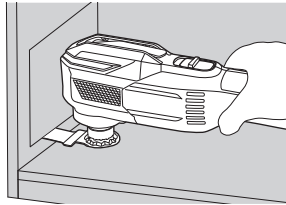

Fig. 15

5. Sanding
Sanding tasks require specific application tools (sold separately).
- (1) Switch the unit on and use the dial to set the speed of the application tool. (**Fig. 16**)
 - (2) Lightly place the application tool on the material and move the application tool back and forth at a pace where the movement isn't slowed. (**Fig. 16**)

CAUTION

- Do not polish wood with sanding paper used for metal polishing.
- Do not use worn or clogged sanding paper.

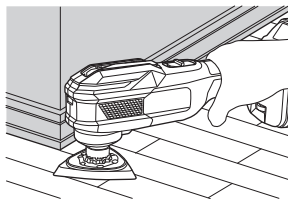

Fig. 16

Tips on SANDING

- How to place the sandpaper
Lightly press the tool to the surface to be processed; making sure that the sandpaper is evenly applied to the surface. Applying unnecessary pressure will place stress on the motor and shorten the sandpaper's life, reducing polishing efficiency.

- How to move the tool
Using your hand, repeatedly push out and pull back in a back and forth motion.
- New coarse sandpaper with rougher grit
New coarse sandpaper with rougher grit may cause the unit to jerk. During the start of the task, slightly tilt the unit towards the front or back for a while, maintaining the tilted position. The jerking will stop as the sandpaper adapts to the task.
- Until the surface being processed is polished
Use the same grade of sandpaper until the surface being processed is evenly polished. Switching to a different grade of sandpaper when the task is not completed may result in an uneven finish.
- Testing
Before starting a task, it is recommended that you check the vibration frequency using excess material.

6. Remaining battery indicator

You can check the battery's remaining capacity by pressing the remaining battery indicator switch to light the indicator lamp. (Fig. 17, Table 4)

It is best to use the remaining battery indicator as a guide since there are slight differences such as ambient temperature and the condition of the battery.

Also, the remaining battery indicator may vary from those equipped to a tool or charger.

Remaining battery indicator lamp Remaining battery indicator switch

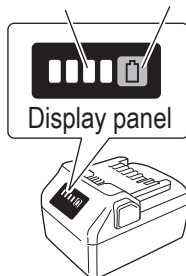
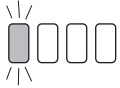
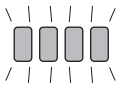
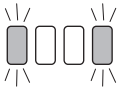

Fig. 17

Table 4

	Lights ; The battery remaining power is over 75%.
	Lights ; The battery remaining power is 50%–75%.
	Lights ; The battery remaining power is 25%–50%.
	Lights ; The battery remaining power is less than 25%.

English

	Blinks ; The battery remaining power is nearly empty. Recharge the battery soonest possible.
	Blinks ; Output suspended due to high temperature. Remove the battery from the tool and allow it to fully cool down.
	Blinks ; Output suspended due to failure or malfunction. The problem may be the battery so please contact your dealer.

As the remaining battery indicator shows somewhat differently depending on ambient temperature and battery characteristics, read it as a reference.

CAUTION

Do not give a strong shock to the switch panel or break it. It may lead to a trouble.

SELECTION OF APPLICATION TOOL

- Application tools
To ensure maximum operating efficiency and results, it is very important to select the appropriate blade best suited to the type and thickness of the material to be cut.
For details contact HiKOKI Authorized Service Center.

MAINTENANCE AND INSPECTION

WARNING

Be sure to turn off the switch and pull out the battery before doing any inspection or maintenance.

1. Inspecting the application tool
Continued use of a dull or damaged application tool will result in reduced cutting efficiency and may cause overloading of the motor. Replace the application tool with new one as soon as excessive abrasion is noted.
2. Inspecting the mounting screws
Regularly inspect all mounting screws and ensure that they are properly tightened. Should any of the screws be loose, retighten them immediately. Failure to do so may result in serious hazard.

3. Inspection of terminals (tool and battery)
Check to make sure that swarf and dust have not collected on the terminals.
On occasion check prior, during and after operation.

CAUTION

Remove any swarf or dust which may have collected on the terminals. Failure to do so may result in malfunction.

4. Cleaning on the outside
When the power tool is stained, wipe with a soft dry cloth or a cloth moistened with soapy water. Do not use chloric solvents, gasoline or paint thinner, for they melt plastics.
5. Maintenance of the motor
The motor unit winding is the very “heart” of the power tool.
Exercise due care to ensure the winding does not become damaged and/or wet with oil or water.
6. Storage
Store the power tool and battery in a place in which the temperature is less than 40°C, and out of reach of children.

NOTE

Storing Lithium-ion Batteries

Make sure the batteries have been fully charged before storing them.

Prolonged storage (3 months or more) of batteries with a low charge may result in performance deterioration, significantly reducing battery usage time or rendering the batteries incapable of holding a charge.

However, significantly reduced battery usage time may be recovered by repeatedly charging and using the batteries two to five times.

If the battery usage time is extremely short despite repeated charging and use, consider the batteries dead and purchase new batteries.

CAUTION

In the operation and maintenance of power tools, the safety regulations and standards prescribed in each country must be observed.

Important notice on the batteries for the HiKOKI cordless power tools

Please always use one of our designated genuine batteries. We cannot guarantee the safety and performance of our cordless power tool when used with batteries other than these designated by us, or when the battery is disassembled and modified (such as disassembly and replacement of cells or other internal parts).

SELECTING ACCESSORIES

Select accessories that are suited to a specific task.
For details contact HiKOKI Authorized Service Center.

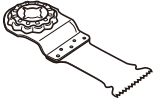

MSW32PC : 782733
MSD32PBC : 782721
MSM32PB : 782714
MSM20PB : 782712

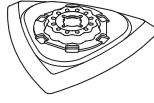

MSU93D
Part Number: 782791
Sanding plate

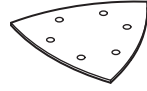

#60, 80, 100,
120, 180, 240
Sanding paper

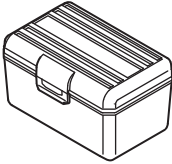

Part Number: 337685
Accessory case

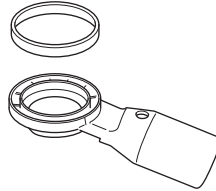

Part Number: 376066
Dust collection adapter set



Part Number: 376118
Felt packing

NOTE

Intended for use only with the
MSU93D sanding plate.

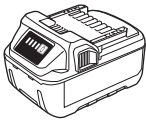

BSL18..
Battery

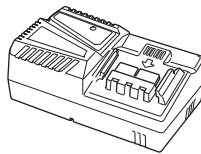

UC18YFSL
(14.4 V-18V)
Charger

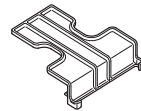

Part Number: 329897
Battery cover

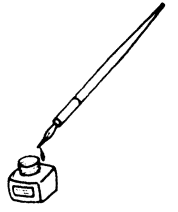

服务中心
高壹工机商业(上海)有限公司
上海市闵行区浦江工业园区三鲁路3585号7幢3楼

制造商
广东高壹工机有限公司
广东省广州市番禺区化龙镇工业路富裕围工业村

Koki Holdings Co., Ltd.

306
编号: C99749621 G
发行日期: 2023年6月
中国印刷