

C3607DB

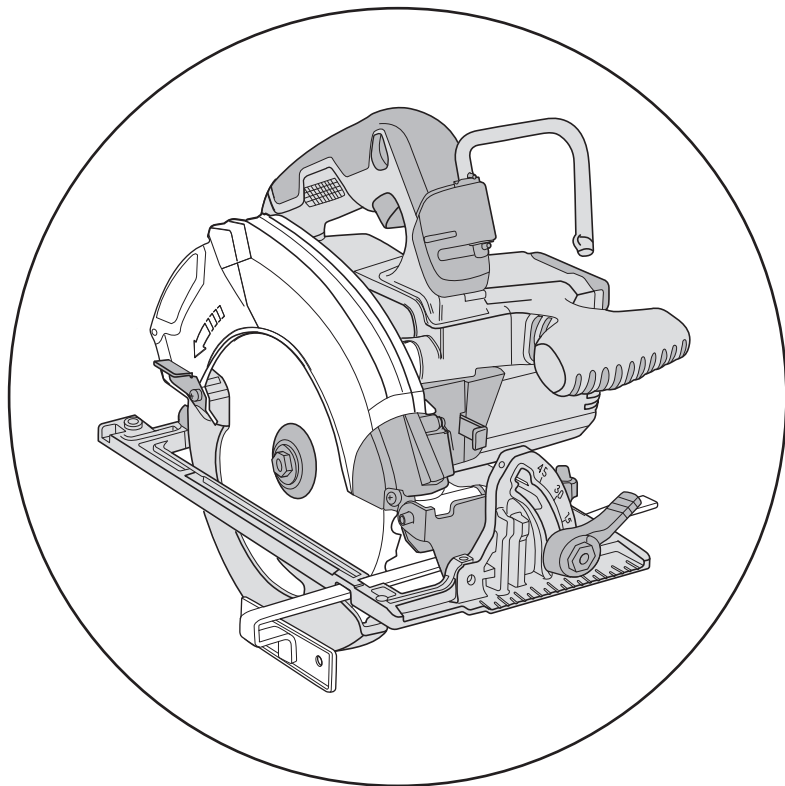

en Handling instructions

zh 使用說明書

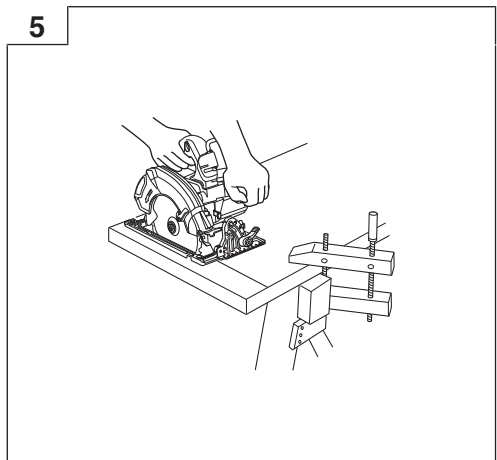
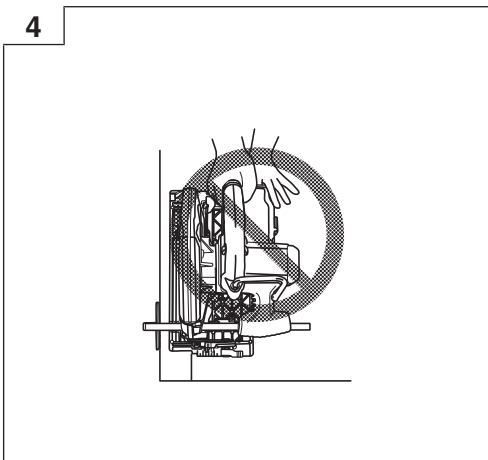
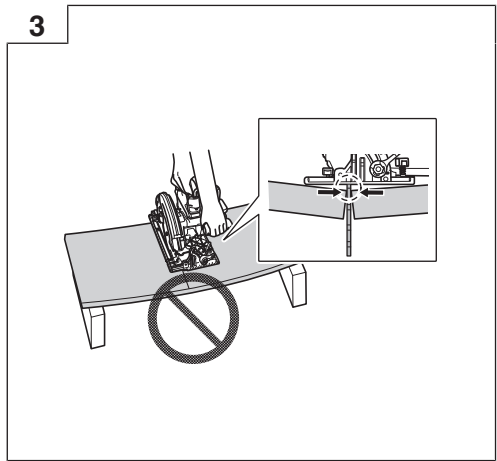
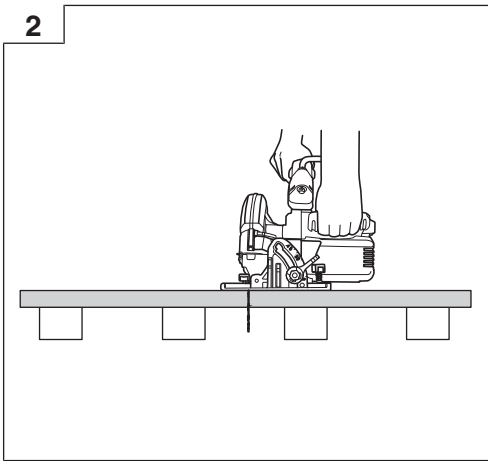
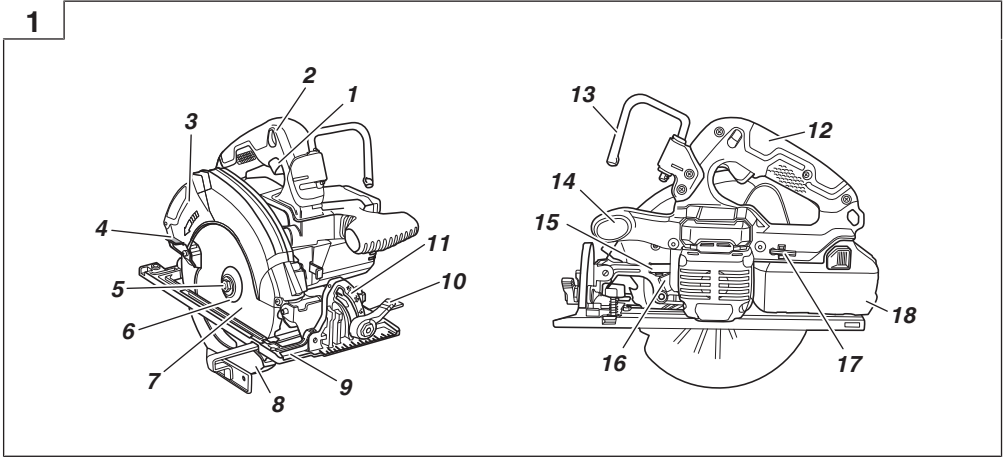

6

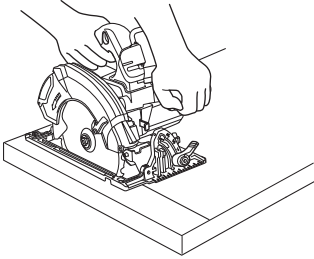

7

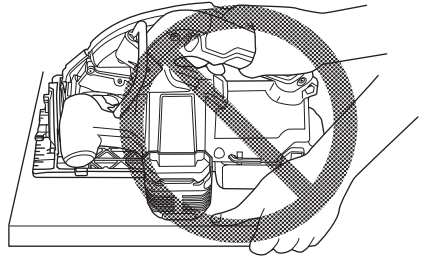

8

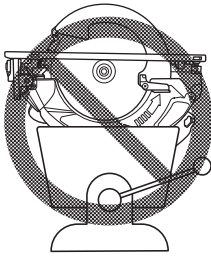

9

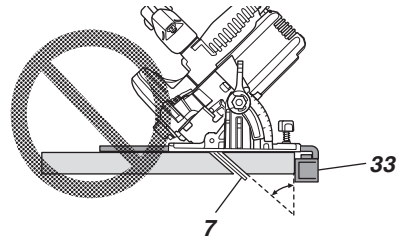

10

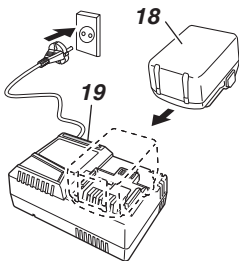

11

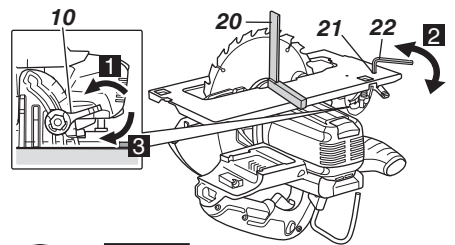

12

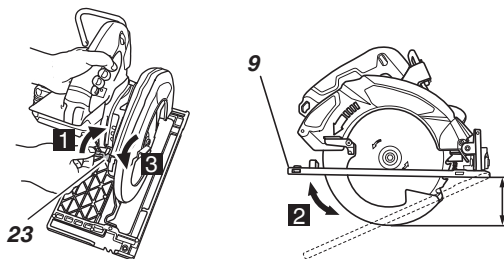

13

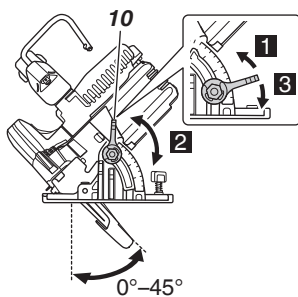

14

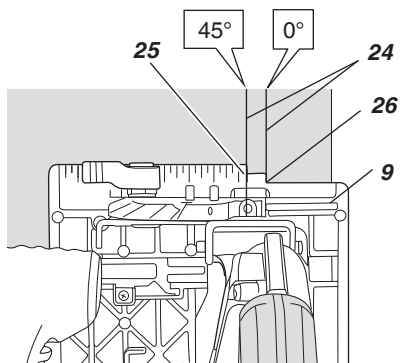

15

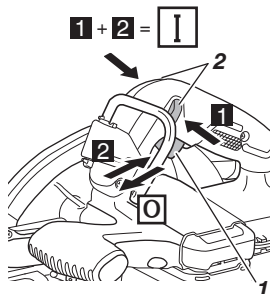

16

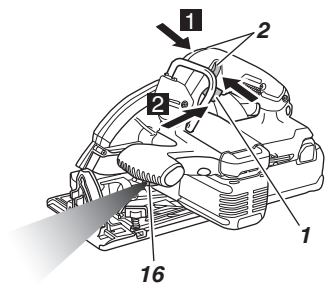

17

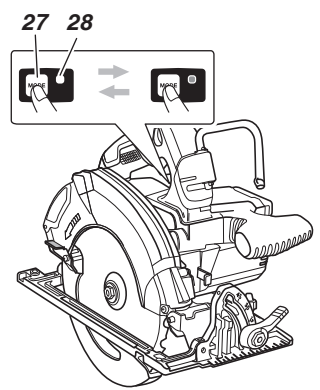

18

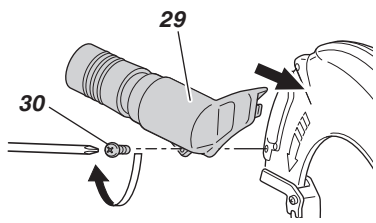

19

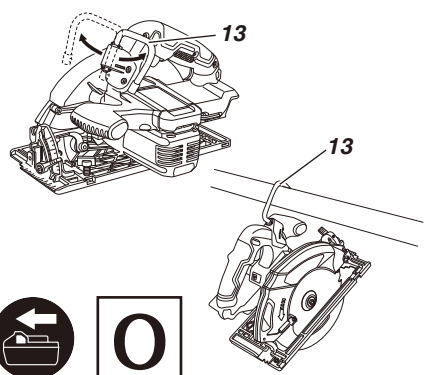

20

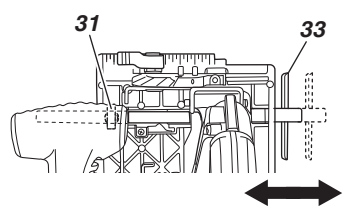
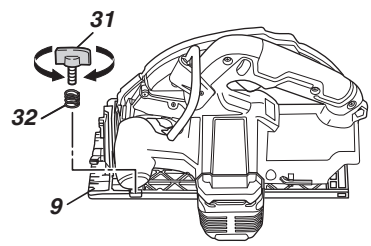

21

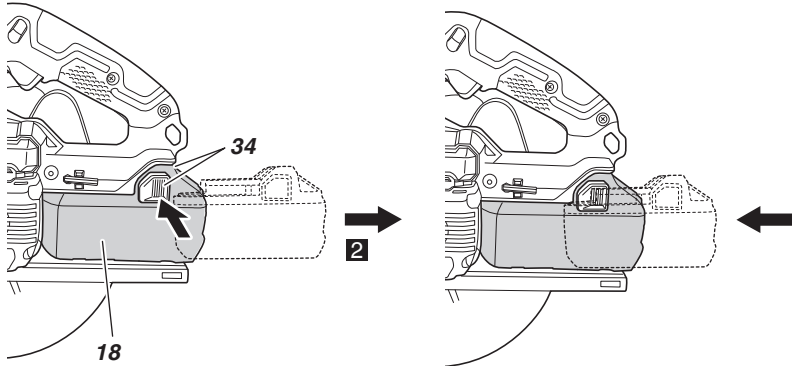

22

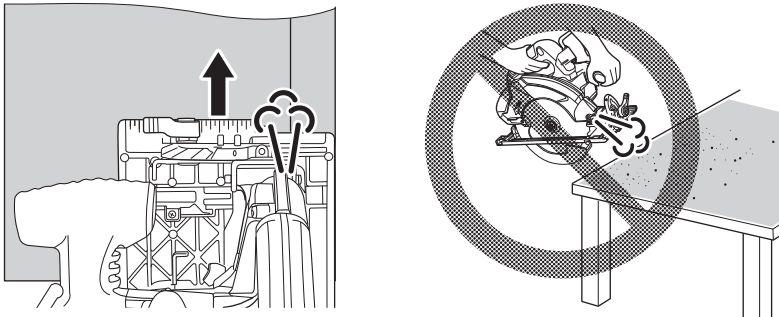

23

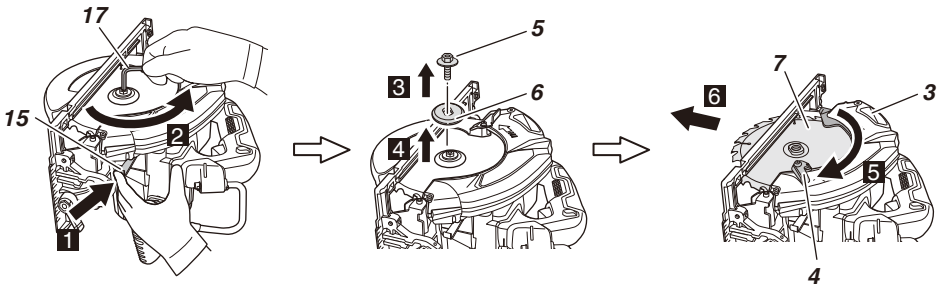

24

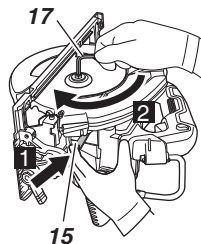
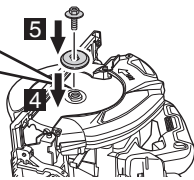
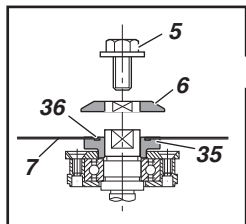
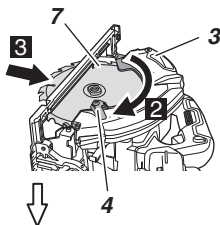
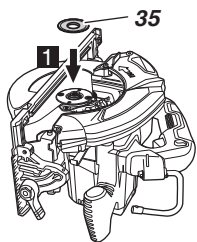

25

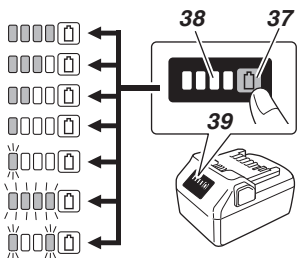

GENERAL POWER TOOL SAFETY WARNINGS

WARNING

Read all safety warnings, instructions, illustrations and specifications provided with this power tool.

Failure to follow all instructions listed below may result in electric shock, fire and/or serious injury.

Save all warnings and instructions for future reference.

The term "power tool" in the warnings refers to your mains-operated (corded) power tool or battery-operated (cordless) power tool.

1) Work area safety

- a) **Keep work area clean and well lit.**
Cluttered or dark areas invite accidents.
- b) **Do not operate power tools in explosive atmospheres, such as in the presence of flammable liquids, gases or dust.**
Power tools create sparks which may ignite the dust or fumes.
- c) **Keep children and bystanders away while operating a power tool.**
Distractions can cause you to lose control.

2) Electrical safety

- a) **Power tool plugs must match the outlet. Never modify the plug in any way. Do not use any adapter plugs with earthed (grounded) power tools.**
Unmodified plugs and matching outlets will reduce risk of electric shock.
- b) **Avoid body contact with earthed or grounded surfaces, such as pipes, radiators, ranges and refrigerators.**
There is an increased risk of electric shock if your body is earthed or grounded.
- c) **Do not expose power tools to rain or wet conditions.**
Water entering a power tool will increase the risk of electric shock.
- d) **Do not abuse the cord. Never use the cord for carrying, pulling or unplugging the power tool. Keep cord away from heat, oil, sharp edges or moving parts.**
Damaged or entangled cords increase the risk of electric shock.
- e) **When operating a power tool outdoors, use an extension cord suitable for outdoor use.**
Use of a cord suitable for outdoor use reduces the risk of electric shock.
- f) **If operating a power tool in a damp location is unavoidable, use a residual current device (RCD) protected supply.**
Use of an RCD reduces the risk of electric shock.

3) Personal safety

- a) **Stay alert, watch what you are doing and use common sense when operating a power tool. Do not use a power tool while you are tired or under the influence of drugs, alcohol or medication.**
A moment of inattention while operating power tools may result in serious personal injury.
- b) **Use personal protective equipment. Always wear eye protection.**
Protective equipment such as a dust mask, non-skid safety shoes, hard hat or hearing protection used for appropriate conditions will reduce personal injuries.

- c) **Prevent unintentional starting. Ensure the switch is in the off-position before connecting to power source and/or battery pack, picking up or carrying the tool.**
Carrying power tools with your finger on the switch or energising power tools that have the switch on invites accidents.
 - d) **Remove any adjusting key or wrench before turning the power tool on.**
A wrench or a key left attached to a rotating part of the power tool may result in personal injury.
 - e) **Do not overreach. Keep proper footing and balance at all times.**
This enables better control of the power tool in unexpected situations.
 - f) **Dress properly. Do not wear loose clothing or jewellery. Keep your hair and clothing away from moving parts.**
Loose clothes, jewellery or long hair can be caught in moving parts.
 - g) **If devices are provided for the connection of dust extraction and collection facilities, ensure these are connected and properly used.**
Use of dust collection can reduce dust-related hazards.
 - h) **Do not let familiarity gained from frequent use of tools allow you to become complacent and ignore tool safety principles.**
A careless action can cause severe injury within a fraction of a second.
- #### 4) Power tool use and care
- a) **Do not force the power tool. Use the correct power tool for your application.**
The correct power tool will do the job better and safer at the rate for which it was designed.
 - b) **Do not use the power tool if the switch does not turn it on and off.**
Any power tool that cannot be controlled with the switch is dangerous and must be repaired.
 - c) **Disconnect the plug from the power source and/ or remove the battery pack, if detachable, from the power tool before making any adjustments, changing accessories, or storing power tools.**
Such preventive safety measures reduce the risk of starting the power tool accidentally.
 - d) **Store idle power tools out of the reach of children and do not allow persons unfamiliar with the power tool or these instructions to operate the power tool.**
Power tools are dangerous in the hands of untrained users.
 - e) **Maintain power tools and accessories. Check for misalignment or binding of moving parts, breakage of parts and any other condition that may affect the power tool's operation. If damaged, have the power tool repaired before use.**
Many accidents are caused by poorly maintained power tools.
 - f) **Keep cutting tools sharp and clean.**
Properly maintained cutting tools with sharp cutting edges are less likely to bind and are easier to control.
 - g) **Use the power tool, accessories and tool bits etc. in accordance with these instructions, taking into account the working conditions and the work to be performed.**
Use of the power tool for operations different from those intended could result in a hazardous situation.
 - h) **Keep handles and grasping surfaces dry, clean and free from oil and grease.**

Slippery handles and grasping surfaces do not allow for safe handling and control of the tool in unexpected situations.

5) Battery tool use and care

a) Recharge only with the charger specified by the manufacturer.

A charger that is suitable for one type of battery pack may create a risk of fire when used with another battery pack.

b) Use power tools only with specifically designated battery packs.

Use of any other battery packs may create a risk of injury and fire.

c) When battery pack is not in use, keep it away from other metal objects, like paper clips, coins, keys, nails, screws or other small metal objects, that can make a connection from one terminal to another.

Shorting the battery terminals together may cause burns or a fire.

d) Under abusive conditions, liquid may be ejected from the battery; avoid contact. If contact accidentally occurs, flush with water. If liquid contacts eyes, additionally seek medical help.

Liquid ejected from the battery may cause irritation or burns.

e) Do not use a battery pack or tool that is damaged or modified.

Damaged or modified batteries may exhibit unpredictable behaviour resulting in fire, explosion or risk of injury.

f) Do not expose a battery pack or tool to fire or excessive temperature.

Exposure to fire or temperature above 130°C may cause explosion.

g) Follow all charging instructions and do not charge the battery pack or tool outside the temperature range specified in the instructions.

Charging improperly or at temperatures outside the specified range may damage the battery and increase the risk of fire.

6) Service

a) Have your power tool serviced by a qualified repair person using only identical replacement parts.

This will ensure that the safety of the power tool is maintained.

b) Never service damaged battery packs.

Service of battery packs should only be performed by the manufacturer or authorized service providers.

PRECAUTION

Keep children and infirm persons away. When not in use, tools should be stored out of reach of children and infirm persons.

CORDLESS CIRCULAR SAW SAFETY WARNINGS

Cutting procedures

a) ⚠ DANGER : Keep hands away from cutting area and the blade. Keep your second hand on auxiliary handle, or motor housing.

If both hands are holding the saw, they cannot be cut by the blade.

b) Do not reach underneath the workpiece.

The guard cannot protect you from the blade below the workpiece.

c) Adjust the cutting depth to the thickness of the workpiece.

Less than a full tooth of the blade teeth should be visible below the workpiece.

d) Never hold the workpiece in your hands or across your leg while cutting. Secure the workpiece to a stable platform.

It is important to support the work properly to minimize body exposure, blade binding, or loss of control.

e) Hold the power tool by insulated gripping surfaces, when performing an operation where the cutting tool may contact hidden wiring or its own cord.

Contact with a "live" wire will also make exposed metal parts of the power tool "live" and could give the operator an electric shock.

f) When ripping, always use a rip fence or straight edge guide.

This improves the accuracy of cut and reduces the chance of blade binding.

g) Always use blades with correct size and shape (diamond versus round) of arbour holes.

Blades that do not match the mounting hardware of the saw will run off-centre, causing loss of control.

h) Never use damaged or incorrect blade washers or bolt.

The blade washers and bolt were specially designed for your saw, for optimum performance and safety of operation.

Kickback causes and related warnings

- kickback is a sudden reaction to a pinched, jammed or misaligned saw blade, causing an uncontrolled saw to lift up and out of the workpiece toward the operator;
- when the blade is pinched or jammed tightly by the kerf closing down, the blade stalls and the motor reaction drives the unit rapidly back toward the operator;
- if the blade becomes twisted or misaligned in the cut, the teeth at the back edge of the blade can dig into the top surface of the wood causing the blade to climb out of the kerf and jump back toward the operator.

Kickback is the result of saw misuse and/or incorrect operating procedures or conditions and can be avoided by taking proper precautions as given below.

a) Maintain a firm grip with both hands on the saw and position your arms to resist kickback forces. Position your body to either side of the blade, but not in line with the blade.

Kickback could cause the saw to jump backwards, but kickback forces can be controlled by the operator, if proper precautions are taken.

b) When blade is binding, or when interrupting a cut for any reason, release the trigger and hold the saw motionless in the material until the blade comes to a complete stop.

Never attempt to remove the saw from the work or pull the saw backward while the blade is in motion or kickback may occur.

Investigate and take corrective actions to eliminate the cause of blade binding.

c) When restarting a saw in the workpiece, centre the saw blade in the kerf so that the saw teeth are not engaged into the material.

If a saw blade binds, it may walk up or kickback from the workpiece as the saw is restarted.

d) Support large panels to minimise the risk of blade pinching and kickback.

English

Large panels tend to sag under their own weight. Supports must be placed under the panel on both sides, near the line of cut and near the edge of the panel.

- e) **Do not use dull or damaged blades.**
Unsharpened or improperly set blades produce narrow kerf causing excessive friction, blade binding and kickback.
- f) **Blade depth and bevel adjusting locking levers must be tight and secure before making the cut.**
If blade adjustment shifts while cutting, it may cause binding and kickback.
- g) **Use extra caution when sawing into existing walls or other blind areas.**
The protruding blade may cut objects that can cause kickback.

Lower guard function

- a) **Check the lower guard for proper closing before each use. Do not operate the saw if the lower guard does not move freely and close instantly. Never clamp or tie the lower guard into the open position.**
If the saw is accidentally dropped, the lower guard may be bent.
Raise the lower guard with the retracting handle and make sure it moves freely and does not touch the blade or any other part, in all angles and depths of cut.
- b) **Check the operation of the lower guard spring. If the guard and the spring are not operating properly, they must be serviced before use.**
Lower guard may operate sluggishly due to damaged parts, gummy deposits, or a build-up of debris.
- c) **The lower guard may be retracted manually only for special cuts such as “plunge cuts” and “compound cuts”. Raise the lower guard by the retracting handle and as soon as the blade enters the material, the lower guard must be released.**
For all other sawing, the lower guard should operate automatically.
- d) **Always observe that the lower guard is covering the blade before placing the saw down on bench or floor.**
An unprotected, coasting blade will cause the saw to walk backwards, cutting whatever is in its path. Be aware of the time it takes for the blade to stop after switch is released.

ADDITIONAL SAFETY WARNINGS

- 1. Wear earplugs to protect your ears during operation.
 - 2. Use only blade diameter specified on the machine.
 - 3. Do not use any abrasive wheel.
 - 4. Do not use saw blades which are deformed or cracked.
 - 5. Do not use saw blades made of high speed steel.
 - 6. Do not use saw blades which do not comply with the characteristics specified in these instructions.
 - 7. Do not stop the saw blades by lateral pressure on the disc.
 - 8. Always keep the saw blades sharp.
 - 9. Ensure that the lower guard moves smoothly and freely.
 - 10. Never use the circular saw with its lower guard fixed in the open position.
 - 11. Ensure that the retraction mechanism of the guard system operates correctly.
 - 12. Never operate the circular saw with the saw blade turned upward or to the side.
 - 13. Ensure that the material is free of foreign matters such as nails.
 - 14. The saw blades should be 190 mm.
 - 15. Pull out battery before carrying out any adjustment, servicing or maintenance.
 - 16. Be careful of brake kickback.
This circular saw features an electric brake that functions when the switch is released. As there is some kickback when the brake functions, be sure to hold the main body securely.
 - 17. Ensure that the switch is in the OFF position. If the battery installed to power tool while the switch is in the ON position, the power tool will start operating immediately, which could cause a serious accident.
 - 18. Avoid cutting in the state where the base has floated up from the material.
When blade is binding, or when interrupting a cut for any reason, release the trigger and hold the saw motionless in the material until the blade comes to a complete stop. Never attempt to remove the saw from the work or pull the saw backward while the blade is in motion or KICKBACK may occur. Investigate and take corrective actions to eliminate the cause of blade binding.
 - 19. Support large panels to minimize the risk of blade pinching and KICKBACK. Large panels tend to sag under their own weight (Fig. 3). Supports must be placed under the panel on both sides, near the line of cut and near the edge of the panel as shown in Fig. 2. To minimize the risk of blade pinching and kickback. When cutting operation requires the resting of the saw on the work piece, the saw shall be rested on the larger portion and the smaller piece cut off.
 - 20. Use extra caution when making a “Pocket Cut” into existing walls or other blind areas. The protruding blade may cut objects that can cause KICKBACK. NEVER place your hand or fingers behind the saw (Fig. 4). If kickback occurs, the saw could easily jump backwards over your hand, possibly causing severe injury.
 - 21. **WARNING :** It is important to support the work piece properly and to hold the saw firmly to prevent loss of control which could cause personal injury. Fig. 5 illustrates typical hand support of the saw.
 - 22. Place the wider portion of the saw base on that part of the work piece which is solidly supported, not on the section that will fall off when the cut is made. As examples, Fig. 6 illustrates the RIGHT way to cut off the end of board, and Fig. 7 the WRONG way. If the work piece is short or small, clamp it down. DON'T TRY TO HOLD SHORT PLACES BY HAND!
 - 23. Never attempt to saw with the circular saw held upside down in a vise.
This is extremely dangerous and can lead to serious accidents. (Fig. 8)
 - 24. When using the guide, do not attempt an inclined cut which would allow the cut material to slip between the saw blade and guide. Doing so could result in injury. (Fig. 9)
 - 25. Should lever remain loosened, it will create a very hazardous situation. Always thoroughly clamp it. (Fig. 12)
 - 26. It is very hazardous to allow the incline lever to remain loosened. Always thoroughly clamp it. (Fig. 13)
 - 27. Prior to cutting operation, make sure the material you are going to cut. If the material to be cut is expected to generate harmful / toxic dusts, make sure the dust bag or appropriate dust extraction system is connected with dust outlet tightly.
Wear the dust mask additionally, if available.
- Before starting to saw, confirm that the saw blade has attained full-speed revolution.
 - Should the saw blade stop or make an abnormal noise while operating, promptly turn OFF the switch.
 - Using the circular saw with the saw blade facing upwards or sideways is very hazardous. Such uncommon applications should be avoided.

- When cutting materials, always wear protective glasses.
- When finished with a job, pull out the battery.
- 28. After having attached the saw blade, reconfirm that the lock lever is firmly secured in the prescribed position.
- 29. Do not use the tool with only the blower function. (Fig. 22)
- 30. Use a saw blade that is for cutting wood.
- 31. Use a saw blade with a displayed speed that is equal to or higher than the rotation speed displayed on the tool.
- 32. Use a saw blade that complies with EN847-1.
- 33. Do not expose directly your eye to the light by looking into the light.
If your eye is continuously exposed to the light, your eye will be hurt.
Wipe off any dirt or grime attached to the lens of the LED light with a soft cloth, being careful not to scratch the lens.
Scratches on the lens of the LED light can result in decreased brightness.
- 34. Do not give a strong shock to the switch panel or break it. It may lead to a trouble.
- 35. Always charge the battery at a temperature of 0°C–40°C. A temperature of less than 0°C will result in over charging which is dangerous. The battery cannot be charged at a temperature higher than 40°C. The most suitable temperature for charging is that of 20°C–25°C.
- 36. Do not use the charger continuously.
When one charging is completed, leave the charger for about 15 minutes before the next charging of battery.
- 37. Do not allow foreign matter to enter the hole for connecting the rechargeable battery.
- 38. Never disassemble the rechargeable battery and charger.
- 39. Never short-circuit the rechargeable battery. Short-circuiting the battery will cause a great electric current and overheat. It results in burn or damage to the battery.
- 40. Do not dispose of the battery in fire. If the battery is burnt, it may explode.
- 41. Bring the battery to the shop from which it was purchased as soon as the post-charging battery life becomes too short for practical use. Do not dispose of the exhausted battery.
- 42. Do not insert objects into the air ventilation slots of the charger.
Inserting metal objects or inflammables into the charger air ventilation slots will result in electrical shock hazard or a damaged charger.
- 43. When using this unit continuously, the unit may overheat, leading to damage in the motor and switch. Therefore, whenever the housing becomes hot, give the tool a break for a while.
- 44. Make sure that the battery is installed firmly. If it is at all loose it could come off and cause an accident.
- 45. Do not use the product if the tool or the battery terminals (battery mount) are deformed.
Installing the battery could cause a short circuit that could result in smoke emission or ignition.
- 46. Keep the tool's terminals (battery mount) free of swarf and dust.
○ Prior to use, make sure that swarf and dust have not collected in the area of the terminals.
○ During use, try to avoid swarf or dust on the tool from falling on the battery.
○ When suspending operation or after use, do not leave the tool in an area where it may be exposed to falling swarf or dust.
Doing so could cause a short circuit that could result in smoke emission or ignition.
- 47. Always use the tool and battery at temperatures between -5°C and 40°C.

CAUTION ON LITHIUM-ION BATTERY

To extend the lifetime, the lithium-ion battery equips with the protection function to stop the output.

In the cases of 1 to 3 described below, when using this product, even if you are pulling the switch, the motor may stop. This is not the trouble but the result of protection function.

1. When the battery power remaining runs out, the motor stops.
In such a case, charge it up immediately.
2. If the tool is overloaded, the motor may stop. In this case, release the switch of tool and eliminate causes of overloading. After that, you can use it again.
3. If the battery is overheated under overload work, the battery power may stop.
In this case, stop using the battery and let the battery cool. After that, you can use it again.

Furthermore, please heed the following warning and caution.

WARNING

In order to prevent any battery leakage, heat generation, smoke emission, explosion and ignition beforehand, please be sure to heed the following precautions.

1. Make sure that swarf and dust do not collect on the battery.
○ During work make sure that swarf and dust do not fall on the battery.
- Make sure that any swarf and dust falling on the power tool during work do not collect on the battery.
- Do not store an unused battery in a location exposed to swarf and dust.
- Before storing a battery, remove any swarf and dust that may adhere to it and do not store it together with metal parts (screws, nails, etc.).
2. Do not pierce battery with a sharp object such as a nail, strike with a hammer, step on, throw or subject the battery to severe physical shock.
3. Do not use an apparently damaged or deformed battery.
4. Do not use the battery for a purpose other than those specified.
5. If the battery charging fails to complete even when a specified recharging time has elapsed, immediately stop further recharging.
6. Do not put or subject the battery to high temperatures or high pressure such as into a microwave oven, dryer, or high pressure container.
7. Keep away from fire immediately when leakage or foul odor are detected.
8. Do not use in a location where strong static electricity generates.
9. If there is battery leakage, foul odor, heat generated, discolored or deformed, or in any way appears abnormal during use, recharging or storage, immediately remove it from the equipment or battery charger, and stop use.
10. Do not immerse the battery or allow any fluids to flow inside. Conductive liquid ingress, such as water, can cause damage resulting in fire or explosion. Store your battery in a cool, dry place, away from combustible and flammable items. Corrosive gas atmospheres must be avoided.
11. Do not give a strong shock to the display panel or break it. It may lead to a trouble.

CAUTION

1. If liquid leaking from the battery gets into your eyes, do not rub your eyes and wash them well with fresh clean water such as tap water and contact a doctor immediately.
If left untreated, the liquid may cause eye-problems.

English

2. If liquid leaks onto your skin or clothes, wash well with clean water such as tap water immediately.
There is a possibility that this can cause skin irritation.
3. If you find rust, foul odor, overheating, discolor, deformation, and/or other irregularities when using the battery for the first time, do not use and return it to your supplier or vendor.

WARNING

If a conductive foreign matter enters in the terminal of lithium ion battery, the battery may be shorted, causing fire. When storing the lithium ion battery, obey surely the rules of following contents.

- Do not place conductive debris, nail and wires such as iron wire and copper wire in the storage case.
- To prevent shorting from occurring, load the battery in the tool or insert securely the battery cover for storing until the ventilator is not seen.

REGARDING LITHIUM-ION BATTERY TRANSPORTATION

When transporting a lithium-ion battery, please observe the following precautions.

WARNING

Notify the transporting company that a package contains a lithium-ion battery, inform the company of its power output and follow the instructions of the transportation company when arranging transport.

- Lithium-ion batteries that exceed a power output of 100 Wh are considered to be in the freight classification of Dangerous Goods and will require special application procedures.
- For transportation abroad, you must comply with international law and the rules and regulations of the destination country.

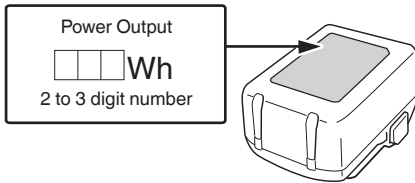

NAMES OF PARTS

The numbers in the list below correspond to **Fig. 1–Fig. 25**.

1	Switch
2	Switch lock
3	Saw cover
4	Lower guard lever
5	M7 bolt
6	Washer (B)
7	Saw blade
8	Lower guard
9	Base
10	Incline lever
11	Inclined gauge
12	Handle









13	Hook
14	Sub handle
15	Lock lever
16	LED light
17	5 mm Hex. bar wrench
18	Battery
19	Charge indicator lamp
20	Square
21	Hex. socket set screw
22	3 mm Hex. bar wrench
23	Lever
24	Premarked line
25	Front scale at 45° incline
26	Front scale when not inclined
27	Mode selector switch
28	Mode Indicator lamp
29	Dust collector
30	M4 Screw
31	Guide fastener wing-bolt
32	Lock spring
33	Guide
34	Latch
35	Washer (A)
36	Concave side
37	Battery level indicator switch
38	Battery level indicator lamp
39	Display panel

SYMBOLS







WARNING

The following show symbols used for the machine. Be sure that you understand their meaning before use.

	C3607DB: Cordless Circular Saw
	To reduce the risk of injury, user must read instruction manual.
	Always wear eye protection.
	Always wear hearing protection.

	Rated voltage
n_0	No-load speed
	Switching ON
	Switching OFF
	Disconnect the battery
	Prohibited action
	High Torque mode is selected
	Auto Switch mode is selected
	Blower
	Warning

Battery

	Lights ; The battery remaining power is over 75%.
	Lights ; The battery remaining power is 50%–75%.
	Lights ; The battery remaining power is 25%–50%.
	Lights ; The battery remaining power is less than 25%.
	Blinks ; The battery remaining power is nearly empty. Recharge the battery soonest possible.
	Blinks ; Output suspended due to high temperature. Remove the battery from the tool and allow it to fully cool down.
	Blinks ; Output suspended due to failure or malfunction. The problem may be the battery so please contact your dealer.

NOTE

To prevent the battery power consumption caused by forgetting to turn off the LED light, the light goes off automatically in about 3 seconds.

STANDARD ACCESSORIES

In addition to the main unit (1 unit), the package contains the accessories listed on page 29.

Standard accessories are subject to change without notice.

APPLICATIONS

Cutting various types of wood.

SPECIFICATIONS

1. Power tool

Model		C3607DB	
Voltage		DC 36 V	
No-load speed		6000 /min (Auto Switch mode) 4500 /min (High Torque mode)	
Blade external dia.		190 mm	
Blade hole dia.		25.4 mm	
Capacity	Cutting depth	90°	64.5 mm
		45°	49 mm
Battery available for this tool*1		Multi volt battery / AC/DC Adapter (sold separately)	
Weight*2		4.3 kg (BSL36A18X) 4.6 kg (BSL36B18X)	

*1 Existing batteries (BSL3660/3620/3626, BSL18 series, etc.) cannot be used with this tool.

If using the AC/DC Adapter, please read and understand its manual before operating the power tool.

*2 Weight is without the saw blade.

NOTE

Due to HiKOKI's continuing program of research and development, the specifications herein are subject to change without prior notice.

Electronic control

- Soft-start
- Brake function
Battery; Small counter-force
AC/DC Adapter; Large counter-force
 - Please be aware that the counter-force of the brake differs depending on the battery being used.
- Overload protection
This protection feature cuts off the power to the motor in the event of overloading of motor or a conspicuous reduction in rotational speed during operation. When the overload protection feature has been activated, the motor may stop. In this case, release the tool switch and eliminate causes of overloading. After that you can use it again.
- Overheat protection
This protection feature cuts off the power to the motor and stops the power tool in the event of overheating of motor during operation. When the overheat protection feature has been activated, the motor may stop. In this case, release the tool switch and cool it down in a few minutes. After that you can use it again.
- Rotation speed changeover function (Auto Switch mode / High Torque mode)
- Precaution for continuous cutting
When using AC/DC Adapter if the switch is repeatedly switched ON and OFF during a short period of time

English

while in the Auto Switch mode, the tool will be stopped early by the overheat protection feature. When that happens, using the High Torque mode is recommended.

2. Battery

Model	Voltage	Battery capacity
BSL36A18X	36 / 18 V*1	2.5 / 5.0 Ah*1

*1 The tool itself will automatically switch over.

CHARGING

Before using the power tool, charge the battery as follows.

<UC18YSL3>

1. Connect the charger's power cord to the receptacle.

When connecting the plug of the charger to a receptacle, the charge indicator lamp will blink in red. (See **Table 1**)

2. Insert the battery into the charger.

Firmly insert the battery into the charger as shown in **Fig. 10** (on page 3).

3. Charging







When inserting a battery in the charger, charging will commence and the charge indicator lamp will blink in blue.

When the battery becomes fully recharged, the charge indicator lamp will light up in green. (See **Table 1**)

(1) Charge indicator lamp indication

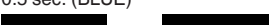
The indications of the charge indicator lamp will be as shown in **Table 1**, according to the condition of the charger or the rechargeable battery.

Table 1: Indications of the charge indicator lamp

ON/OFF at 0.5 sec. intervals (RED) 	Before charging *1
Lights for 0.5 sec. at intervals of 1 sec. (BLUE) 	Charged at less than 50%
Lights for 1 sec. at intervals of 0.5 sec. (BLUE) 	Charged at less than 80%
Lights continuously (BLUE) 	Charged at more than 80%
Lights continuously (Continuous buzzer sound: about 6 sec.) (GREEN) 	Charging complete
ON/OFF at 0.3 sec. intervals (RED) 	Overheat standby *2
ON/OFF at 0.1 sec. intervals (Intermittent buzzer sound: about 2 sec.) (PURPLE) 	Charging impossible *3

NOTE

*1 If the red lamp continues to blink even after the charger has been attached, check to confirm that the battery has been fully inserted.

*2 Battery overheated. Unable to charge.

Although charging will start once the battery has cooled down even when left in situ, the best practice is to remove the battery and allow it to cool down in a shaded, well-ventilated location before charging.

*3 Malfunction in the battery or the charger

– Fully insert the battery.

– Check to confirm that no foreign matter is stuck to the battery mount or terminals. If there are no foreign objects, it is probable that the battery or charger is malfunctioning. Take it to your authorized Service Center.

○ When the battery charger has been continuously used, the battery charger will be heated, thus constituting the cause of the failures. Once the charging has been completed, give 5 minutes rest until the next charging.

(2) Regarding the temperatures and charging time of the battery (See **Table 2**)

Table 2

Model	UC18YSL3	
Type of battery	Li-ion	
Charging voltage	14.4–18 V	
Temperatures at which the battery can be recharged	0°C–50°C	
Charging time for battery capacity, approx. (At 20°C)	1.5 Ah	15 min
	2.0 Ah	20 min
	2.5 Ah	25 min
	3.0 Ah	20 min (BSL1430C, BSL1830C: 30 min)
	4.0 Ah	26 min (BSL1840M: 40 min)
	5.0 Ah	32 min
Charging time for multi volt battery capacity, approx. (At 20°C)	6.0 Ah	38 min
	1.5 Ah (x 2 unit)	20 min
	2.5 Ah (x 2 unit)	32 min
	4.0 Ah (x 2 unit)	52 min
Number of battery cells	4–10	
Weight	0.6 kg	

NOTE

○ The recharging time may vary according to the ambient temperature and power source voltage.

○ If charging takes a long time

– Charging will take longer at extremely low ambient temperatures. Charge the battery in a warm location (such as indoors).

– Do not block the air vent. Otherwise the interior will overheat, reducing the charger's performance.

– If the cooling fan is not operating, contact a HiKOKI Authorized Service Center for repairs.

- 4. Disconnect the charger's power cord from the receptacle.
- 5. Hold the charger firmly and pull out the battery.

NOTE

Be sure to pull out the battery from the charger after use, and then keep it.

Regarding electric discharge in case of new batteries, etc.

As the internal chemical substance of new batteries and batteries that have not been used for an extended period is not activated, the electric discharge might be low when using them the first and second time. This is a temporary phenomenon, and normal time required for recharging will be restored by recharging the batteries 2–3 times.

How to make the batteries perform longer.

- (1) Recharge the batteries before they become completely exhausted. When you feel that the power of the tool becomes weaker, stop using the tool and recharge its battery. If you continue to use the tool and exhaust the electric current, the battery may be damaged and its life will become shorter.
- (2) Avoid recharging at high temperatures. A rechargeable battery will be hot immediately after use. If such a battery is recharged immediately after use, its internal chemical substance will deteriorate, and the battery life will be shortened. Leave the battery and recharge it after it has cooled for a while.

Action	Figure	Page
Selecting accessories	—	30

- *1 How to use the LED light
This product features LED interlock function that means the LED will turn ON / OFF automatically depending on the product's power ON / OFF.
- *2 About the mode select function
Each time the mode selector switch is pushed, the operation mode changes.
When the High Torque mode is selected, the mode selector lamp lights up.
The High Torque mode reduces maximum motor RPM enabling efficient work.
If the load increases while the motor is operating in the Auto Switch mode, it automatically changes to the High Torque mode.
Additionally, if the load decreases again, it automatically returns to the Auto Switch mode.
In the High Torque mode, it does not change to the Auto Switch mode even when the load decreases.

Mode	No-load speed
Auto Switch	6000 /min
High Torque	4500 /min

NOTE

- The mode will only change after a battery is installed and the switch is pulled once.
- The current mode will be maintained even if the switch is on/off, or the battery is removed/reinserted.
- *3 How to use the hook
The hook can be used to hang up the unit temporarily during operations.



CAUTION

- When using the hook, check to make sure that the main unit will not slip and fall, or become unstable by the wind, etc.
- Never hang the unit from your belt or trousers as this could cause accidents.

LED LIGHT WARNING SIGNALS

This product features functions that are designed to protect the tool itself as well as the battery. If any of the safeguard functions are triggered during operation, the LED light will blink as described in **Table 3**.
When any of the safeguard functions are triggered, immediately remove your finger from the switch and follow the instructions described under corrective action.

Table 3

LED Light Display	Safeguard Function
On 0.1 second/off 0.1 second 	Overburden Protection Remove the cause of the overloading.
On 0.5 second/ Off 0.5 second 	Temperature protection Allow the tool and battery to thoroughly cool.

MOUNTING AND OPERATION

Action	Figure	Page
Inclined cutting using the guide (+45° direction)	9	3
Charging	10	3
Adjusting the base and saw blade to maintain perpendicularity	11	3
Adjusting the cutting depth	12	4
Adjusting the angle of inclination	13	4
Cutting line	14	4
Switch operation	15	4
How to use the LED light*1	16	5
About the mode select function*2	17	5
Mounting the dust collector set (sold separately)	18	5
How to use the hook*3	19	5
Attaching the guide	20	5
Removing and inserting the battery	21	6
Cutting (Do not use the tool with only the blower function.)	22	6
Dismounting the saw blade	23	6
Mounting the saw blade	24	7
Remaining battery indicator	25	7

MAINTENANCE AND INSPECTION

1. Inspecting the saw blade

Since use of a dull saw blade will degrade efficiency and cause possible motor malfunction, sharpen or replace the saw blade as soon as abrasion is noted.

2. Inspecting the mounting screws

Regularly inspect all mounting screws and ensure that they are properly tightened. Should any of the screws be loose, retighten them immediately. Failure to do so could result in serious hazard.

3. Motor unit maintenance

The motor winding is an important part of this tool. Avoid damaging and be careful to avoid contact with cleaning oil or water.

After 50 hours of use, clean the motor by blowing into the ventilation holes of the motor housing with dry air from an air gun or other tool (**Fig. 26**).

Dust or particle accumulation in the motor can result in damage.

4. Inspecting and maintaining the lower guard

Always make sure that the lower guard moves smoothly.

In the event of any malfunction, immediately repair the lower guard.

For cleaning and maintenance, use an air gun or other tool to blow clean the space between the lower guard and gear cover as well as the rotation part of the lower guard with dry air (**Fig. 26**).

Doing so is effective for the emission of chips or other particles.

Accumulation of chips or other particles around the lower guard may result in malfunction or damage.

WARNING

To prevent dust inhalation or eye irritation, wear protective safety goggles and a dust mask when using an air gun or other tool to clean the lower guard, ventilation holes or other parts of the product.

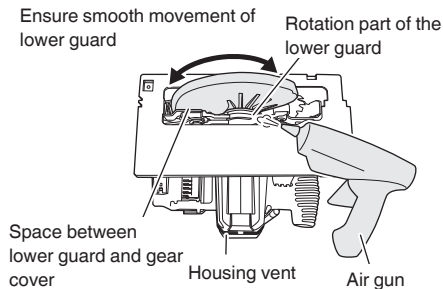

Fig. 26

5. Cleaning the inside of the saw cover

Regularly check and clean to make sure that sawdust and other residue do not collect inside of the saw cover. Always remove the saw blade when checking and cleaning.

6. Inspection of terminals (tool and battery)

Check to make sure that swarf and dust have not collected on the terminals.

On occasion check prior, during and after operation.

CAUTION

Remove any swarf or dust which may have collected on the terminals.

Failure to do so may result in malfunction.

7. Cleaning on the outside

When the power tool is stained, wipe with a soft dry cloth or a cloth moistened with soapy water. Do not use chloric solvents, gasoline or paint thinner, for they melt plastics.

8. Storage

Store the power tool and battery in a place in which the temperature is less than 40°C and out of reach of children.

NOTE

Storing lithium-ion batteries.

Make sure the lithium-ion batteries have been fully charged before storing them.

Prolonged storage (3 months or more) of batteries with a low charge may result in performance deterioration, significantly reducing battery usage time or rendering the batteries incapable of holding a charge.

However, significantly reduced battery usage time may be recovered by repeatedly charging and using the batteries two to five times.

If the battery usage time is extremely short despite repeated charging and use, consider the batteries dead and purchase new batteries.

CAUTION

In the operation and maintenance of power tools, the safety regulations and standards prescribed in each country must be observed.

Important notice on the batteries for the HiKOKI cordless power tools

Please always use one of our designated genuine batteries. We cannot guarantee the safety and performance of our cordless power tool when used with batteries other than these designated by us, or when the battery is disassembled and modified (such as disassembly and replacement of cells or other internal parts).

NOTE

Due to HiKOKI's continuing program of research and development, the specifications herein are subject to change without prior notice.

TROUBLESHOOTING

Use the inspections in the table below if the tool does not operate normally. If this does not remedy the problem, consult your dealer or the HiKOKI Authorized Service Center.

Symptom	Possible cause	Remedy
Tool doesn't run	No remaining battery power	Charge the battery.
	The trigger switch was held down while the battery was inserted.	The safety function was activated. If the trigger switch is released once and then pulled again, the tool will run.
	Battery isn't fully installed.	Push the battery in until you hear a click.
Tool suddenly stopped	Tool was overburdened	Get rid of the problem causing the overburden.
	Overload protection is in operation.	
	The battery is overheated.	Let the battery cool down.
	The trigger switch was held down for 5 minutes or more.	This is not a malfunction. The motor was automatically stopped to prevent failure of the tool.
Cannot be inclined	The incline lever is not loosened.	Try inclining after loosening the incline lever. Tighten the incline lever after making the necessary adjustments.
Doesn't cut well	The saw blade is worn or missing teeth.	Replace with a new saw blade.
	The bolt is loose.	Firmly tighten the bolt.
	The saw blade is installed backwards.	Install the saw blade in the proper direction.
Switch can't be pulled	The switch lock is not pushed in enough.	Push the switch lock in all the way.
Sawdust discharge is poor	Sawdust has accumulated in the saw cover.	Remove the sawdust inside the saw cover.
Battery cannot be installed.	Attempting to install a battery other than that specified for the tool.	Please install a multi volt type battery.

一般安全規則

警告

閱讀所有安全警告說明

未遵守警告與說明可能導致電擊、火災或其他嚴重傷害。

請妥善保存本使用說明書，以供未來參考之用。

「電動工具」一詞在警告中，係指電源操作（有線）之電動工具或電池操作（無線）之電動工具。

1) 工作場所安全

- a) 保持工作場所清潔及明亮。
雜亂或昏暗的區域容易發生意外。
- b) 勿在易產生爆炸之環境中操作，譬如有易燃液體、瓦斯或粉塵存在之處。
電動工具產生火花會引燃粉塵或煙氣。
- c) 當操作電動工具時，確保兒童及過往人員遠離。
分神會讓您失去控制。

2) 電氣安全

- a) 電動工具插頭必須與插座配合，絕不可以任何方法修改插頭，且不得使用任何轉接插頭於有接地之電動工具。
不修改插頭及所結合之插座，可減少電擊。
- b) 避免身體接觸到地面，諸如管子、散熱器、爐灶及冰箱。
如果您的身體接地或觸地，會增加電擊的危險。
- c) 勿讓電動工具淋雨或曝露在潮濕的環境下。
電動工具進水會增加電擊的危險。
- d) 勿濫用電源線。請勿使用電源線去纏繞、拖拉電動工具或拔插頭，保持電源線遠離熱氣、油氣、尖角或可動零件。
損壞或纏繞的電源線會增加電擊之危險。
- e) 電動工具在室外操作時，請務必使用適合室外用的延長線。
使用合適之室外用延長線會減少電擊的危險。
- f) 若無法避免在潮濕地區操作電動工具，請使用以漏電斷路器 (RCD) 來保護電源。
使用 RCD，可降低觸電危險。

3) 人員安全

- a) 保持機警，注意您正在做什麼，並運用正確常識操作電動工具。當你感到疲勞或受藥品、酒精或醫療影響時，請勿操作電動工具。
操作中瞬間的不注意，可能造成人員嚴重的傷害。
- b) 使用個人防護裝備，經常配戴安全眼鏡。

配戴防塵口罩、防滑安全鞋、硬帽等防護裝備，或在適當情況下使用聽覺防護，可減少人員傷害。

- c) 防止意外發生。在連接電源或電池組、拿起或攜帶工具前，請確認開關是在「off」（關閉）的位置。
以手指放在開關握持電動工具，或在電動工具的開關於「on」的狀況下插上插頭，都會導致意外發生。
 - d) 在電動工具啟動前，先卸下任何調整用鑰匙或扳手。
扳手或鑰匙遺留在電動工具的轉動部位時，可能導致人員傷害。
 - e) 身體勿過度伸張，任何時間要保持站穩及平衡。
以便在不預期的狀態下，能對電動工具有較好的控制。
 - f) 衣著要合宜，別穿太鬆的衣服或戴首飾。保持你的頭髮、衣服及手套遠離轉動部位。
寬鬆的衣服、手飾及長髮會被捲入轉動部位。
 - g) 如果裝置要用於粉塵抽取及集塵設施，要確保其連接及正當使用。
使用集塵裝置可減少與灰塵相關的危險。
 - h) 請勿因頻繁使用本工具，熟悉操作而忽略本工具的安全原則。
粗心的行動有可能瞬間即造成嚴重傷害。
- ### 4) 電動工具之使用及注意事項
- a) 勿強力使用電動工具，使用正確之電動工具為您所需。
正確使用電動工具，會依其設計條件，使工作做得更好更安全。
 - b) 如果開關不能轉至開或關的位置，勿使用電動工具。
任何電動工具不能被開關所控制是危險的，必須要修理。
 - c) 進行任何調整、更換配件或收存電動工具時，必須將插頭與電源分開，且需將電池組從電動工具中取出。
此種預防安全措施，可減少意外開啟電動工具之危險。
 - d) 收存停用之電動工具，需遠離兒童，且不容許不熟悉電動工具或未瞭解操作電動工具說明的人操作電動工具。
在未受過訓練的人手裡，電動工具極為危險。
 - e) 保養電動工具，檢查是否可動零件有錯誤的結合或卡住、零件破裂及可能影響電動工具操作的任何其他情形。電動工具如果損壞，在使用前要修好。
許多意外皆肇因於不良的保養。
 - f) 保持切割工具銳利清潔。

適當的保養切割工具，保持銳利之切削鋒口，可減少卡住並容易控制。

- g) 按照說明書使用電動工具、配件及刀具時，必須考量工作條件及所執行之工作。
若未依照這些使用說明操作電動工具時，可能造成相關之危害情況。
- h) 保持把手和握持面乾燥、清潔，且未沾到油脂和潤滑油。
滑溜的把手和握持面在操作時會有安全上的問題，且可能造成本工具意外失去控制。
- 5) 電池式電動工具的使用及注意事項
- a) 需再充電時，僅能使用製造商指定的充電器。
因充電器僅適合同一型式的電池組，若使用任何其它電池組時，將導致起火的危險。
- b) 使用電動工具時，僅能使用按照其特性設計的電池組。
因使用其它任何電池組時，將導致人員傷害及起火的危險。
- c) 當電池組不再使用時，需保存好並遠離其它的金屬物件，例如：迴紋針、錢幣、鑰匙、圖釘、螺釘，或類似能造成端子與端子間連接的其它較小金屬物件。
因電池組端子間短路時，將導致燃燒或起火的危險。
- d) 在誤用情況下，電解液可能自電池中噴出；請避免接觸。當發生意外接觸時，請用清水沖洗。若電解液觸及眼睛時，請儘速尋求醫療協助。
因自電池中噴出的電解液，將導致灼傷或刺激皮膚。
- e) 請勿使用損壞或改造的電池組或電動工具。
損壞或改造的電池可能會發生不可預知的行為，進而導致火災、爆炸或受傷的風險。
- f) 請勿使電池組或電動工具接觸到火源或處於溫度過高的地方。
接觸火源或溫度超過130°C可能會引起爆炸。
- g) 請遵循所有充電指示，並且不要在說明書指定的溫度範圍之外為電池組或電動工具充電。
充電不當或溫度超出指定範圍可能會損壞電池並增加火災的風險。
- 6) 維修
- a) 讓您的電動工具由合格修理人員僅使用相同的維修零件更換。
如此可確保電動工具的安全得以維持。
- b) 切勿對損壞的電池組進行維修。
電池組的維修只能由製造商或授權服務維修店進行。

注意事項

不可讓孩童和體弱人士靠近工作場所。
應將不使用的電動工具存放在孩童和體弱人士伸手不及的地方。

手提電動圓鋸之安全說明

鋸切步驟

- a) △ 危險：手部必須遠離鋸片與切割區域。另一手須握持輔助把手或馬達外殼。
如果雙手皆握住圓鋸機，雙手便可免於鋸片所傷。
- b) 不可碰觸下方的工件。
否則保護罩無法保護您免於鋸片所傷。
- c) 調整工件厚度的相對鋸切深度。
在工件下方應可看到小於鋸片全齒深之深度。
- d) 鋸切時，切勿用手握持工件或用腿橫跨工件。必須將工件固定於平穩的工作台。
減少身體的暴露、鋸片卡住或失控，是正確的完成工作的重要憑藉。
- e) 在鋸切工具可能接觸到隱藏線路或其本身的電線之情況下進行操作時，請握住本工具的絕緣握持面。
接觸到「通電」的電線將使電動工具的金屬零件「通電」，而造成操作人員觸電。
- f) 進行鋸切時應使用鋸切護罩或引導器。
此舉可改善鋸切的精確度並減少發生鋸片卡住的機會。
- g) 使用正確的軸孔尺寸與形狀(菱形端或圓端)的鋸片。
若鋸片與鋸機的安裝硬體不相配，鋸片在運作時會偏離中心，並導致失控。
- h) 不可使用已損壞或不正確的鋸片墊圈或螺栓。
鋸片墊圈與螺栓是特別專為圓鋸機所設計以提供最佳的性能表現與最安全的操作。

反衝原因和相關警告

- 反衝是因鋸片被夾住、卡住或未對準，而導致鋸機失控抬起或脫離工件，並朝向操作人員的作用力；
- 當鋸片被切口緊緊地夾住或卡住時，會造成鋸片動彈不得，電動機失衡之下會帶動本工具迅速反撲向操作人員；
- 鋸切時鋸片扭曲或不正，鋸片後緣的齒部便會戳入木材的上表面而造成鋸片脫離切口並回彈朝向操作員。

反衝作用是圓鋸機誤用或操作程序或條件不正確所造成的結果，以下所列的正確防範措施可以避免此類問題的發生。

中國語

- a) 兩手保持緊握圓鋸機並且將手臂置於適當的位置以抵抗反衝作用力。身體須位於鋸片的任一側，身體與鋸片不可成一直線。
反衝作用力會導致圓鋸向後彈跳，但如果採取適當的預防措施，反衝作用力是可以被操作者所控制。
- b) 當鋸片被夾住時或者由於某些原因中斷時，請鬆開開關機並且保持圓鋸機不動，直到鋸片作動完全停止。
當鋸片在運行中或者有可能發生反衝作用力時，決不可試圖從工件上移開圓鋸機或者將圓鋸機向後拉。
須進行調查並且採取矯正措施以消除鋸片夾住的原因。
- c) 重新啟動鋸切工件時，須將鋸片定位在切口中央，不要使鋸齒與材料啣合。
如果鋸片有夾入，重新啟動鋸機時，鋸機可能會從工件向上移動或產生反衝。
- d) 採用大面板支撐座，使鋸片受夾住或產生反衝作用力的風險降到最低。
由於其自身重力，大面板支撐座趨於下陷。
支撐座必須置於面板兩側的下方，靠近鋸切路徑與面板邊緣。
- e) 不要使用不鋒利或已損壞的鋸片。
裝設不鋒利或不正確的鋸片會產生狹窄切口而造成過大的磨擦力、鋸片夾住以致產生反衝作用力。
- f) 在進行鋸切之前，必須牢牢地固定住鋸片深度與斜度調整鎖定桿。
如果鋸片調整裝置在鋸切時移動，可能會造成夾住並產生反衝作用力。
- g) 在進行牆壁或其他隱蔽區域之鋸切時，請格外小心。
鋸片可能會鋸切到足以產生反衝作用力的物體。

下罩功能

- a) 在每次使用之前，先檢查下罩是否能正確的關閉。如果下罩無法自由移動與立即關閉，決不可操作鋸機。切勿將下罩夾入或拴入開啟位置。
如果圓鋸機不慎掉落，下罩可能會彎折。
使用縮回把手以升起下罩，並確定其可自由移動，而且在各種角度和深度之鋸切皆不會接觸到鋸片或者任何其他部位。
- b) 檢查下罩彈簧之作動狀況。如果下罩與彈簧皆無法正確的作動，請在使用之前必須先行將它們修復。
下罩可能由於零件損壞、黏膠沉澱，殘屑生成而造成作動遲滯。
- c) 僅在使用「切入式鋸切」與「複合式鋸切」之類的特殊鋸切方式時，才能使用手動縮回下罩。利用縮回把手可將下罩升起，當鋸片開始切入工件材料時，下罩必須是釋放的狀態。

- d) 所有圓鋸機的下罩皆應可自動的作動。
- d) 在將圓鋸機置於工作台或地板上之前，務必先檢查下罩是否有覆蓋於鋸片上。
一個未受保護、限制的鋸片將會導致圓鋸機反向行進而產生任意鋸切的情形。請務必明瞭在鬆開關閉後至鋸片完全停止時所需的時間。

附加安全警告

1. 操作時佩戴耳塞，保護耳朵。
2. 僅使用本圓鋸機所指定的鋸片直徑。
3. 不可使用任何砂輪。
4. 不要使用變形或斷裂的鋸片。
5. 不要使用由高速鋼所做成的鋸片。
6. 不要使用未依照規定的鋸片。
7. 不要在圓盤上施加橫向壓力使鋸片停止。
8. 隨時保持鋸片鋒利。
9. 確定下罩可平順且自由的移動。
10. 決不可將圓鋸機的下罩固定在開啟位置。
11. 確定護罩系統的縮回機構能正確的作動。
12. 決不以向上或移動至側邊的操作方式進行操作圓鋸機。
13. 確保工件材料沒有鐵釘之類的異物。
14. 鋸片應為190 mm。
15. 在進行任何調整、保養或維修之前，須先取出電池。
16. 小心因制動器的作用而引起的反彈。
本圓鋸機配備有電動制動器，當開關釋放時會起作用。當制動器起作用時會產生一些反彈，請務必牢固地握住主機身。
17. 確保開關處於OFF位置。如果在電源開關處於ON位置時安裝電池，電動工具將立即開始運作，可能會導致嚴重的事故。
18. 避免在底座已從工件材料上浮起的情況下進行鋸切操作。
當鋸片被夾住時或者由於某些原因中斷時，請鬆開開關機並且保持圓鋸機不動，直到鋸片作動完全停止。當鋸片在運行中或者有可能發生反衝作用力時，決不可試圖從工件上移開圓鋸機或者將圓鋸機向後拉。須進行調查並且採取矯正措施以消除鋸片夾住的原因。
19. 採用大面板支撐座，使鋸片受夾住或產生反衝作用力的風險降到最低。由於其自身重力，大面板支撐座趨於下陷（見圖 3）。支撐座必須置於面板兩側的下方，靠近鋸切路徑與面板邊緣，見圖 2。
為了使鋸片受夾住或產生反衝作用力的風險降至最低。鋸切操作需要圓鋸機抵靠在工作上時，應將圓鋸機擱在工作上大塊部分並且鋸切較小的部分。

20. 在進行牆壁或其他隱蔽區域之「槽切」時，請格外小心。鋸片可能會鋸切到足以產生反衝作用力的物體。
決不可將手或手指置於圓鋸機後面（見圖 4）。若發生反衝作用，圓鋸機可能迅速反撲向手部，並且可能導致嚴重傷害。
21. **警告：**必須正確支撐工件並且握緊圓鋸機，以防失控，否則可能導致人員傷害。圖 5 展示用手支撐圓鋸機的典型做法。
22. 將圓鋸機底座較寬的部分置於工件得到牢固支撐的部分上面，而非在鋸切時會掉落的部分上面。例如，圖 6 展示鋸切木板一端的正確做法，圖 7 展示錯誤的做法。若工件短或小，夾住工件。不可試圖用手握住短工件！
23. 決不可試圖將圓鋸機翻轉夾在臺鉗中進行鋸切。此做法極其危險，並且會導致嚴重事故（圖 8）
24. 使用引導器時，不可試圖進行斜切，會導致鋸切材料會在鋸片與引導器之間滑動，並且可能導致人員傷害。（圖 9）
25. 若控制桿沒有鎖緊，會造成非常危險的狀況。請務必將之完全鎖緊。（圖 12）
26. 若控制傾斜控制桿保持鬆脫狀態，會造成非常危險的狀況。請務必將之完全鎖緊。（圖 13）
27. 進行鋸切操作之前，請確認材料是否適當。若鋸切材料時會產生有害 / 有毒粉塵，請務必在粉塵排出口使用集塵袋或接上適當的粉塵收取設備。必要時請戴上防塵面罩。
○ 開始進行鋸切之前，請確定鋸片有全速運轉。
○ 如果在操作過程中發生鋸片停止運作或發出異常噪音時，請立即關閉開關。
○ 將鋸片朝上或朝側面使用圓鋸機是非常危險的，應避免這種不正常的用途。
○ 鋸切材料時，務請戴上護眼鏡。
○ 完成作業時，應取出電池。
28. 裝上鋸片之後，再次確認鎖定桿有被緊固的鎖在適當的位置上。
29. 不要僅使用本工具的鼓風機功能。（圖 22）
30. 使用切割木材用的鋸片。
31. 以顯示速度等於或高於工具上顯示的轉速來使用鋸片。
32. 使用符合 EN847-1 的鋸片。
33. 請勿讓眼睛直視光線。
若眼睛持續接觸到光線，會造成您雙眼的傷害。用軟布擦去附著在 LED 鏡頭上的灰塵或污垢，注意不要刮傷鏡頭。
LED 鏡頭上的刮痕可能會導致亮度下降。
34. 請勿對開關面板施加強烈的衝擊或將其折斷。這可能會引發問題。
35. 務請在 0-40°C 的溫度下進行充電。溫度低於 0°C 將會導致充電過度，極其危險。電池不能在高於 40°C 的溫度下充電。最適合於充電的溫度是 20-25°C。
36. 請勿連續使用充電器。
完成一次充電後，請將充電器擱置大約 15 分鐘，然後再進行下一次充電。
37. 請勿讓異物進入充電電池連接口內。
38. 切勿拆卸充電電池與充電器。
39. 切勿使充電電池短路。電池短路會造成極大電流和過熱。從而燒壞電池。
40. 請勿將電池丟入火中。燃燒電池會引起爆炸。
41. 充電後電池壽命若太短不夠使用，請盡快將電池送往經銷店。不可將用過的電池丟棄。
42. 請勿將異物插入充電器的通風口。
若將金屬異物或易燃物插入通風口的話，將會引起觸電事故或使充電器受損。
43. 連續使用本機時，本機可能出現過熱而導致馬達和開關損壞。因此，每當機殼發熱時，讓工具休息一會兒。
44. 確保電池安裝牢固。如果電池鬆動，可能會脫落而造成事故。
45. 如果工具或電池端子（電池座）變形，請勿使用本產品。
安裝電池可能會造成短路，從而導致冒煙或起火。
46. 保持工具的端子（電池座）沒有削屑和灰塵。
○ 使用前請確認端子區域沒有堆積削屑和灰塵。
○ 使用過程中盡量避免工具上的削屑或灰塵掉落在電池上。
○ 暫停操作或使用後，請勿將工具留在可能暴露於有掉落削屑或灰塵的區域。
否則可能會造成短路，從而導致冒煙或起火。
47. 務必在 -5°C 至 40°C 的溫度下使用本工具和電池。

鋰離子電池使用注意事項

為延長使用壽命，鋰離子電池備配停止輸出的保護功能。

若是在使用本產品時發生下列 1 至 3 的情況，即使按下開關，馬達也可能停止。這並非故障，而是啟動保護功能的結果。

1. 在殘留的電池電力即將耗盡時，馬達會停止。在這種情況下，請立即予以充電。
2. 若工具超過負荷，馬達亦可能停止。在這種情況下，請鬆開工具的開關，試著消除超過負荷的原因。之後您就可以再度使用。
3. 若電池在過載工作情況下過熱，電池電力可能會中止。在這種情況下，請停止使用電池，讓電池冷卻。之後您就可以再度使用。

此外，請留心下列的警告及注意事項。

警告

為事先防止電池發生滲漏、發熱、冒煙、爆炸及起火等事故，請確保留意下列事項。

1. 確保電池上沒有堆積削屑及灰塵。

中國語

- 在工作時確定削屑及灰塵沒有掉落在電池上。
- 確定所有工作時掉落在電動工具上的削屑和灰塵沒有堆積在電池上。
- 請勿將未使用的電池存放在曝露於削屑和灰塵的位置。
- 在存放電池之前，請清除任何可能附著在上面的削屑和灰塵，並請切勿將它與金屬零件（螺絲、釘子等）存放在一起。
- 2. 請勿以釘子等利器刺穿電池、以鐵錘敲打、蹂躪、丟擲電池，或將其劇烈撞擊。
- 3. 切勿使用明顯損壞或變形的電池。
- 4. 請依規定方式使用電池，切勿移作他用。
- 5. 如果已過了再充電時間，電池仍無法完成充電，請立即停止繼續充電。
- 6. 請勿將電池放置於高溫或高壓處，例如微波爐、烘乾機或高壓容器內。
- 7. 發現有滲漏或異味時，請立即將電池遠離火源處。
- 8. 請勿在會產生強烈靜電的地方使用。
- 9. 如電池出現滲漏、異味、發熱、褪色或變形，或在使用、充電或存放時出現任何異常，請立即將它從裝備或電池充電器拆下，並停止使用。
- 10. 請勿將電池浸入任何液體，或讓任何液體流入電池內。若水等具有導性的液體滲入，可能會造成損壞，進而導致火災或爆炸。將電池存放在陰涼、乾燥的地方，遠離可燃及易燃物品。必須避免腐蝕性氣體環境。
- 11. 請勿對顯示面板加強烈的衝擊或將其折斷。這可能會引發問題。

注意

- 1. 若電池滲漏出的液體進入您的眼睛，請勿搓揉眼睛，並以自來水等乾淨清水充分沖洗，立刻送醫。
若不加以處理，液體可能會導致眼睛不適。
- 2. 若液體滲漏至您的皮膚或衣物，請立即以自來水等清水沖洗。
上述情況可能會使皮膚受到刺激。
- 3. 若初次使用電池時發現生鏽、異味、過熱、褪色、變形及/或其他異常情況時，請勿使用並將該電池退還給供應商或廠商。

警告

- 若具有導電性的異物進入鋰離子電池的端子，可能會造成短路，進而引發火災。請在存放電池時遵循以下事項。
- 請勿將導電物品，如鐵釘、鐵絲等金屬絲，銅線和電線放入儲存箱內。
 - 為了防止發生短路，將電池裝入工具內或確實壓下電池蓋儲存電池，直至遮住通風孔為止。

關於鋰離子電池的運輸

運輸鋰離子電池時，請遵守以下注意事項。

警告

- 安排運輸時，請通知運輸公司包裹中含有鋰離子電池，告知該電池之輸出功率，並按照運輸公司的指示。
- 輸出功率超過100 Wh 的鋰離子電池被視為貨物分類中的危險物品，將需要特殊的申請程序。
 - 對於國外的運輸，必須遵守國際法規則和目的國法規。

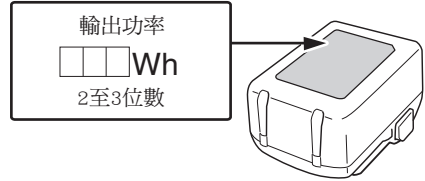

各部位名稱





以下列表中的數字與圖 1 - 圖 25 相對應。

1	開關
2	開關鎖
3	鋸蓋
4	下單控制桿
5	M7 螺栓
6	襯墊 (B)
7	鋸片
8	下單
9	底座
10	傾斜控制桿
11	傾斜量規
12	握把
13	掛鉤
14	副握把
15	鎖定桿
16	LED燈
17	5 mm 六角棒狀扳手
18	電池

19	充電指示燈
20	直角尺
21	六角套筒固定螺絲
22	3 mm 六角棒狀扳手
23	控制桿
24	預先標記的線
25	45度傾斜的前刻度
26	無傾斜的前刻度
27	模式選擇開關
28	模式指示燈
29	集塵器
30	M4 螺絲
31	引導器夾蝶形螺栓
32	鎖簧
33	引導器
34	卡榫
35	襯墊 (A)
36	凹側
37	電池電量指示開關
38	電池電量指示燈
39	顯示屏

	經常配戴安全眼鏡。
	始終佩戴聽力保護裝置。
v	額定電壓
n ₀	無負荷速度
	開關ON
	開關OFF
	取出電池
	禁止操作
	選擇高扭矩模式
	選擇自動切換模式
	鼓風機
	警告



電池

	亮起： 電池剩餘電量超過75%。
	亮起： 電池剩餘電量為50%–75%。
	亮起： 電池剩餘電量為25%–50%。
	亮起： 電池剩餘電量少於25%。
	閃爍： 電池剩餘電量幾近零。請盡快進行充電。
	閃爍： 由於高溫導致輸出被暫停。從工具中取出電池，並使其完全冷卻。

符號

警告

以下為使用於本機器的符號。請確保您在使用前明白其意義。

	C3607DB: 手提電動圓鋸
	使用前請詳讀使用說明書。

中國語



閃爍：
由於故障或機能失常導致輸出被暫停。問題可能是電池，請聯繫您的經銷商。

註

為防止因忘記關閉LED燈而消耗電池的電量，燈光會在約3秒後會自動熄滅。

標準附件

除了主機身(1台)以外，包裝盒內包含第29頁所列之附件。

標準附件可能不預先通告而徑予更改。

用途

鋸切各種木材。

規格

1. 電動工具

機型	C3607DB		
電壓	DC 36 V		
無負荷速度	6000 /min (自動切換模式) 4500 /min (高扭矩模式)		
鋸片外徑	190 mm		
鋸片孔徑	25.4 mm		
容量	鋸切深度	90°	64.5 mm
		45°	49 mm
可用於本工具的電池*1		MV電池/ AC/DC 適配器 (另售)	
重量*2	4.3 kg (BSL36A18X) 4.6 kg (BSL36B18X)		

*1 本工具不能使用現有的電池 (BSL3660/3620/3626、BSL18 系列等)。如果使用 AC/DC 適配器，請在操作本電動工具之前閱讀並理解其說明書。

*2 重量不含鋸片。

註

HiKOKI不斷研究和開發新產品，若規格發生變更，恕不另行通知。

電子控制

- 緩啟動
- 制動功能
電池: 反作用力小
AC/DC 適配器: 反作用力大
 - 請注意，制動器的反作用力因使用的電池而異。
- 過載保護
如果發生馬達過載或在操作過程中轉速顯著降低，本保護功能會切斷馬達的電源。當過載保護功能被啟動時，馬達可能會停止。在這種情況下，請釋放工具開關，並消除過載的原因。
之後您就可以再度使用。
- 過熱保護
如果在操作過程中馬達過熱，本保護功能會切斷馬達的電源並停止電動工具。當過熱保護功能被啟動時，馬達可能會停止。在這種情況下，請釋放工具開關並使其冷卻幾分鐘。
之後您就可以再度使用。
- 轉速切換功能 (自動切換模式 / 高扭矩模式)
- 連續鋸切注意事項
使用 AC/DC 適配器時，如果在自動切換模式下，開關於短時間內反覆開啟和關閉，本工具將因過熱保護功能而提早停止。發生這種情況時，建議使用高扭矩模式。

2. 電池

機型	電壓	電池容量
BSL36A18X	36 / 18 V *1	2.5 / 5.0 Ah *1

*1 工具本身將自動切換。

充電

使用電動工具之前，按下述方法將電池進行充電。

<UC18YSL3>

1. 將充電器的電源線纜連接到插座。
當充電器的插頭連接到插座時，充電信號燈會閃爍紅燈。(見表 1)
2. 將電池裝入充電器。
將電池牢固地裝入充電器，如圖 10所示 (第3頁)。
3. 充電
將電池插入充電器後，就會開始充電，且充電指示燈會閃爍藍燈。

中國語

使用新電池或其他電池，產生電量較弱的問題時

由於新電池及長時間未使用之電池的內部化學物質未活化，因此初次及第二次使用時的電量會較弱。此為暫時現象；在充電 2 至 3 次後，電量 就會恢復正常。

怎樣讓電池使用時間更長

- (1) 在電池電量完全耗盡之前給電池充電。在感覺工具的動力變弱時，停止使用工具並為電池充電。如果繼續使用工具消耗電流，可能會造成對電池的損壞，電池使用壽命會縮短。
- (2) 避免在高溫下充電。電池在剛使用後會發熱。如果在電池剛使用後為電池充電，電池的內部化學物質的性能會下降，電池使用壽命會縮短。請先將電池放置一會兒，待電池冷卻後再進行充電。

安裝和操作

動作	圖表	頁數
使用引導器 (+45° 方向) 傾斜鋸切	9	3
充電	10	3
調整底座和鋸片以保持垂直度	11	3
調整鋸切深度	12	4
調整傾斜角度	13	4
鋸切線	14	4
開關操作	15	4
使用LED燈*1	16	5
關於模式選擇功能*2	17	5
安裝集塵器組 (另售)	18	5
如何使用掛鉤*3	19	5
連接引導器	20	5
拆卸和安裝電池	21	6
切割 (不要僅使用本工具的鼓風機功能。)	22	6
拆下鋸片	23	6
安裝鋸片	24	7
電池剩餘量指示燈	25	7

動作	圖表	頁數
選擇附件	—	30

- *1 使用LED燈
本產品具有 LED 互鎖功能，這意味著 LED 將根據產品的電源開或關而自動開啟或關閉。
- *2 關於模式選擇功能
每次按下模式選擇器開關，將改變操作模式。選擇高扭矩模式時，模式選擇器燈亮起。高扭矩模式會降低馬達最高轉速，可以提高作業效率。
馬達以自動切換模式運行時，若負載增加，會自動變換為高扭矩模式。
之後，如果負載再次下降，其會自動返回自動切換模式。
在高扭矩模式下，即使負載減少也不會變換到自動切換模式。

模式	無負荷速度
自動切換	6000 /min
高扭矩	4500 /min

註

- 模式僅在安裝電池且拉動開關時改變。
- 即便開啟/關閉開關或者取出/重新插入電池，也將保持當前的模式。

*3 如何使用掛鉤

掛鉤可以用來在操作期間暫時吊掛本機。

注意

- 使用掛鉤時，請檢查以確保主機身不會滑落，或因風等原因而不穩定等。
- 切勿將本機吊掛在腰帶或褲子上，否則可能會導致事故。

LED燈警示信號

該產品配備有保護工具本身及電池的功能。在操作期間，如果觸發任何保護功能，則 LED 燈會按表 3 中所述閃爍。

當有任何的保護功能被啟動時，請立即從開關上移開手指，並按照下述校正動作的指示。

HiKOKI 充電式工具電池重要注意事項

請務必使用本公司所指定的原廠電池。若未使用本公司所指定的電池，或使用經拆解及改裝的電池（例如，拆解後更換電池芯或其他內部零件），則本公司無法保證充電式工具的性能及操作安全。





註

為求改進，本手冊所載規格可能不預先通告而徑予更改。

疑難排解

若電動工具無法正常運作，請參閱下表的檢查項目。若問題仍無法解決，請洽當地經銷商或HiKOKI所認可的維修中心。

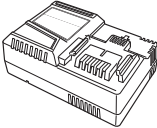
情況	可能原因	解決方法
工具無法運轉	無剩餘電池電量	為電池充電。
	觸發開關在電池插入時被按住。	安全功能已啟動。 釋放觸發開關一次然後再重新拉動，工具將會運作。
	電池未安裝妥當。	推動電池直至聽到咔嚓一聲。
工具突然停止	工具負載過重	除去造成工具負載過重的問題。
	過載保護運行中。	
	電池過熱。	讓電池冷卻下來。
	扳機開關已被按住5分鐘以上。	這不是故障。 馬達為防止工具故障而自動停止。
無法傾斜	傾斜桿未鬆開。	鬆開傾斜桿後嘗試使其傾斜。 進行必要調整後，擰緊傾斜桿。
鋸切效果不佳	鋸片磨損或鋸齒缺失。	將鋸片換新。
	螺栓鬆動。	鎖緊螺栓。
	鋸片被向後安裝。	按照正確的方向安裝鋸片。
開關無法拉動	開關鎖沒有充分按下。	將開關鎖完全按下。
鋸屑排出效果差	鋸屑積聚在鋸蓋內	清潔鋸蓋內部的鋸屑
電池無法安裝。	試圖安裝非該工具所指定的電池。	請安裝多伏特型電池。

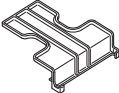
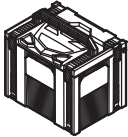
	(2XCZ)
	1
 5 mm	1
	1
 UC18YSL3	1
 BSL36A18X	2
	2
	1

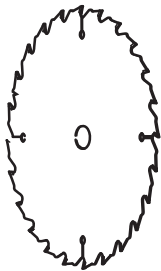

190 mm Saw blade

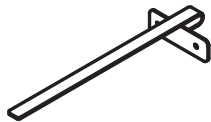
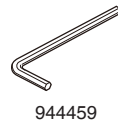

302691

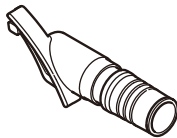

380086

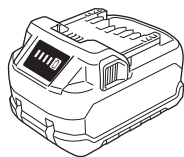

Multi volt (Li-ion)

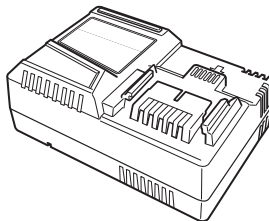

UC18YSL3 (14.4 V-18 V)

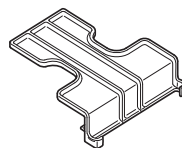

329897

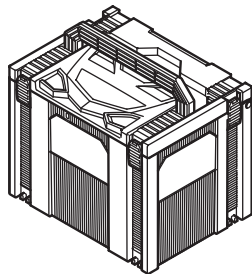

337528

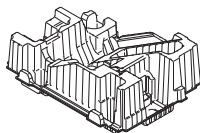

380751

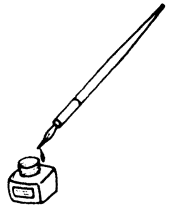

臺灣總代理：
明峯永業股份有限公司
電 話：**(02) 2792 – 0123**
地 址：臺北市內湖區新湖二路211號
網 址：**<https://www.hikoki-powertools.com.tw>**
服務信箱：**service@powertools.com.tw**

Koki Holdings Co., Ltd.