

HIKOKI

CG 36DC • CG 36DC(L)

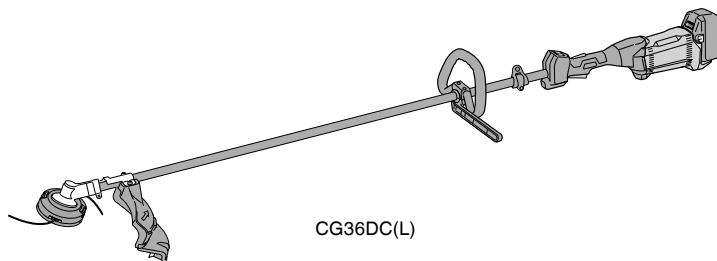
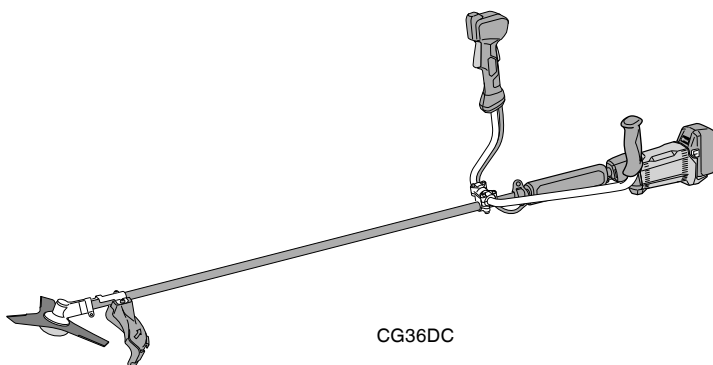

Handling instructions

1

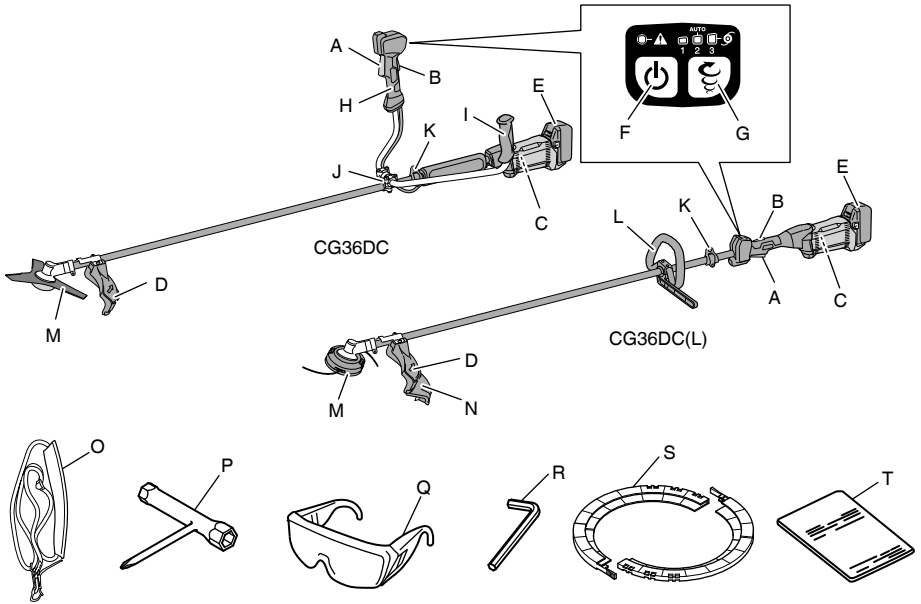

2

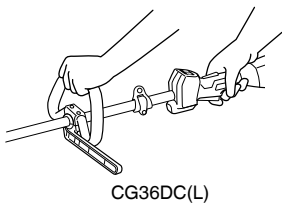
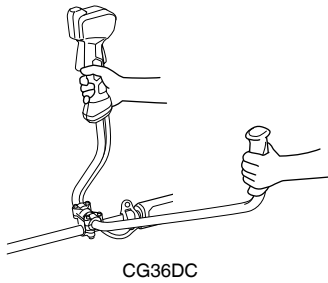

3

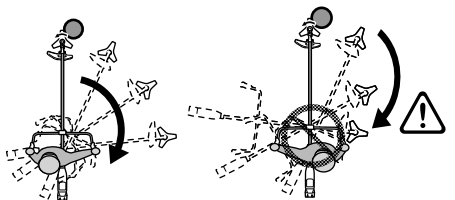
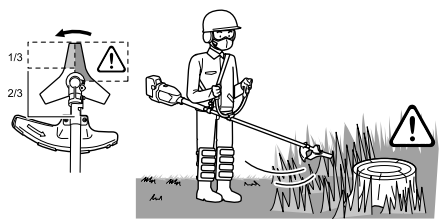

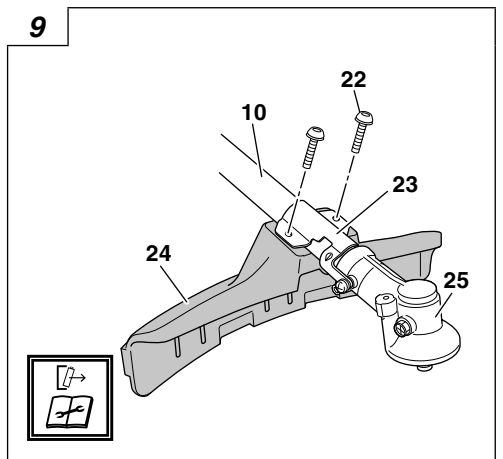
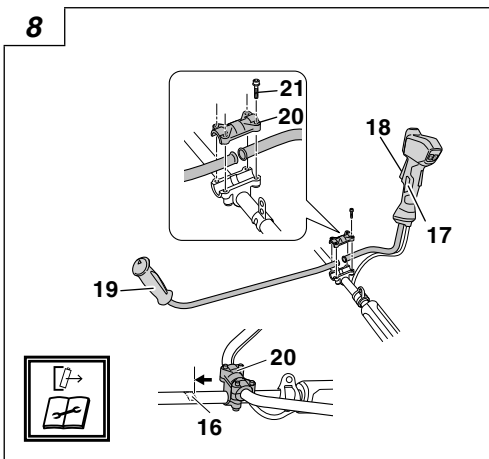
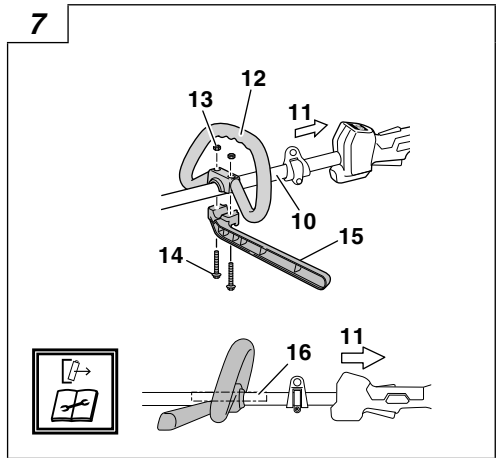
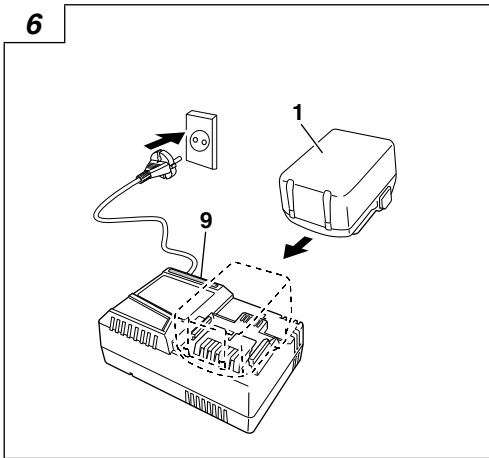
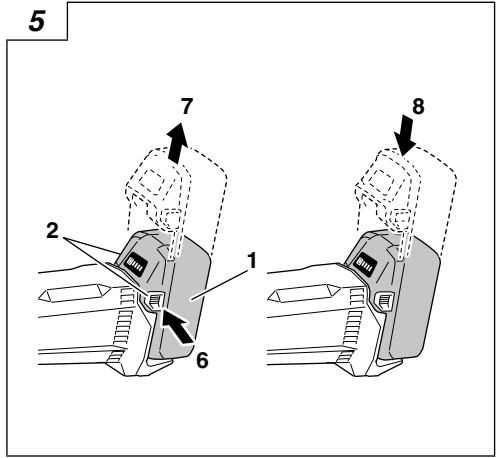
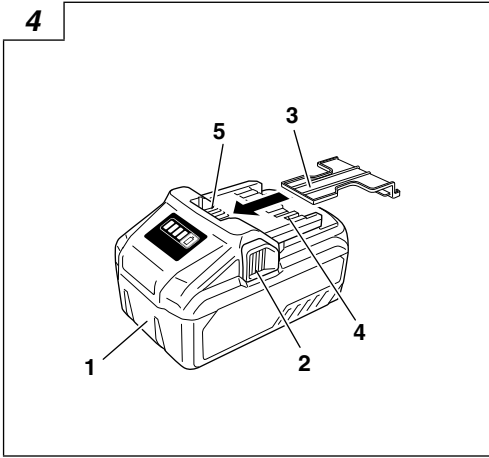

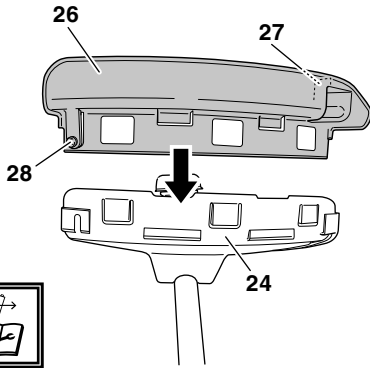
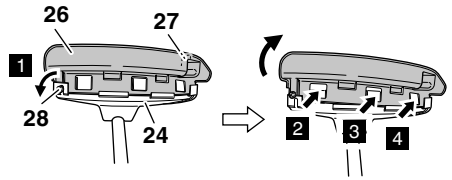
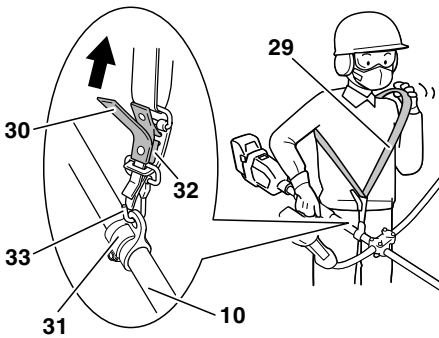
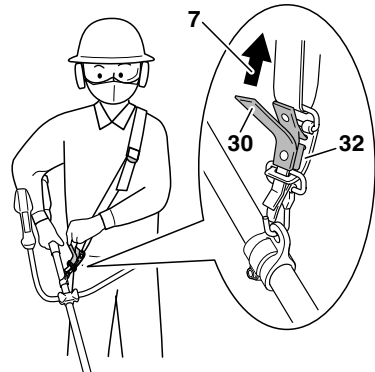
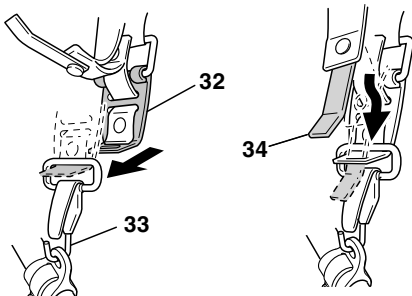
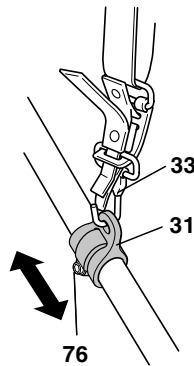
10**11****12****13****14****15**

16

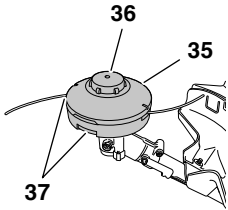

17

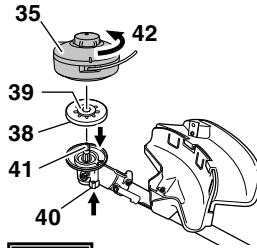

18

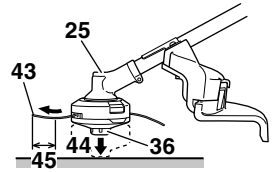

19

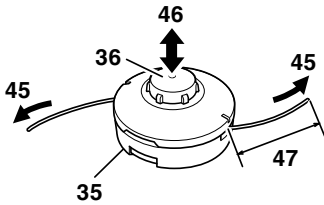

20

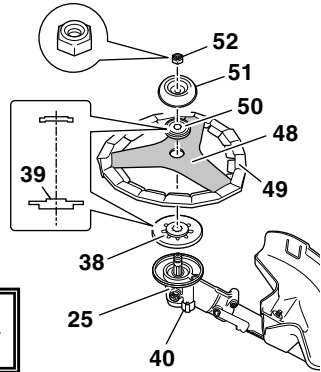

21

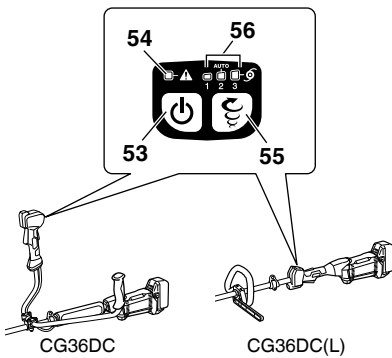

a

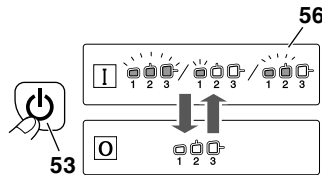

b

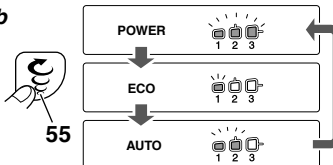

CG36DC

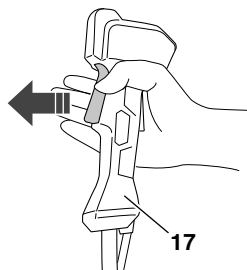
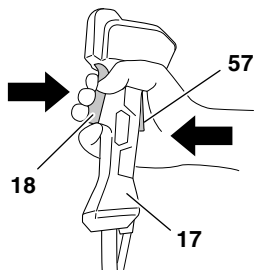

CG36DC(L)

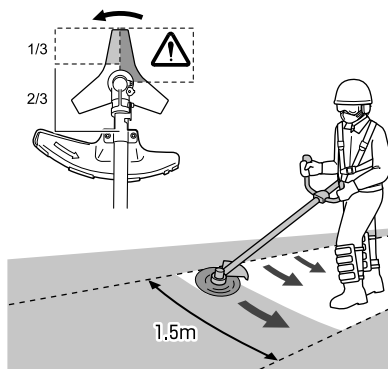
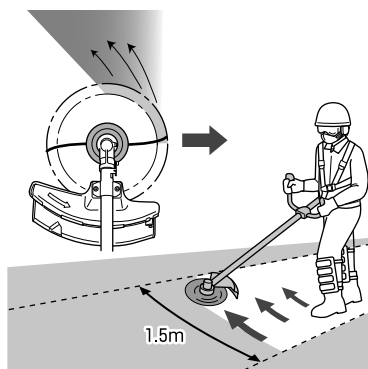
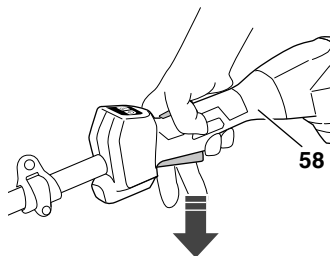
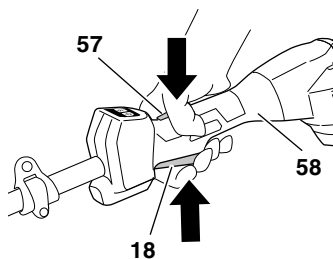

25

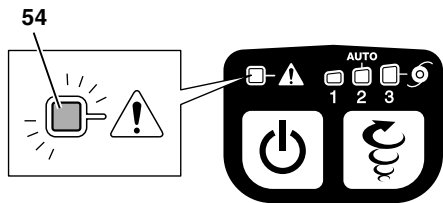

26

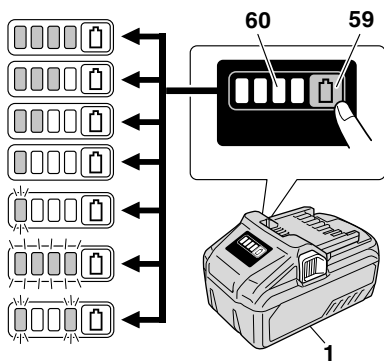

27

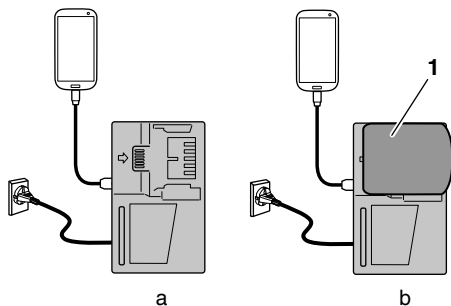

28

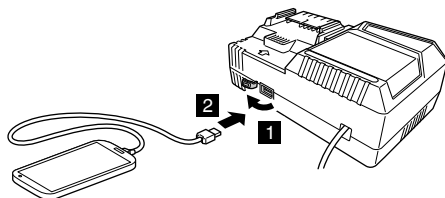

29

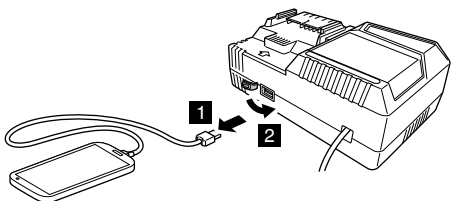

30

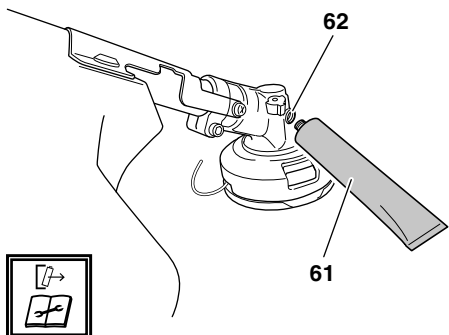

31

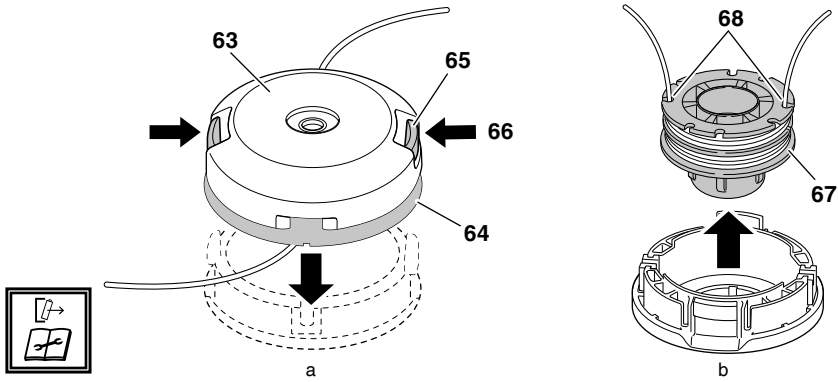

32

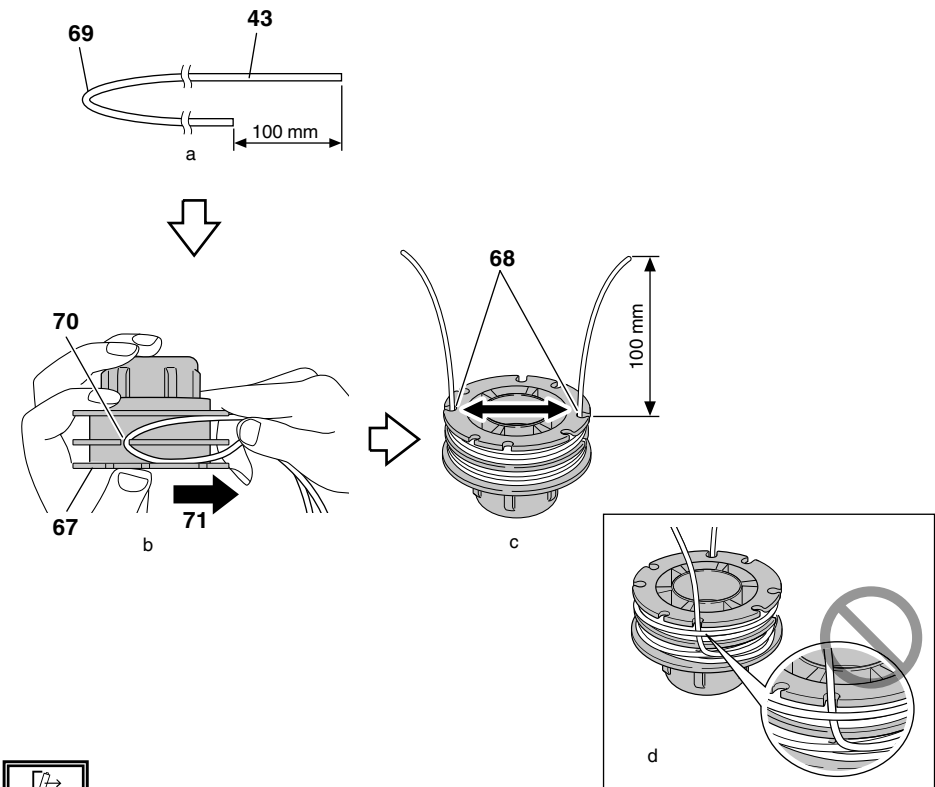

33

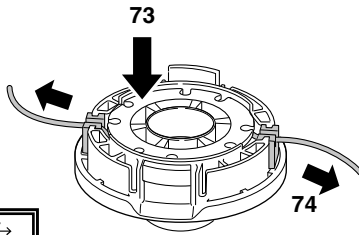
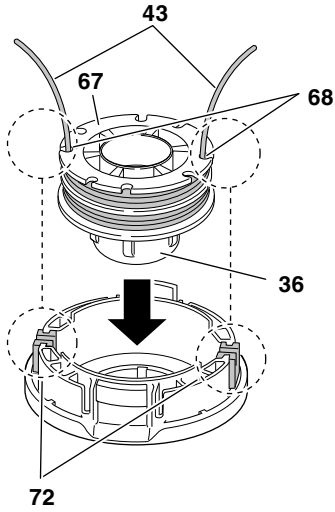

34

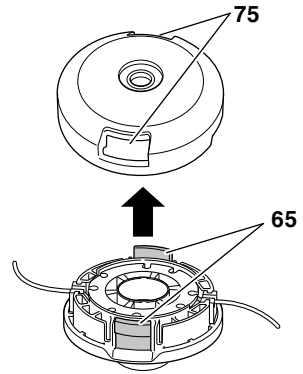

35

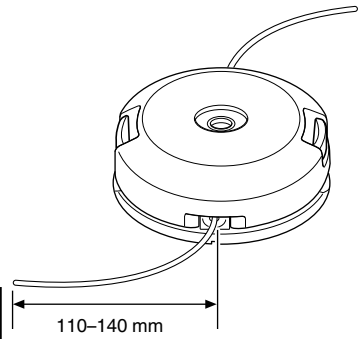



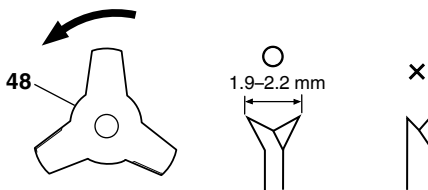













36



















SYMBOLS





WARNING



The following show symbols used for the machine. Be sure that you understand their meaning before use.

	CG36DC / CG36DC(L): Cordless Grass Trimmer / Brush Cutter
	To reduce the risk of injury, user must read instruction manual.
	Disconnect battery before maintenance
	Always wear eye protection.
	Always wear hearing protection.
	Do not use a power tool in the rain and moisture or leave it outdoors when it is raining.
	Beware of thrown objects
	The distance between the machine and bystanders shall be at least 15 m (50 ft)
	Wear head protection
	Wear hand protection
	Wear slip-resistant footwear
	Beware of blade thrust
	It is important that you read, fully understand and observe the following safety precautions and warnings. Careless or improper use of the unit may cause serious or fatal injury.
	Read, understand and follow all warnings and instructions in this manual and on the unit.
	Prohibited action
	Always wear eye, head and ear protectors when using this unit.
	Keep all children, bystanders and helpers 15 m away from the unit. If anyone approaches you, stop the unit and cutting attachment immediately.

	Be careful of thrown objects.
	Shows maximum shaft speed. Do not use the cutting attachment whose max rpm is below the shaft rpm.
	Gloves should be worn when necessary, e.g., when assembling cutting equipment.
	Use anti-slip and sturdy footwear.
	Blade thrust may occur when the spinning blade contacts a solid object in the critical area. A dangerous reaction may occur causing the entire unit and operator to be thrust violently. This reaction is called blade thrust. As a result, the operator may lose control of the unit which may cause serious or fatal injury. Blade thrust is more likely to occur in areas where it is difficult to see the material to be cut.
	(CG36DC) Indicate handle location. Arrows which show limits for handle positioning.
	(CG36DC(L))
	Direct current
	Rated voltage
	No-load speed
	Switching ON
	Switching OFF
	Eco mode
	Auto mode
	Power mode
	Protection function activates

Battery

	Lights ; The battery remaining power is over 75%
	Lights ; The battery remaining power is 50%–75%.
	Lights ; The battery remaining power is 25%–50%.
	Lights ; The battery remaining power is less than 25%

	Blinks ; The battery remaining power is nearly empty. Recharge the battery soonest possible.
	Blinks ; Output suspended due to high temperature. Remove the battery from the tool and allow it to fully cool down.
	Blinks ; Output suspended due to failure or malfunction. The problem may be the battery so please contact your dealer.

GENERAL POWER TOOL SAFETY WARNINGS

⚠ WARNING
Read all safety warnings, instructions, illustrations and specifications provided with this power tool.
Failure to follow all instructions listed below may result in electric shock, fire and/or serious injury.

Save all warnings and instructions for future reference.

The term "power tool" in the warnings refers to your mains-operated (corded) power tool or battery-operated (cordless) power tool.

1) Work area safety

- a) **Keep work area clean and well lit.**
Cluttered or dark areas invite accidents.
- b) **Do not operate power tools in explosive atmospheres, such as in the presence of flammable liquids, gases or dust.**
Power tools create sparks which may ignite the dust or fumes.
- c) **Keep children and bystanders away while operating a power tool.**
Distractions can cause you to lose control.

2) Electrical safety

- a) **Power tool plugs must match the outlet. Never modify the plug in any way. Do not use any adapter plugs with earthed (grounded) power tools.**
Unmodified plugs and matching outlets will reduce risk of electric shock.
- b) **Avoid body contact with earthed or grounded surfaces, such as pipes, radiators, ranges and refrigerators.**
There is an increased risk of electric shock if your body is earthed or grounded.
- c) **Do not expose power tools to rain or wet conditions.**
Water entering a power tool will increase the risk of electric shock.
- d) **Do not abuse the cord. Never use the cord for carrying, pulling or unplugging the power tool. Keep cord away from heat, oil, sharp edges or moving parts.**
Damaged or entangled cords increase the risk of electric shock.
- e) **When operating a power tool outdoors, use an extension cord suitable for outdoor use.**
Use of a cord suitable for outdoor use reduces the risk of electric shock.
- f) **If operating a power tool in a damp location is unavoidable, use a residual current device (RCD) protected supply.**
Use of an RCD reduces the risk of electric shock.

3) Personal safety

- a) **Stay alert, watch what you are doing and use common sense when operating a power tool. Do not use a power tool while you are tired or under the influence of drugs, alcohol or medication.**
A moment of inattention while operating power tools may result in serious personal injury.
- b) **Use personal protective equipment. Always wear eye protection.**
Protective equipment such as a dust mask, non-skid safety shoes, hard hat or hearing protection used for appropriate conditions will reduce personal injuries.

WHAT IS WHAT? (Fig. 1)

- A: Lever: Trigger for activating the unit.
B: Lock lever: Lever that prevents the accidental operation of the trigger.
C: Motor: Battery-driven motor.
D: Guard: Protects operator from flying debris.
E: Battery (sold separately): Power source to drive the unit.
F: Power switch: Switch for switching the unit's power ON or OFF.
G: Mode switch: Switch for adjusting the speed of the motor.
H: Handle right: Handle with lever located on the right side of the unit.
I: Handle left: Handle located on the left side of the unit.
J: Handle fixture: Secures the handles to the unit.
K: Hanger: Used for attaching a shoulder belt to the unit.
L: Loop handle
M: Cutting attachment (Nylon head / Blade)
N: Guard extension
O: Shoulder belt: Harness with release mechanism.
P: Combi box spanner
Q: Goggles
R: Hex bar wrench
S: Blade cover
T: Handling instructions

WARNINGS AND SAFETY INSTRUCTIONS

Pay special attention to statements preceded by the following words:

WARNING

Indicates a strong possibility of severe personal injury or loss of life, if instructions are not followed.

CAUTION

Indicates a possibility of personal injury or equipment damage, if instructions are not followed.

NOTE

Helpful information for correct function and use.

- c) **Prevent unintentional starting. Ensure the switch is in the off-position before connecting to power source and/or battery pack, picking up or carrying the tool.**
Carrying power tools with your finger on the switch or energising power tools that have the switch on invites accidents.
- d) **Remove any adjusting key or wrench before turning the power tool on.**
A wrench or a key left attached to a rotating part of the power tool may result in personal injury.
- e) **Do not overreach. Keep proper footing and balance at all times.**
This enables better control of the power tool in unexpected situations.
- f) **Dress properly. Do not wear loose clothing or jewellery. Keep your hair and clothing away from moving parts.**
Loose clothes, jewellery or long hair can be caught in moving parts.
- g) **If devices are provided for the connection of dust extraction and collection facilities, ensure these are connected and properly used.**
Use of dust collection can reduce dust-related hazards.
- h) **Do not let familiarity gained from frequent use of tools allow you to become complacent and ignore tool safety principles.**
A careless action can cause severe injury within a fraction of a second.
- 4) **Power tool use and care**
- a) **Do not force the power tool. Use the correct power tool for your application.**
The correct power tool will do the job better and safer at the rate for which it was designed.
- b) **Do not use the power tool if the switch does not turn it on and off.**
Any power tool that cannot be controlled with the switch is dangerous and must be repaired.
- c) **Disconnect the plug from the power source and/ or remove the battery pack, if detachable, from the power tool before making any adjustments, changing accessories, or storing power tools.**
Such preventive safety measures reduce the risk of starting the power tool accidentally.
- d) **Store idle power tools out of the reach of children and do not allow persons unfamiliar with the power tool or these instructions to operate the power tool.**
Power tools are dangerous in the hands of untrained users.
- e) **Maintain power tools and accessories. Check for misalignment or binding of moving parts, breakage of parts and any other condition that may affect the power tool's operation. If damaged, have the power tool repaired before use.**
Many accidents are caused by poorly maintained power tools.
- f) **Keep cutting tools sharp and clean.**
Properly maintained cutting tools with sharp cutting edges are less likely to bind and are easier to control.
- g) **Use the power tool, accessories and tool bits etc. in accordance with these instructions, taking into account the working conditions and the work to be performed.**
Use of the power tool for operations different from those intended could result in a hazardous situation.
- h) **Keep handles and grasping surfaces dry, clean and free from oil and grease.**
Slippery handles and grasping surfaces do not allow for safe handling and control of the tool in unexpected situations.
- 5) **Battery tool use and care**
- a) **Recharge only with the charger specified by the manufacturer.**
A charger that is suitable for one type of battery pack may create a risk of fire when used with another battery pack.
- b) **Use power tools only with specifically designated battery packs.**
Use of any other battery packs may create a risk of injury and fire.
- c) **When battery pack is not in use, keep it away from other metal objects, like paper clips, coins, keys, nails, screws or other small metal objects, that can make a connection from one terminal to another.**
Shorting the battery terminals together may cause burns or a fire.
- d) **Under abusive conditions, liquid may be ejected from the battery; avoid contact. If contact accidentally occurs, flush with water. If liquid contacts eyes, additionally seek medical help.**
Liquid ejected from the battery may cause irritation or burns.
- e) **Do not use a battery pack or tool that is damaged or modified.**
Damaged or modified batteries may exhibit unpredictable behaviour resulting in fire, explosion or risk of injury.
- f) **Do not expose a battery pack or tool to fire or excessive temperature.**
Exposure to fire or temperature above 130°C may cause explosion.
- g) **Follow all charging instructions and do not charge the battery pack or tool outside the temperature range specified in the instructions.**
Charging improperly or at temperatures outside the specified range may damage the battery and increase the risk of fire.
- 6) **Service**
- a) **Have your power tool serviced by a qualified repair person using only identical replacement parts.**
This will ensure that the safety of the power tool is maintained.
- b) **Never service damaged battery packs.**
Service of battery packs should only be performed by the manufacturer or authorized service providers.
- PRECAUTION**
Keep children and infirm persons away.
When not in use, tools should be stored out of reach of children and infirm persons.

CORDLESS GRASS TRIMMER / BRUSH CUTTER SAFETY WARNINGS

- a) **Do not use the machine in bad weather conditions, especially when there is a risk of lightning.** *This decreases the risk of being struck by lightning.*
- b) **Thoroughly inspect the area for wildlife where the machine is to be used.** *Wildlife may be injured by the machine during operation.*
- c) **Thoroughly inspect the area where the machine is to be used and remove all stones, sticks, wires, bones, and other foreign objects.** *Thrown objects can cause personal injury.*
- d) **Before using the machine, always visually inspect to see that the cutter or blade and the cutter or blade assembly are not damaged.** *Damaged parts increase the risk of injury.*
- e) **Follow instructions for changing accessories.** *Improperly tightened blade securing nuts or bolts may either damage the blade or result in it becoming detached.*
- f) **The rated rotational speed of the blade must be at least equal to the maximum rotational speed marked on the machine.** *Blades running faster than their rated rotational speed can break and fly apart.*
- g) **Wear eye, ear, head and hand protection.** *Adequate protective equipment will reduce personal injury by flying debris or accidental contact with the cutting line or blade.*
- h) **While operating the machine, always wear non-slip and protective footwear. Do not operate the machine when barefoot or wearing open sandals.** *This reduces the chance of injury to the feet from contact with the moving cutters or lines.*
- i) **While operating the machine, always wear safety footwear. Do not operate the machine when barefoot or wearing open sandals.** *This reduces the chance of injury to the feet from contact with a moving cutter, line or blade.*
- j) **While operating the machine, always wear long trousers.** *Exposed skin increases the likelihood of injury from thrown objects.*
- k) **Keep bystanders away while operating the machine.** *Thrown debris can result in serious personal injury.*
- l) **Always use two hands when operating the machine.** *Holding the machine with both hands will avoid loss of control. (Fig. 2)*
- m) **Hold the machine by the insulated gripping surfaces only, because the cutting line or blade may contact hidden wiring.** *Cutting line or blades contacting a "live" wire may make exposed metal parts of the machine "live" and could give the operator an electric shock.*
- n) **Always keep proper footing and operate the machine only when standing on the ground.** *Slippery or unstable surfaces may cause a loss of balance or control of the machine.*
- o) **Do not operate the machine on excessively steep slopes.** *This reduces the risk of loss of control, slipping and falling which may result in personal injury.*
- p) **When working on slopes, always be sure of your footing, always work across the face of slopes, never up or down and exercise extreme caution when changing direction.** *This reduces the risk of loss of control, slipping and falling which may result in personal injury.*
- q) **Keep all parts of the body away from the cutter, line or blade when the machine is operating. Before you start the machine, make sure the cutter, line or blade is not contacting anything. A moment of inattention while operating the machine may result in injury to yourself or others.**
- r) **Do not operate the machine above waist height.** *This helps prevent unintended cutter or blade contact and enables better control of the machine in unexpected situations.*
- s) **When cutting brush or saplings that are under tension, be alert for spring back.** *When the tension in the wood fibres is released, the brush or sapling may strike the operator and/or throw the machine out of control.*
- t) **Use extreme caution when cutting brush and saplings.** *The slender material may catch the blade and be whipped toward you or pull you off balance.*
- u) **Maintain control of the machine and do not touch cutters, lines or blades and other hazardous moving parts while they are still in motion.** *This reduces the risk of injury from moving parts.*
- v) **When clearing jammed material or servicing the machine, make sure the switch is off and the battery pack is removed.** *Unexpected starting of the machine while clearing jammed material or servicing may result in serious personal injury.*
- w) **Carry the machine with the machine switched off and away from your body.** *Proper handling of the machine will reduce the likelihood of accidental contact with a moving cutter, line or blade.*
- x) **When transporting or storing the machine, always fit the cover on metal blades.** *Proper handling of the machine will reduce the likelihood of accidental contact with the blade.*
- y) **Only use replacement cutters, lines, cutting heads and blades specified by the manufacturer.** *Incorrect replacement parts may increase the risk of breakage and injury.*

BLADE THRUST CAUSES AND RELATED WARNINGS

Blade thrust is a sudden sideways, forward or backward motion of the machine, which may occur when the blade jams or catches on an object such as a sapling or a tree stump. It can be violent enough to cause the machine and/or operator to be propelled in any direction, and possibly lose control of the machine.

Blade thrust and its related hazards can be avoided by taking proper precautions as given below.

- a) **Maintain a firm grip with both hands on the machine and position your arms to resist blade thrust. Position your body to the left side of the machine.** *Blade thrust can increase the risk of injury due to the machine moving unexpectedly. Blade thrust can be controlled by the operator if proper precautions are taken.*
- b) **If the blade binds, or when interrupting a cut for any reason, switch the machine off and hold the machine motionless in the material until the blade comes to a complete stop. While the blade is binding, never attempt to remove the machine from the material or pull the machine backward while the blade is in motion, otherwise blade thrust may occur. Investigate and take corrective actions to eliminate the cause of blade binding.**
- c) **Do not use blunt or damaged blades.** *Blunt or damaged blades increase the risk of jamming or catching on an object, resulting in blade thrust.*
- d) **Always maintain good visibility of the material being cut.** *Blade thrust is more likely to occur in areas where it is difficult to see the material being cut.*
- e) **If you are approached by another person while operating the machine, switch the machine off.** *There is an increased risk of injury to other persons being struck by the moving blade in the event of blade thrust.*

ADDITIONAL SAFETY WARNINGS

IMPORTANT READ CAREFULLY BEFORE USE KEEP FOR FUTURE REFERENCE

Safe operation practices

● Training

- Read the instructions carefully. Be familiar with the controls and the correct use of the machine.
- Never allow people unfamiliar with these instructions or children to use the machine. Local regulations can restrict the age of the operator.
- Keep in mind that the operator or user is responsible for accidents or hazards occurring to other people or their property.

● Preparation

- Before use check the supply and extension cord for signs of damage or aging. If the cord becomes damaged during use, disconnect the cord from the supply immediately.

DO NOT TOUCH THE CORD BEFORE DISCONNECTING THE SUPPLY.

- Do not use the machine if the cord is damaged or worn.
- Before use, always visually inspect the machine for damaged, missing or misplaced guards or shields.
- Never operate the machine while people, especially children, or pets are nearby.
- Never replace nylon head with metallic cutting means.

● Operation

- Wear eye protection, stout shoes and long trousers at all times while operating the machine.
- Avoid using the machine in bad weather conditions especially when there is a risk of lightning.
- Use the machine only in daylight or good artificial light.
- Never operate the machine with damaged guards or shields or without guards or shields in place.
- Switch on the motor only when the hands and feet are away from the cutting means.
- Always disconnect the machine from the power supply (i.e. remove the plug from the mains or remove the disabling device)

- whenever the machine is left user;
- before clearing a blockage;
- before checking, cleaning or working on the machine;
- after striking a foreign object to inspect the machine for damage;
- if the machine starts to vibrate abnormally, for immediately check.

- Take care against injury to feet and hands from the cutting means.
- Always ensure that the ventilation openings are kept clear of debris.
- Never modify the unit/machine in any way. Do not use your unit/machine for any job except that for which it is intended.
- If the unit striking a hard object or there appears to be excessive vibration, inspect it carefully to check there is no damage, cracks or deformation. Using a tool that is damaged, cracked or deformed could result in injury.
- The guard extension is equipped with the knife. Never place your hands near the knife.
- Do not wear multiple belt harnesses or multiple shoulder harnesses at the same time. When wearing the shoulder belt, make sure that other attachments do not interfere with the quick release bracket of the shoulder belt.

● Maintenance, transport and storage

- Disconnect the machine from the power supply (i.e. remove the plug from the mains or remove the disabling device) before carrying out maintenance or cleaning work.
- Use only the manufacturer's recommended replacement parts and accessories.
- Inspect and maintain the machine regularly. Have the machine repaired only by an authorized repairer.
- When not in use, store the machine out of the reach of children.
- When transporting in a vehicle or storage, cover blade with blade cover.
- When cutting edges become dull, re-sharpen or file as shown in the illustration or contact a HiKOKI Authorized Service Center.

Incorrect sharpening may cause excessive vibration.

● KICKBACK DANGER (Fig. 3)

When using metal cutting attachments such as blades, contact with obstacles such as trees or other hard surfaces with the front or right portion of the spinning attachment may force the unit to catch on an obstacle, resulting in a kickback reaction towards the right side of the operator.

Kickback may occur when the cutting attachment comes into contact with tree stumps or rocks hidden behind weeds. Always make sure there are no obstacles hidden by weeds before starting work.

To minimize the danger of kickbacks when they do occur, always position the unit to the right side of the body during operation. With the operator properly positioned as the cutting attachment rotates, this will reduce the danger of the unit's direct contact with the body.

PRECAUTIONS FOR CORDLESS GRASS TRIMMER / BRUSH CUTTER

WARNING

- Exercise patience in all work with the tool. And dress properly to keep warm.
- Plan all work ahead to prevent accidents.
- Do not operate the tool at night or under bad weather conditions when visibility is poor. And do not operate the tool when it is raining or right after it has been raining. Working on slippery ground could lead to an accident if you lose your balance.
- Inspect the cutting attachment before starting work. Do not use the tool if the cutting attachment is cracked, scarred or bent. Make sure the cutting attachment is properly attached. A cutting attachment that falls apart or comes loose during operation could cause an accident.
- Be sure to attach the guard before starting work. Operating the tool without this parts could lead to injury.
- Be sure to attach the handle before starting work. Make sure it is not loose but properly attached before starting work. Hold the handle firmly during work and do not swing the tool around, but use the correct posture and maintain your balance. Losing your balance during work could lead to an injury.
- Take care when starting the motor. Place the tool on level ground. Do not operate the tool within 15 m of people or animals. Make sure that the cutting attachment does not come into contact with the ground or trees and plants. A careless start could lead to injury.
- Do not secure the lock lever. Accidentally pulling back the lever could lead to unexpected injury.
- Before leaving the tool, press the power switch to turn it off.

10. Operate the tool with care near electric cables, gas pipes and similar installations.
 11. Look out for and remove empty cans, wire, stones or other obstacles before starting work. And do not work near tree roots or rocks.
Working in such areas could damage the cutting attachment or lead to injury.
 12. Never touch the cutting attachment during operation.
Also make sure it does not come into contact with your hair, clothes, etc.
 13. In the following situations, turn off the motor and check that the cutting attachment has stopped rotating.
To move to another work area.
To remove rubbish or grass that has become stuck in the tool.
To remove from the work area obstacles or the rubbish, grass and chips generated by trimming.
To lay down the tool.
Doing this with the cutting attachment still rotating could lead to unexpected accidents.
 14. Do not use the tool within 15 m of another person.
When you work with someone else, maintain a distance of more than 15 m.
Flying chips could lead to unexpected accidents.
When working on unstable surfaces like slopes, make sure that your co-worker is not exposed to any hazards.
Use whistles or other means for calling the attention of your co-workers.
 15. When grass and other objects become entangled in the cutting attachment, turn off the motor and make sure the cutting attachment has stopped rotating before removing them.
Removing objects from the cutting attachment when it is still rotating will lead to injury.
Continuing operation when foreign matter is stuck in the cutting attachment may lead to damage.
 16. If the tool is operating poorly and produces strange noise or vibrations, turn off the motor immediately and ask your dealer to have it inspected and repaired.
Continued use under these conditions could lead to injury or tool damage.
 17. If you drop or bump the tool, inspect it carefully to check there is no damage, cracks or deformation.
Using a tool that is damaged, cracked or deformed could result in injury.
 18. Secure the tool during vehicle transport to ensure that it lies still.
Failure to heed this warning may result in an accident.
 19. When transporting or moving the tool, hold the main pipe with both hands, and keep the blade away from your body when carrying.
 20. Put the blade cover in the included tool bag so that it can be used right away when needed, and always keep it near the tool.
 21. When transporting or storing the tool, remove the battery, and remove the blade or cover it with the blade cover.
 22. When not working, remove the shoulder belt from the tool.
 23. Make sure that the battery is installed firmly. If it is at all loose it could come off and cause an accident.
 24. Do not use the product if the tool or the battery terminals (battery mount) are deformed.
Installing the battery could cause a short circuit that could result in smoke emission or ignition.
 25. Keep the tool's terminals (battery mount) free of swarf and dust.
 - Prior to use, make sure that swarf and dust have not collected in the area of the terminals.
 - During use, try to avoid swarf or dust on the tool from falling on the battery.
 - When suspending operation or after use, do not leave the tool in an area where it may be exposed to falling swarf or dust.
Doing so could cause a short circuit that could result in smoke emission or ignition.
26. Always use the tool and battery at temperatures between -5°C and 40°C.
 27. Do not give a strong shock to the switch panel or break it. It may lead to a trouble.
- CAUTION**
1. Do not turn on the cutting attachment for cutting objects other than grass. Do not operate the tool in water puddles and make sure that soil does not come into contact with the cutting attachment.
 2. The tool contains precision parts and should not be dropped, exposed to strong impact or water.
The tool could be damaged or malfunction.
 3. When the tool is to be stored after use or be transported, remove the cutting attachment.
 4. Do not expose the tool to insecticide and other chemicals.
Such chemicals could cause cracking and other damage.
 5. Replace warning labels with new labels when they become difficult to recognize or illegible and when they start to peel.
Ask your dealer to provide the warning labels.

PRECAUTIONS FOR BATTERY AND CHARGER (sold separately)

1. Always charge the battery at an ambient temperature of 0–40°C. A temperature of less than 0°C will result in over charging which is dangerous. The battery cannot be charged at a temperature greater than 40°C.
The most suitable temperature for charging is that of 20–25°C.
2. Do not allow foreign matter to enter the hole for connecting the rechargeable battery.
3. Never disassemble the rechargeable battery or charger.
4. Never short-circuit the rechargeable battery.
Short-circuiting the battery will cause a great electric current and overheat. It results in burn or damage to the battery.
5. Do not dispose of the battery in fire.
If the battery is burnt, it may explode.
6. Bring the battery to the shop from which it was purchased as soon as the post-charging battery life becomes too short for practical use. Do not dispose of the exhausted battery.
7. Do not insert objects into the air ventilation slots of the charger.
Inserting metal objects or flammable into the charger air ventilation slots will result in an electrical shock hazard or damage to the charger.

CAUTION ON LITHIUM-ION BATTERY

To extend the lifetime, the lithium-ion battery equips with the protection function to stop the output.
In the cases of 1 to 3 described below, when using this product, even if you are pulling the switch, the motor may stop. This is not the trouble but the result of protection function.

1. When the battery power remaining runs out, the motor stops.
In such case, charge it up immediately.
2. If the tool is overloaded, the motor may stop. In this case, release the switch of tool and eliminate causes of overloading. After that, you can use it again.

- If the battery is overheated under overload work, the battery power may stop.
In this case, stop using the battery and let the battery cool. After that, you can use it again.

Furthermore, please heed the following warning and caution.

WARNING

In order to prevent any battery leakage, heat generation, smoke emission, explosion and ignition beforehand, please be sure to heed the following precautions.

- Make sure that swarf and dust do not collect on the battery.
 - During work make sure that swarf and dust do not fall on the battery.
 - Make sure that any swarf and dust falling on the power tool during work do not collect on the battery.
 - Do not store an unused battery in a location exposed to swarf and dust.
 - Before storing a battery, remove any swarf and dust that may adhere to it and do not store it together with metal parts (screws, nails, etc.).
- Do not pierce battery with a sharp object such as a nail, strike with a hammer, step on, throw or subject the battery to severe physical shock.
- Do not use an apparently damaged or deformed battery.
- Do not use the battery for a purpose other than those specified.
- If the battery charging fails to complete even when a specified recharging time has elapsed, immediately stop further recharging.
- Do not put or subject the battery to high temperatures or high pressure such as into a microwave oven, dryer, or high pressure container.
- Keep away from fire immediately when leakage or foul odor are detected.
- Do not use in a location where strong static electricity generates.
- If there is battery leakage, foul odor, heat generated, discolored or deformed, or in any way appears abnormal during use, recharging or storage, immediately remove it from the equipment or battery charger, and stop use.
- Do not immerse the battery or allow any fluids to flow inside. Conductive liquid ingress, such as water, can cause damage resulting in fire or explosion. Store your battery in a cool, dry place, away from combustible and flammable items. Corrosive gas atmospheres must be avoided.
- Do not give a strong shock to the switch panel or break it. It may lead to a trouble.

CAUTION

- If liquid leaking from the battery gets into your eyes, do not rub your eyes and wash them well with fresh clean water such as tap water and contact a doctor immediately.
If left untreated, the liquid may cause eye-problems.
- If liquid leaks onto your skin or clothes, wash well with clean water such as tap water immediately.
There is a possibility that this can cause skin irritation.
- If you find rust, foul odor, overheating, discolor, deformation, and/or other irregularities when using the battery for the first time, do not use and return it to your supplier or vendor.

WARNING

If an electrically conductive foreign object enters the terminals of the lithium ion battery, a short-circuit may occur resulting in the risk of fire. Please observe the following matters when storing the battery.

- Do not place electrically conductive cuttings, nails, steel wire, copper wire or other wire in the storage case.
- Either install the battery in the power tool or store by securely pressing into the battery cover until the ventilation holes are concealed to prevent short-circuits (See Fig. 4).

REGARDING LITHIUM-ION BATTERY TRANSPORTATION

When transporting a lithium-ion battery, please observe the following precautions.

WARNING

Notify the transporting company that a package contains a lithium-ion battery, inform the company of its power output and follow the instructions of the transportation company when arranging transport.

- Lithium-ion batteries that exceed a power output of 100 Wh are considered to be in the freight classification of Dangerous Goods and will require special application procedures.
- For transportation abroad, you must comply with international law and the rules and regulations of the destination country.

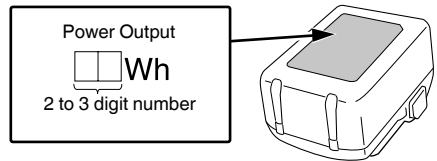

USB DEVICE CONNECTION PRECAUTIONS (UC18YSL3)

When an unexpected problem occurs, the data in a USB device connected to this product may be corrupted or lost. Always make sure to back up any data contained in the USB device prior to use with this product.

Please be aware that our company accepts absolutely no responsibility for any data stored in a USB device that is corrupted or lost, nor for any damage that may occur to a connected device.

WARNING

- Prior to use, check the connecting USB cable for any defect or damage.
Using a defective or damaged USB cable can cause smoke emission or ignition.
- When the product is not being used, cover the USB port with the rubber cover.
Buildup of dust etc. in the USB port can cause smoke emission or ignition.

NOTE

- There may be an occasional pause during USB recharging.
- When a USB device is not being charged, remove the USB device from the charger.
Failure to do so may not only reduce the battery life of a USB device, but may also result in unexpected accidents.
- It may not be possible to charge some USB devices, depending on the type of device.

NAMES OF PARTS (Fig. 2–Fig. 36)

1	Battery	31	Hanger
2	Latch	32	Bracket
3	Battery cover	33	Hook
4	Terminals	34	Quick-release bracket
5	Ventilation holes	35	Nylon head
6	Push	36	Button
7	Pull out	37	Wear limit mark (2 marks)
8	Insert	38	Cutter holder (A)
9	Charge indicator lamp	39	25 mm diameter boss
10	Main pipe	40	Stopper pin
11	Grip side	41	Threaded fastener of the gear case
12	Loop handle	42	Nylon head tightening direction (left rotation)
13	M6 nuts	43	Nylon line
14	M6 x 43 bolts	44	Tap
15	Handle fixture (loop handle type)	45	Extends in 30 mm increments
16	Handle location label	46	Tap/release
17	Handle right	47	Appropriate length 110–140 mm
18	Lever	48	Blade
19	Handle left	49	Cutter cover
20	Handle fixture (bike handlebars type)	50	Cutter holder (B)
21	M5 x 25 hex. Socket bolts	51	Cutter holder cap
22	M6 x 25 hex. Socket button bolts	52	Nut
23	Cover bracket	53	Power switch
24	Guard	54	Warning signal
25	Gear case	55	Mode switch
26	Guard extension	56	Mode Indicator lamp
27	Knife	57	Lock lever
28	Bolt	58	Grip
29	Shoulder belt	59	Battery level indicator switch
30	Quick-release belt	60	Battery level indicator lamp

61	Grease	69	U-shaped end
62	Screw hole of side	70	Groove
63	Cover	71	Direction to wind nylon cord
64	Case	72	Eyelet line guide
65	Locking tab	73	While holding the reel
66	Press tabs (2 areas)	74	String the line through the eyelet line guide
67	Reel	75	Locking holes of cover (2 holes)
68	Stopper holes	76	Bolt (for Hanger)

SPECIFICATIONS

1. Power tool

Model	CG36DC	CG36DC(L)
Voltage	36 V	
Pole type	Straight type	
Cutting capacity diameter	440 mm	
Rotation direction	Counterclockwise as seen from above	
No-load speed	Power	6000 /min
	Auto	4700 /min
	Eco	3000 /min
Operating time under no load* (BSL36B18)	Power	27 min
	Auto	50 min
	Eco	115 min
Battery available for this tool**	Multi volt battery	
Weight***	5.4 kg	5.2 kg

* When supplied rechargeable battery is fully charged The data in the above table is provided only as an example. Since ambient temperature, rechargeable battery characteristics, etc. can vary widely the above should only be used as a rough guideline. Conditions: When using the blade, the mode switch is set to Power, Auto, or Eco. (lever left ON all the time)

** AC/DC Adapter (ET36A) cannot be used. Existing batteries (BSL3660/3626X/3626/3625/3620, BSL18 and BSL14 series) cannot be used with this tool.

*** Weight: blade, guard and shoulder belt included

NOTE

Due to HiKOKI's continuing program of research and development, the specifications herein are subject to change without prior notice.

2. Battery (sold separately)

Model	BSL36B18
Voltage	36 V / 18 V (Automatic Switching*)
Battery capacity	4.0 Ah / 8.0 Ah
	(Automatic Switching*)

* The tool itself will automatically switch over.

STANDARD ACCESSORIES

In addition to the main unit (1 unit), the package contains the accessories listed on page 23.

Standard accessories are subject to change without notice.

APPLICATIONS

Trimming, scaling and mowing of weed.

CHARGING

Before using the power tool, charge the battery as follows.

<UC18YSL3 (sold separately)>

1. Connect the charger's power cord to the receptacle.

When connecting the plug of the charger to a receptacle, the charge indicator lamp will blink in red (See **Table 1**).

2. Insert the battery into the charger.

Firmly insert the battery into the charger as shown in **Fig. 6** (on page 3).

3. Charging







When inserting a battery in the charger, charging will commence and the charge indicator lamp will blink in blue.

When the battery becomes fully recharged, the charge indicator lamp will light up in green. (See **Table 1**)

(1) Charge indicator lamp indication

The indications of the charge indicator lamp will be as shown in **Table 1**, according to the condition of the charger or the rechargeable battery.

Table 1: Indications of the charge indicator lamp

ON/OFF at 0.5 sec. intervals (RED) 	Before charging*1
Lights for 0.5 sec. at intervals of 1 sec. (BLUE) 	Charged at less than 50%
Lights for 1 sec. at intervals of 0.5 sec. (BLUE) 	Charged at less than 80%
Lights continuously (BLUE) 	Charged at more than 80%
Lights continuously (Continuous buzzer sound: about 6 sec.) (GREEN) 	Charging complete
ON/OFF at 0.3 sec. intervals (RED) 	Overheat standby*2
ON/OFF at 0.1 sec. intervals (Intermittent buzzer sound; about 2 sec.) (PURPLE) 	Charging impossible*3

NOTE

*1 If the red lamp continues to blink even after the charger has been attached, check to confirm that the battery has been fully inserted.

*2 Battery overheated. Unable to charge.

Although charging will start once the battery has cooled down even when left in situ, the best practice is to remove the battery and allow it to cool down in a shaded, well-ventilated location before charging.

*3 Malfunction in the battery or the charger

– Fully insert the battery.

– Check to confirm that no foreign matter is stuck to the battery mount or terminals. If there are no foreign objects, it is probable that the battery or charger is malfunctioning. Take it to your authorized Service Center.

○ When the battery charger has been continuously used, the battery charger will be heated, thus constituting the cause of the failures. Once the charging has been completed, give 5 minutes rest until the next charging.

(2) Regarding the temperatures and charging time of the battery. (See **Table 2**)

Table 2

Model	UC18YSL3	
Type of battery	Li-ion	
Charging voltage	14.4–18 V	
Temperatures at which the battery can be recharged	0°C–50°C	
Charging time for battery capacity, approx. (At 20°C)	1.5 Ah	15 min
	2.0 Ah	20 min
	2.5 Ah	25 min
	3.0 Ah	20 min (BSL1430C, BSL1830C: 30 min)
	4.0 Ah	26 min (BSL1840M: 40 min)
	5.0 Ah	32 min
Charging time for multi volt battery capacity, approx. (At 20°C)	6.0 Ah	38 min
	1.5 Ah (× 2 unit)	20 min
	2.5 Ah (× 2 unit)	32 min
	4.0 Ah (× 2 unit)	52 min
Number of battery cells	4–10	
Charging voltage for USB	5 V	
Charging current for USB	2 A	
Weight	0.6 kg	

NOTE

○ The recharging time may vary according to ambient temperature and power source voltage.

○ If charging takes a long time

– Charging will take longer at extremely low ambient temperatures. Charge the battery in a warm location (such as indoors).

– Do not block the air vent. Otherwise the interior will overheat, reducing the charger's performance.

– If the cooling fan is not operating, contact a HIKOKI Authorized Service Center for repairs.

4. **Disconnect the charger's power cord from the receptacle.**

5. Hold the charger firmly and pull out the battery.

NOTE

Be sure to pull out the battery from the charger after use, and then keep it.

Regarding electric discharge in case of new batteries, etc.

As the internal chemical substance of new batteries and batteries that have not been used for an extended period is not activated, the electric discharge might be low when using them the first and second time. This is a temporary phenomenon, and normal time required for recharging will be restored by recharging the batteries 2–3 times.

How to make the batteries perform longer.

- (1) Recharge the batteries before they become completely exhausted. When you feel that the power of the tool becomes weaker, stop using the tool and recharge its battery. If you continue to use the tool and exhaust the electric current, the battery may be damaged and its life will become shorter.
- (2) Avoid recharging at high temperatures. A rechargeable battery will be hot immediately after use. If such a battery is recharged immediately after use, its internal chemical substance will deteriorate, and the battery life will be shortened. Leave the battery and recharge it after it has cooled for a while.

MOUNTING AND OPERATION

Action	Figure	Page
Removing and inserting the battery	5	3
Charging	6	3
Remaining battery indicator	26	7
Charging a USB device from a electrical outlet	27-a	7
Charging a USB device and battery from a electrical outlet	27-b	7
How to recharge USB device	28	7
When charging of USB device is completed	29	7
Selecting accessories	—	24

ASSEMBLY PROCEDURES

WARNING

Pull out battery before doing any assembly.

1. Installing of handle

- (1) Loop handle type (Fig. 7)
Attach the handle to the main pipe with the angle towards the grip side.
Adjust the location to the most comfortable position before operation.
Make sure to securely attach the handle with the 2 bolts.

NOTE

Install the loop handle between the arrow marks on the handle location label.

- (2) Bike handle type (Fig. 8)

Remove the handle fixture from the assembly.
Place the handle and attach the handle fixture with four bolts lightly. Adjust to appropriate position. Then attach it firmly with the bolts.

NOTE

The bike handle can be adjusted by moving it forward to the arrow mark on the handle location label.

2. Installing of guard

WARNING

- If an incorrect or faulty guard is fitted, this may cause serious personal injury.

CAUTION

The guard extension is equipped with the knife. Be careful with handling it.

Align the guard with the cover bracket and secure it to the main pipe, using the bolt and cover bracket. (Fig. 9)

NOTE

- The guard extension is already attached to the guard at the time of purchase.
- The cover bracket may come already mounted to the gear case.

2-1 When using the semi-auto nylon head

When using a the nylon head, attach the guard extension to the guard, then tighten the bolt. (Fig. 10)

2-2 When using the blade

WARNING

Remove the guard extension when using metal or plastic blades. Failure to do so may result in injury or damage to the guard.

NOTE

Wear gloves as the extension has the knife.

Loosen the bolt. Then push the three square tabs on the guard one by one in order, and remove the guard extension. (Fig. 11)

3. Installing the shoulder belt

WARNING

- Be sure to attach the shoulder belt so that the grass trimmer / brush cutter can be carried correctly.
- If you get the feeling the tool is not operating normally, turn off the motor immediately, remove the quick-release bracket of the shoulder belt and remove the tool.

CAUTION

- If you do not support the tool when you pull the quick-release belt, it may fall causing injury or damage.
Hold the main pipe with one hand while you pull with the other hand.
- Make sure the quick-release function operates normally before you start working.
- Before attaching, check to confirm that the belt is not cut, frayed, or damaged.
- Check to confirm that the hook and hanger are neither deformed nor damaged.
- Once attached, press down on the main unit to confirm that the hook does not detach easily and that the shoulder belt is not loose.
- Check to confirm that the quick release function operates as it should.

- (1) Place the shoulder belt on the shoulder as shown in Fig. 12 and engage it with the hanger on the tool. Adjust the shoulder belt to suitable length.

- (2) To remove the tool from the shoulder belt, support the tool by holding the main pipe with one hand and use the other hand to pull the quick-release belt as shown in Fig. 13 to free it from the bracket.

- (3) To strap on the tool, insert the bracket in the hook and insert the quick-release bracket over the hook and into the wide opening of the bracket. (Fig. 14)

Gently pull the shoulder belt to make sure that it is properly attached.

NOTE

You may need to adjust the position of the hanger to balance the unit. To do so, loosen bolt and adjust the position of hanger. After adjusting as necessary, make sure to securely tighten the bolt. (Fig. 15)

4. Installation of cutting attachment

WARNING

- Install the cutting attachment properly and securely as instructed in the handling instructions.
If not attached properly or securely, it may come off and cause serious and/or fatal injury.
- Always use genuine HiKOKI cutting attachments and metal fittings.

4.1 Installation of semi-auto nylon head

(1) Function

Automatically feeds more nylon cutting line when it is tapped at low rpm (not greater than 4500 /min).

Specifications

Code No.	Type of attaching screw	Direction of rotation	Size of attaching screw
6696454	Female screw	Counter-clockwise	M10xP1.25-LH

Applicable nylon cord

Cord diameter: Φ 3.0 mm Length: 2 m

Cord diameter: Φ 2.4 mm Length: 4 m

CAUTION

- The case must be securely attached to the cover.
- Check the cover, case and other components for cracks or other damage.
- Check the case and button for wear.
If the wear limit mark on the case is no longer visible or there is a hole in the bottom of the button, change the new parts immediately. (Fig. 16)
- The nylon head must be securely mounted to the unit's gear case.
- If the nylon head does not feed cutting line properly, check that the nylon line and all components are properly installed. Contact HiKOKI Authorized Service Centers if you need assistance.

WARNING

For HiKOKI heads, use only flexible, non-metallic line recommended by the manufacturer. Never use wire or wire ropes. They can break off and become a dangerous projectile.

(2) Installation (Fig. 17)

- ① Press the stopper pin of the gear case in order to lock the cutter holder.
- ② Install nylon head on gear case of tool. The mounting nut is left-hand-threaded. Turn clockwise to loosen/counter-clockwise to tighten.

NOTE

Since the cutter holder cap is not used here, keep it for when a metal blade is used, if so equipped.

(3) Adjusting line length

Set the speed as low as possible and tap the button on the ground. The nylon line will be drawn out about 30 mm with each tap. (Fig. 18)

Also, you can extend the nylon line by hand but the motor must be completely stopped. (Fig. 19)

Adjust the nylon line to the proper length of 110–140 mm before each operation.

4.2 Installing the cutting blade

(1) Installation (Fig.20)

WARNING

- When installing a cutting blade, make sure that there are no cracks or any damage in it and that the cutting edges are facing the correct direction.
- Remove any surface grit from blade installation fittings (cutter holder (A) (B), nut cover, nut). Failure to do so may result in the loosening of nuts.

- The protrusion of the cutter holder (A) may become misaligned with the blade while tightening nut. Before operation, make sure the blade has been properly installed.
- Rotate the blade by hand and make sure there is no rocking or abnormal noise. Rocking may cause abnormal vibrations or result in the loosening of nuts.

CAUTION

- If your unit is equipped with protection cover under a cutting blade, check the blade installation brackets for wear or cracks before operation. If any damage or wear is found, replace it, as it is an article of consumption.
- You have to wear gloves when handling the cutting blade.

NOTE

- When installing cutter holder cap, be sure to set concave side upward.

- ① Press the stopper pin of the gear case in order to lock the cutter holder. Please note that the cutter fixing bolt or nut has left-handed threads, (clockwise to loosen/ counter-clockwise to tighten).
- ② Tighten the fixing bolt or nut with the box wrench.

OPERATION

WARNING

- Do not operate the tool at night or under bad weather conditions when visibility is poor.
- Do not operate the tool when it is raining or right after it has been raining.
- Wear proper footwear to prevent slipping that could cause you to lose your balance and fall.
- Do not use the tool on steep slopes.
When cutting on slopes that are not so steep, cut by moving towards the ridge.
- Take care not to move the cutting attachment too close to your feet.
- Do not raise the cutting attachment above your knee during cutting.
- Do not use the tool where the cutting attachment may come into contact with stones, tree and other obstacles.
- A cutting attachment can injure while it continues to spin after the motor is stopped. When the unit is turned off, make sure the cutting attachment has stopped before the unit is set down.
- Do not use the tool within 15 m of another person. When you work with someone else, maintain a distance of more than 15 m.

1. Insert the battery.

2. Turn on the tool. (Fig. 21-a)

- Press the power switch on the handle, the power goes on and the power lamp on the handle lights green.
- Pressing the power switch a second time turns the power off and the green lamp on the handle goes off.
- While the lever is pulled, the power does not turn ON when the power switch is pressed.

[Auto power off]

When the power is turned on but the lever is not used for 5 seconds, the tool is automatically turned off. To turn the tool on again, press the power switch a second time.

WARNING

Never leave the tool with the power on. This could result in an accident.

3. Mode switch (Fig. 21-b)

The tool is equipped with three modes:

“Power Mode” “Auto Mode” “Eco Mode”.

Each time the mode switch is pressed, the operation mode changes.

The set mode remains set even if the power is turned off.

4. Lever operation and brake (Fig. 22)

To start rotation of the cutting attachment, with the power turned on, pull the lever while pressing the lock lever. When you release the lever, the brake engages in 1–3 seconds, stopping rotation of the cutting attachment. Make sure that the brake operates normally before using the tool.

5. Cutting

- Grip the handle, press the lock lever and pull the lever to start cutting head rotation. (Fig. 22)
- Release the lever when you finish cutting and stop the motor.
- Take a posture that makes it easy to move.

[Using the semi-auto nylon head]

Do not swing the pipe, but use the hips to move the nylon head horizontally from left to right in an arc while going forward and use the right side of the nylon head for cutting grass. (Fig. 23)

[Using the blade]

- Cut grass from right to left, using the left side of the blade to cut. (Fig. 24)
- Slightly tilting the blade to the left while cutting will pile the cut grass to the left, making collection easy.

NOTE

Excessively increasing rotation speed may cause increased blade wear, vibration and noise. It will also result in increased fuel consumption.

WARNING

- Blade thrust may occur when the spinning blade contacts a solid object in the critical area. A dangerous reaction may occur causing the entire unit and operator to be thrust violently. This reaction is called blade thrust. As a result, the operator may lose control of the unit which may cause serious or fatal injury. Blade thrust is more likely to occur in areas where it is difficult to see the material to be cut.
- If cutting attachment should strike against stones or other debris, stop the engine and make sure that the attachment and related parts are undamaged.

6. Carrying the tool

CAUTION

- Remove the storage battery. (Fig. 5)
- Carry the tool holding with hands.
- If the blade is installed, attach the included blade cover.

OPERATIONAL CAUTIONS

This tool incorporates a function to safeguard the electronic components that control the main unit. If an overload occurs during mowing—for example, if the cutting attachment locks up or becomes clogged with vegetation—the function will activate to stop the motor. If this happens, the warning signal (54 in Fig. 25) will flash.

Check the signal status and take appropriate corrective action. (Fig. 25, Table 3)

You can resume use after taking the following corrective action. Take steps to reduce the load imposed on the motor—for example, by reducing the cutting depth. Before clearing vegetation from the cutting attachment, turn off the power and remove the battery from the tool main unit.

Table 3

Power lamp flashing status	Cause	Corrective action
0.5 s on/0.5 s off ■ ■ ■ ■ ■ ■ ■ ■ (slow flashing)	The internal temperature exceeded the preset limit. The tool has stopped. (The motor turns off. The power will shut down automatically after one minute.) [Temperature protection function]	Turn off the power and wait for the device to cool. You can resume use once the device temperature has fallen.
0.1 s on/0.1 s off ■ ■ ■ ■ ■ ■ ■ ■ ■ ■ (rapid flashing)	The tool attachment load exceeded the preset limit. The tool has stopped. (The motor turns off and the lamp flashes for 10 seconds.) [Overload protection function]	Turn off the power and remove the battery. Resolve the cause of the overload. You can resume use after resolving the overload cause.

MAINTENANCE AND INSPECTION

WARNING

Pull out battery before doing any inspection or maintenance.

1. Checking the condition of the cutting attachment

The cutting attachment should be checked regularly. If worn or broken cutting attachment can slip or decrease the efficiency of the motor and burn it out. Replace worn cutting attachment with new ones.

CAUTION

If you use a cutting attachment of which point is worn or broken, it will be dangerous. So replace it with a new one.

2. Inspecting the mounting screws

Regularly inspect all mounting screws and ensure that they are properly tightened. Should any of the screws be loose, retighten them immediately. Failure to do so could result in serious hazard.

3. Maintenance of the motor

The motor unit winding is the very “heart” of the power tool. Exercise due care to ensure the winding does not become damaged and/or wet with oil or water.

4. Inspection of terminals (tool and battery)

Check to make sure that swarf and dust have not collected on the terminals.

On occasion check prior, during and after operation.

CAUTION

Remove any swarf or dust which may have collected on the terminals.

Failure to do so may result in malfunction.

5. Cleaning of the outside

When the grass trimmer / brush cutter is stained, wipe with a soft dry cloth or a cloth moistened with soapy water. Do not use chloric solvents, gasoline or paint thinner, as they melt plastics.

6. Gear case (Fig. 30)

Check gear case or angle gear for grease level about every 50 hours of operation by removing the grease filler plug on the side of gear case.

If no grease can be seen in the screw hole on the sides of the gears, fill the gear case up to 3/4 full with quality lithium based multipurpose grease (sold separately).

CAUTION

- Make sure to remove any dirt or grit when attaching the plug to its original position.
- Before attempting inspection or maintenance of the gear case, make sure the case has cooled.

7. Semi-auto nylon head

Nylon line replacement

- (1) Remove the case by firmly pushing inward the locking tabs. (Fig. 31-a)
- (2) After removing the case, take out the reel and discard the remaining line. (Fig. 31-b)
- (3) Fold the new nylon line unevenly in half. (Fig. 32-a)
Hook the U-shaped end of the nylon line into the groove on the center partition of the reel. (Fig. 32-b)
Wind both halves of the line on the reel in the same direction, keeping each half of the line on its own side of the partition.

NOTE

Do not cross the nylon line when securing the line in the groove. (Fig. 32-d)

- (4) Push each line into the stopper holes, leaving the loose ends approx. 100 mm in length. (Fig. 32-c)
- (5) Align the position of the stopper and eyelet line guide, and then insert the reel through the case.
Release the line from the stopper while holding the reel lightly, and then string the line through the eyelet line guide. (Fig. 33)
- (6) Place the cover over the case so that the locking tabs on the case meet the locking holes of the cover. Then push the case securely until it clicks into place. (Fig. 34)
- (7) The initial cutting line length should be approx. 110–140 mm and should be equal on both sides. (Fig. 35)

8. Blade (Fig. 36)

WARNING

Wear protective gloves when handling or performing maintenance on the blade.

- Use a sharp blade. A dull blade is more likely to snag and thrust.
Replace the fastening nut if it is damaged and hard to tighten.
- When replacing blade, purchase one recommended by HiKOKI, with a 25.4 mm (one inch) fitting hole.
- In the case of a 3 tooth blade, it can be used on either side.
- Use the correct blade for the type of work.
- When replacing blades, use appropriate tools.
- When cutting edges become dull, re-sharpen or file as shown in the illustration. Incorrect sharpening may cause excessive vibration.
- Discard blades that are bent, warped, cracked, broken or damaged in any way.

NOTE

When sharpening blade it is important to maintain an original shape of radius at the base of the tooth to avoid cracking.

9. Storage

Store the power tool and battery in a place in which the temperature is less than 40°C and out of reach of children.

NOTE

Storing Lithium-ion Batteries

Make sure the lithium-ion batteries have been fully charged before storing them.

Prolonged storage (3 months or more) of batteries with a low charge may result in performance deterioration, significantly reducing battery usage time or rendering the batteries incapable of holding a charge.

However, significantly reduced battery usage time may be recovered by repeatedly charging and using the batteries two to five times.

If the battery usage time is extremely short despite repeated charging and use, consider the batteries dead and purchase new batteries.

CAUTION







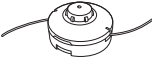

In the operation and maintenance of power tools, the safety regulations and standards prescribed in each country must be observed.

Important notice on the batteries for the HiKOKI cordless power tools

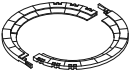
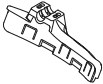
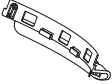
Please always use one of our designated genuine batteries. We cannot guarantee the safety and performance of our cordless power tool when used with batteries other than these designated by us, or when the battery is disassembled and modified (such as disassembly and replacement of cells or other internal parts).

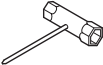
NOTE

Due to HiKOKI's continuing program of research and development, the specifications herein are subject to change without prior notice.

	CG36DC
	(NN)
	1
	1
	1
	1
	1
	1
	1
	1
	1
	1



6684813

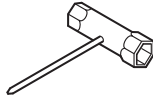

6684764



330787

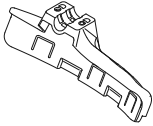

6600528

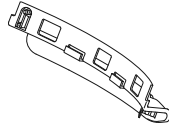

6601356

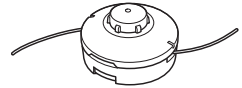

6601432



875769



6698711

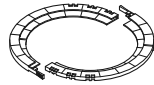

6684768

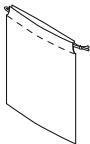

380075

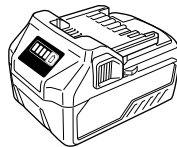

BSL36...18

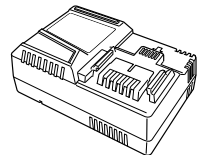

UC18YSL3

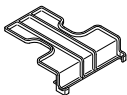

329897

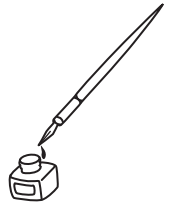

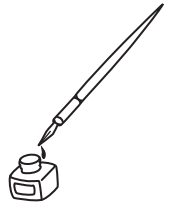

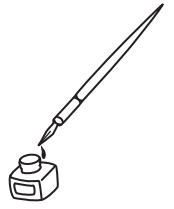

Koki Holdings Co., Ltd.

Shinagawa Intercity Tower A, 15-1, Konan 2-chome,
Minato-ku, Tokyo, Japan