

HiKOKI

充电式电链锯
Cordless Chain Saw

CS 3625DC • CS 3630DC



CS3630DC

保留备用
Keep for future reference



使用说明书
Handling instructions

目次

符号.....	2	电池的拆卸 / 安装法.....	15
详细说明 (图 1).....	3	充电.....	15
电动工具通用安全警告.....	4	USB 设备的充电方法.....	18
充电式电链锯安全警告.....	7	安装 (更换) 锯链.....	19
其他安全警告.....	8	使用前的检查和准备.....	21
锂离子电池使用注意事项.....	11	锯割步骤.....	23
锂离子电池运输.....	12	打磨锯链片.....	27
USB 设备连接器使用注意事项.....	12	维护和检查.....	29
规格.....	13	故障排除.....	32
标准附件.....	14	选择附件.....	33
用途.....	14		

符号

⚠ 警告！

以下所示为机器所用的符号。
在使用前请务必知晓其含义。

	CS3625DC / CS3630DC : 充电式电链锯		请警惕电链锯的反冲力，并避免接触杆尖。
	为降低伤害风险，用户必须阅读使用说明书		务必双手使用电链锯。
	请勿在雨水中或潮湿的环境使用电动工具，或者在下雨时将其置于室外。		请务必穿戴适合脚部、腿部、手部、前臂和头部的防护服。
	请阅读、理解并遵循本手册中和机器上的所有警告和说明。		此链锯仅供经过培训的树木服务操作员使用。未经适当培训而使用本产品，可能导致严重伤害。
	在使用本机时，请始终佩戴眼睛、头部和耳部保护装置。		链油输送速度调整

详细说明 (图 1)

- A: 电池 (另售): 用于驱动装置的电源。
- B: 开关: 以手指启动设备。
- C: 锁定杆: 防止意外触发操作的杆。
- D: 链条制动器: 用于锯链停止或锁定的设备。
- E: 侧盖: 在使用电锯时, 用作导杆、锯链、离合器和链轮的保护盖。
- F: 螺母: 用于固定侧盖的螺母。
- G: 张紧螺钉: 用于调整锯链张力的装置。
- H: 前手柄: 位于或朝向主体前方的支撑手柄。
- I: 后手柄 (上手柄): 位于主体后部的支撑手柄。
- J: 锯链: 用作锯割工具的链条。
- K: 导杆: 锯链的支撑和导引部件。
- L: 尖保险杠: 当接触到树或原木时充当枢轴的装置。
- M: 油箱盖: 用于关闭油箱的盖子。
- N: 油面观察玻璃: 用于观察链油量的窗口。
- O: 挂钩: 用绳索等悬挂本机的工具。
- P: 供油器: 装油的容器。
- Q: 链条盒: 在未使用装置时, 用来盖住导杆和锯链的盒子。
- R: Combi 套筒扳手: 用于拆卸或安装侧盖和张紧锯链的工具。
- S: 充电器 (另售): 用于电池充电。



图 1

警告！

本电链锯 (CS3625DC / CS3630DC) 专门设计用于树木护理和修剪。只有接受过树木护理和修剪相关培训的人员方可使用本电锯。请遵循相关专业组织所给出的文字说明、步骤及建议。否则会引发很高的事故风险。我们建议在锯树时始终使用升降台。绳降技术极其危险，需要专业培训。

操作员必须经过培训，且熟悉安全设备及工作和攀爬技术。务必对操作员和电锯均使用控制设备。

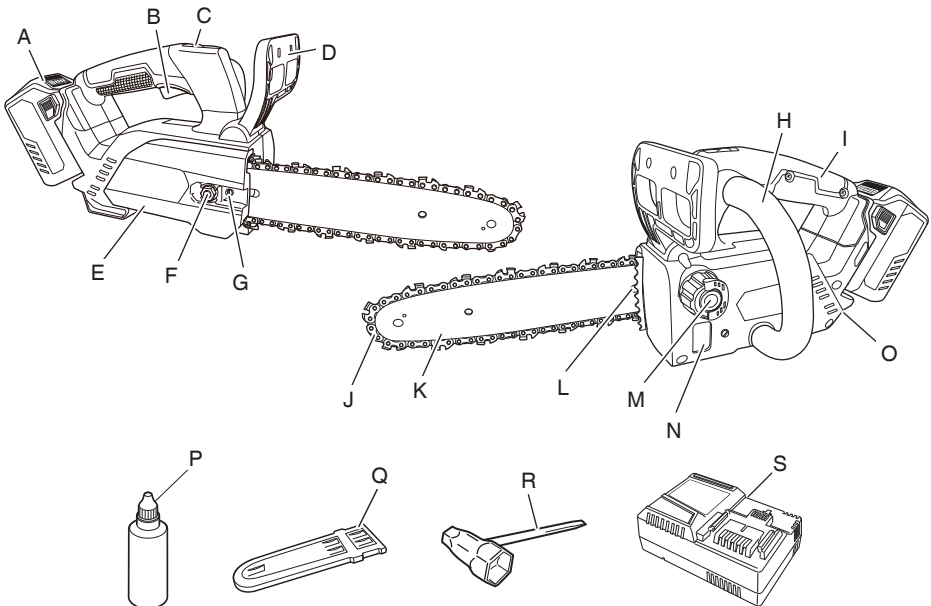
电动工具通用安全警告

⚠ 警告！

阅读电动工具附带的所有安全警告、说明、插图和规格说明。

不遵照以下说明会导致电击、着火和 / 或严重伤害。

保存所有警告和说明书以备查阅。

在所有下列的警告中术语“电动工具”指市电驱动（有线）电动工具或电池驱动（无线）电动工具。

1) 工作场地的安全

- a) 保持工作场地清洁和明亮。
混乱和黑暗的场地会引发事故。
- b) 不要在易爆环境，如有易燃液体、气体或粉尘的环境下操作电动工具。
电动工具产生的火花会点燃粉尘或气体。
- c) 让儿童和旁观者离开后操作电动工具。
注意力不集中会使操作者失去对工具的控制。

2) 电气安全

- a) 电动工具插头必须与插座相配。绝不能以任何方式改装插头。
需接地的电动工具不能使用任何转换插头。
未经改装的插头和相配的插座将减少电击危险。
- b) 避免人体接触接地表面，如管道、散热片和冰箱。
如果你身体接地会增加电击危险。
- c) 不得将电动工具暴露在雨中或潮湿环境中。
水进入电动工具将增加电击危险。
- d) 不得滥用电线。绝不能用电线搬运、拉动电动工具或拔出其插头。使电线远离热源、油、锐边或运动部件。
受损或缠绕的软线会增加电击危险。
- e) 当在户外使用电动工具时，使用适合户外使用的外接软线。
适合户外使用的软线将减少电击危险。
- f) 如果在潮湿环境下操作电动工具是不可避免的，应使用剩余电流动作保护器 (RCD)。
使用 RCD 可减小电击危险。

3) 人身安全

- a) 保持警觉，当操作电动工具时关注所从事的操作并保持清醒。
当你感到疲倦，或在有药物、酒精或治疗反应时，不要操作电动工具。
在操作电动工具时瞬间的疏忽会导致严重人身伤害。
- b) 使用个人防护装置。始终佩戴护目镜。
安全装置，诸如适当条件下使用防尘面具、防滑安全鞋、安全帽、听力防护等装置能减少人身伤害。
- c) 防止意外起动。确保开关在连接电源和 / 或电池盒、拿起或搬运工具时处于关断位置。
手指放在已接通电源的开关上或开关处于接通时插入插头可能会导致危险。
- d) 在电动工具接通之前，拿掉所有调节钥匙或扳手。
遗留在电动工具旋转零件上的扳手或钥匙会导致人身伤害。
- e) 手不要伸展得太长。时刻注意立足点和身体平衡。
这样在意外情况下能很好地控制电动工具。
- f) 着装适当。不要穿宽松衣服或佩戴饰品。让衣服、手套和头发远离运动部件。
宽松衣服、佩饰或长发可能会卷入运动部件中。
- g) 如果提供了与排屑、集尘设备连接用的装置，要确保它们连接完好且使用得当。
使用这些装置可减少尘屑引起的危险。
- h) 请勿因频繁使用工具的熟悉感而掉以轻心，忽视工具的安全性原则。
粗心的行为可能会导致瞬间发生严重伤害。

4) 电动工具使用和注意事项

- a) 不要滥用电动工具，根据用途使用适当的电动工具。
选用适当设计的电动工具会使你工作更有效、更安全。
- b) 如果开关不能接通或关断工具电源，则不能使用该电动工具。
不能用开关来控制的电动工具是危险的且必须进行修理。
- c) 在进行任何调整、更换附件或存放电动工具之前，必须从电源上拔掉插头和 / 或取下电池盒（如果可拆卸）。
这种防护性措施将减少工具意外起动的危险。
- d) 将闲置不用的电动工具贮存在儿童所及范围之外，并且不要让不熟悉电动工具或对这些说明不了解的人操作电动工具。
电动工具在未经培训的用户手中是危险的。
- e) 维护电动工具和附件。检查运动件是否调整到位或卡住，检查零件破损情况和影响电动工具运行的其他状况。如有损坏，电动工具应在使用前修理好。
许多事故由维护不良的电动工具引发。

中文

- f) 保持切削刀具锋利和清洁。
保养良好的有锋利切削刃的刀具不易卡住而且容易控制。
- g) 按照使用说明书，考虑作业条件和进行的作业来使用电动工具、附件和工具的刀头等。
将电动工具用于那些与其用途不符的操作可能会导致危险。
- h) 保持手柄和抓握表面干燥、清洁，远离油和油脂。
如果手柄和抓握表面湿滑，可能导致在发生意外情况时，无法安全操作和控制工具。

5) 电池式工具使用和注意事项

- a) 只用制造商规定的充电器充电。
将适用于某种电池盒的充电器用到其他电池盒时会发生着火危险。
- b) 只使用配有特制电池盒的电动工具。
使用其他电池盒会发生损坏和着火危险。
- c) 当电池盒不用时，将它远离其他金属物体，例如回形针、硬币、钥匙、钉子、螺钉或其他小金属物体，以防一端与另一端连接。
电池端部短路会引起燃烧或火灾。
- d) 在滥用条件下，液体会从电池中溅出；避免接触。如果无意间碰到了，用水冲洗。如果液体碰到了眼睛，还要寻求医疗帮助。
从电池中溅出的液体会发生腐蚀或燃烧。
- e) 请勿使用损坏或改装的电池盒或工具。
损坏或改装的电池可能会引发突发状况，导致火灾、爆炸或受伤。
- f) 请勿将电池盒或工具暴露在有火源或高温环境中。
如果暴露在有火源或 130 度以上高温的环境中，可能引起爆炸。
- g) 请完全按照充电说明进行操作，不要在说明中规定的温度范围外的环境中对电池盒或工具充电。
充电不当或在规定温度范围外的环境中充电可能会导致电池损坏，增加发生火灾的风险。

6) 维修

- a) 将你的电动工具送交专业维修人员，使用同样的备件进行修理。
这样将确保所维修的电动工具的安全性。
- b) 请勿维修已损坏的电池盒。
需由制造商或经授权的服务供应商进行维修。

注意！

不可让儿童和体弱人士靠近工作场所。

应将不使用的工具存放在儿童和体弱人士接触不到的地方。

充电式电链锯安全警告

- 1) 链锯通用安全警告
 - a) 本链锯不适合砍伐树木。将链锯用于与预期不同的操作，可能导致操作员或旁观者严重伤害。
 - b) 操作员必须接受安全攀爬技巧的培训，并使用所有推荐的附加安全装备，如安全带、环形带、皮带、绳索和吊环，以及其他用于操作员和链锯的防坠落系统。在树上的每个作业位置设立一个安全的位置对于避免危险情况至关重要。
 - c) 佩戴护目镜、护耳用具并穿戴适合爬树的头部、前臂、手部、腿部和脚部防护装备。适当的防护设备可减少因飞溅的碎屑或意外接触锯链而带来的受伤事故。
 - d) 仅用于锯割木材。请勿将电链锯用于非指定用途。例如：请勿使用电链锯锯割金属、塑料、砖石或非木材建筑材料。使用电链锯进行非指定用途会导致发生危险。
 - e) 始终以右手握住电锯的后手柄，以左手握住前手柄。在握住电锯时，如果左右手弄反，则会增加受伤风险，故而应杜绝此情况。
 - f) 因锯链可能接触到隐藏的电线，故只能通过绝缘夹紧面来握住电链锯。接触“带电”电线的锯链可能会使电链锯上暴露的金属部件“带电”，并可能使操作员遭受电击。
 - g) 当电链锯正在工作时，请使身体的所有部分均远离锯链。在启动电链锯之前，请确保锯链未接触到任何东西。在操作电链锯时，稍有分心即可能使衣物或身体被锯链缠住。
 - h) 在锯割处于张力下的树枝时，要警惕其弹回。当木纤维中的张力被释放时，承受张力的树枝可能会击中操作员并 / 或使电链锯失去控制。
 - i) 切割细枝时要格外小心。这些细长的东西可能会抓住锯链并向人身上袭来致其失去平衡。
 - j) 清理堵塞材料、存放或维修链锯时，请遵循所有说明。确保开关关闭并将电池组取出。在清除卡住的材料或进行维修时，电链锯的意外启动可能导致严重的人身伤害。
 - k) 携带电链锯时，请握住其前手柄，将电链锯关闭并远离身体。在运输或存储电链锯时，务必装上导杆盖。妥善操作电链锯可减少意外接触移动中的锯链的可能性。
 - l) 按照说明进行润滑、链条张紧以及更换杆和链。对链条张紧或润滑不当会使链条断裂或增加反冲可能。

2) 反冲原因及操作员进行的预防：

当导杆的前端或尖端碰触到某个物体，或者当木材靠近并在锯割处夹住锯链时，可能会发生反冲。(图2)在某些情况下，尖端接触可能会引起突然的反向反应，使导杆向上并朝操作人员方向弹回。



图 2

沿导杆顶部挤压锯链可将导杆迅速推向操作员。

这两种反应都可能使您失去对电锯的控制，从而导致严重的人身伤害。

不要单纯依赖电锯中内置的安全设备。作为电链锯用户，您应该采取若干步骤来使您的锯割作业远离事故或伤害。

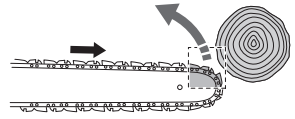
反冲是因不当使用机器和 / 或错误的操作步骤或条件引起的结果，可通过采取以下所述的妥善措施避免：

- a) 紧紧抓住，用拇指和其他手指紧紧握住电链锯手柄，双手放在锯上，身体和手臂的位置要让人能够抵抗反冲力。(图3) 如果采取了妥善的预防措施，操作员是可以控制反冲力的。请勿松开电链锯。
- b) 不要伸得过远。此举有助于防止意外的尖端接触，在意外情况下也可更好地控制电链锯。
- c) 仅使用由生产商所指定的替换导杆和锯链。使用其他更换导杆和锯链可能会使链条断裂及 / 或发生反冲。
- d) 遵循生产商提供的电链锯打磨和维护说明。降低深度计高度会导致反冲增加。



图 3

其他安全警告

1. 工作时应轻松无压力。此外，须保持身体温暖。
2. 当链锯正在工作时，请使身体的所有部位均远离锯链。
3. 在开始工作前，要仔细考虑所涉及的工作步骤和工作内容，以避免发生事故，否则可能发生受伤。
4. 请勿在强风、雨、雪、雾等恶劣天气下或易于发生岩崩或雪崩等区域使用。恶劣天气可能会影响判断，从而因振动而导致灾难。
5. 请勿在恶劣天气下或夜间等能见度较低的情况下使用本机。此外，请勿在雨中或暴露于雨水中的地方使用。站立不稳或失去平衡可能导致事故。
6. 在启动机器前请检查导杆和锯链。
 - 如果导杆或锯链开裂，或者产品被刮伤或弯曲，请勿使用本机。
 - 请检查导杆和锯链是否稳固安装。如果导杆或锯链断裂或移位，则可能发生事故。
7. 在开始工作前，请进行检查，以确保在按下锁定杆前开关未啮合。如果本机未正常工作，请立即停止使用并要求 HIKOKI 授权服务中心进行维修。

8. 按照使用手册妥善安装锯链。

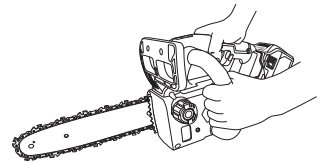
如果安装不当，锯链会从导杆上脱落并可能导致受伤。

9. 切勿取下链锯上所安装的任何安全设备（链条制动器、锁定杆、锯链止动爪等）。

也不要将其改装或固定。

可能会发生受伤。

10. 在以下情况下，关闭本机，同时要确保锯链不再移动：

○ 未使用时。

○ 在移往新的工作地点时。

○ 在检查、调整或更换锯链、导杆、链条盒及其他任何部件时。

○ 在加注链油时。

○ 在除去机体上的灰尘等时。

○ 在工作区域清除障碍物、工作时产生的垃圾或木屑时。

○ 在卸下本机或离开本机时。

○ 或者如果你感觉到危险或预测到风险时。

如果锯链依然在移动，则可能会发生事故。

11. 工作一般应单独完成。在涉及到多人时，请确保彼此之间留有合适间距。

12. 与他人保持15米以上的距离。

此外，在与多人共事时，请保持 15 米的距离或更远。

○ 有可能发生碰撞和其他事故。

○ 事先准备哨声警报等，并为其他工人确定适当的联系方式。

13. 在砍伐立着的树木前，请确保以下事项：

○ 在砍伐前确定安全的疏散地。

○ 事先移除障碍物（如树枝、灌木）。

14. 在使用时，如果机器性能劣化，或者您注意到其发出任何异常声音或振动，请立即关闭并停止使用，并将其送回HiKOKI授权服务中心进行检查或维修。

如果继续使用，则可能发生受伤。

15. 如果本机意外掉落或遭受击打，请仔细检查有无损坏或开裂，并确保其无变形。

如果本机损坏、开裂或变形，则可能导致受伤。

16. 通过车载运输本机时，请将本机固定以防移动。

有发生事故的风险。

17. 在安装了链条盒时请勿开启本机。

可能会发生受伤。

18. 确保材料中无钉子和其他异物。

如果锯链撞击钉子等，则可能导致受伤。

19. 为避免切边时导杆与物料缠绕或锯割时受物料重量的影响，应在锯割位置附近安装支撑台。

如果导杆被缠住，则可能导致受伤。

中文

20. 如果要在使用后运输或存储本机，请取下锯链，或安装链条盒。
如果锯链碰到身体，则可能导致受伤。
21. 精心爱护本机。
 - 为确保安全高效地执行工作，请爱护锯链，以确保其提供最佳锯割性能。
 - 在进行更换锯链或导杆、维护机身、加油等操作时，请遵循使用手册。
22. 要求商店维修本机。
 - 请勿改装本产品，因其已符合适用的安全标准。
 - 请务必委托 HiKOKI 授权服务中心进行所有维修。
试图自行修理本机可能导致事故或受伤。
23. 在未使用本机时，务必将其妥善存储。
排空链油，然后将其保存在儿童无法触及的干燥场所或锁定地点。
24. 如果警告标签看不清、剥落或不清晰，请使用新的警告标签。
有关警告标签的详情，请咨询 HiKOKI 授权服务中心。
25. 在工作时，请遵循当地适用的规章制度。
26. 请确保蓄电池安装牢固。电池松动后，可能脱落并引起事故。
27. 务请在 0°C — 40°C 的温度下进行充电。温度低于 0°C 将会导致充电过度，极其危险。电池不能在高于 40°C 的温度下充电。
最适合于充电的温度是 20 — 25°C 。
28. 不要连续使用充电器。
一次充电完毕后，在15分钟内不要再次使用该充电器对电池充电。
29. 请勿让杂质进入充电式电池连结口内。
30. 切勿拆卸充电式电池与充电器。
31. 切勿使充电式电池短路。电池短路会引起强电流和过热。从而烧坏电池。
32. 请勿将电池丢入火中。电池受热将会爆炸。
33. 充电后电池寿命太短不够使用时，请尽快将电池送往经销店。请勿将用过的电池乱丢。
34. 请勿将异物插入充电器的通风口。若将金属异物或易燃物插入通风口，将会引起触电事故或使充电器受损。
35. 长时间连续使用本机，可能导致机体过热，对马达及开关造成损害。因此，机壳变热时，请让工具休息一段时间。
36. 请确保蓄电池安装牢固。电池松动后，可能脱落并引起事故。
37. 请勿使用工具或电池端子（电池安装部位）明显变形的产品。
否则，安装电池后可能会短路，造成冒烟或起火。
38. 请清除工具端子（电池安装部位）上的削屑和灰尘。
 - 使用前，请确保电池上没有堆积削屑和灰尘。
 - 在使用过程中，请尽量避免工具上的削屑或灰尘掉落到电池上。
 - 暂停不使用工具时或使用后，应将工具存放在不会掉落削屑或灰尘的地方。
否则可能短路，造成冒烟或起火。
39. 请在 -5°C — 40°C 环境下使用本工具及电池。

锂离子电池使用注意事项

为延长使用期限，锂离子电池备配停止输出的保护功能。

若是在使用本产品时发生下列 1 和 3 的情况，即使按下开关，马达也可能停止。这并非故障，而是启动保护功能的结果。

1. 在残留的电池电力即将耗尽时，马达会停止。
在这种情况下，请立即予以充电。
2. 若工具超过负荷，马达亦可能停止。在这种情况下，请松开工具的开关，试着消除超过负荷的原因。之后您就可以再度使用。
3. 若电池在过载工作情况下过热，电池电力可能会中止。
在这种情况下，请停止使用电池，让电池冷却。之后您就可以再度使用。

此外，请留心下列的警告及注意事项。

警告！

为防止发生电池漏电、发热、冒烟、爆炸及提前点燃，请确保留意下列事项。

1. 确保电池上没有堆积削屑及灰尘。
 - 在工作时确定削屑及灰尘没有掉落在电池上。
 - 确定所有工作时掉落在电动工具上的削屑和灰尘没有堆积在电池上。
 - 请勿将未使用的电池存放在曝露于削屑和灰尘的位置。
 - 在存放电池之前，请清除任何可能附着在上面的削屑和灰尘，并请切勿将它与金属零件（螺丝、钉子等）存放在一起。
2. 请勿以钉子等利器刺穿电池、以铁锤敲打、踩踏、丢掷电池，或将其剧烈撞击。
3. 切勿使用明显损坏或变形的电池。
4. 请依规定方式使用电池，切勿移作他用。
5. 如果已过了再充电时间，电池仍无法完成充电，请立即停止继续再充电。
6. 请勿将电池放置于高温或高压处，例如微波炉、烘干机或高压容器内。
7. 在发觉有渗漏或异味时，请勿接近远离火源。
8. 请勿在会产生强烈静电的地方使用。
9. 如有电池渗漏、异味、发热、褪色或变形，或在使用、充电或存放时出现任何异常，请立即将它从装备或电池充电器拆下，并停止使用。
10. 请勿浸泡电池或让任何液体流入电池内部。导电液体进入（如水），可能造成电池损坏，甚至可导致火灾或爆炸。将电池存放在阴凉、干燥的地方，远离易燃物品。必须避免将电池置于腐蚀性气体环境中。

注意！

1. 若电池渗漏出的液体进入您的眼睛，请勿揉搓眼睛，并以自来水等干净清水充分冲洗，立刻送医。
若不加以处理，液体可能会导致眼睛不适。
2. 若液体渗漏至您的皮肤或衣物，请立即以自来水等清水冲洗。
上述情况可能会使皮肤受到刺激。

中文

3. 若初次使用电池时发现生锈、异味、过热、褪色、变形及 / 或其它异常情况时，请勿使用并将该电池退还给供货商或厂商。

警告！

如果有导电异物进入锂电池，可能发生短路，并有发生火灾危险的可能。请在贮存电池时，遵守如下事项。

- 请不要在电池盒内放置导电物体，如钉子、钢丝、铜丝或其他电线。
- 或者将电池装在电动工具中，或者在牢固按入电池盖并挡住通风孔后再存放，以防止短路（图 4）。



图 4

锂离子电池运输

当运输一个锂离子电池，请注意以下预防措施。

警告！

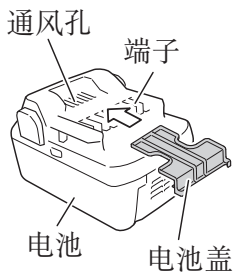
告知运输公司，包装内包含一个锂离子电池，告知该公司其功率输出并且要按照运输公司的指引安排运输。

- 功率输出超过 100Wh 的锂离子电池被视作危险物品运输分类并且需要特别申请程序。（图 5）
- 对于境外运输，您必须遵守国际法以及输入国的规章和条例。



图 5

USB 设备连接器使用注意事项

发生意外情况时，本产品连接的 USB 中保存的数据可能发生损坏或丢失。使用本产品前，请务必备份 USB 设备中的数据。

请注意，如 USB 设备中存储的数据发生损坏、丢失或连接的设备发生损坏，本公司概不负责。

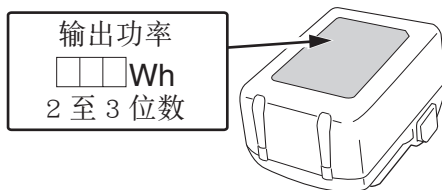
规格

电动工具

型号	CS3625DC	CS3630DC
电压	36V	
锯链	类型：90PX-040X 节距：9.5mm (3/8") 宽度：1.1mm (0.043")	类型：90PX-045X 节距：9.5mm (3/8") 宽度：1.1mm (0.043")
导杆	类型：104MLEA041 尺寸：250mm (最大锯割深度)	类型：124MLEA041 尺寸：300mm (最大锯割深度)
链轮	齿数：6 节距：9.5mm (3/8")	
空载链速	12.6米/秒 (760米/分)	
链油箱容量	70 ml	
电池 *	BSL36A18：锂离子 36V / 18V (2.5Ah / 5.0Ah 10 节)	
重量	3.1kg (安装了 BSL36A18)	3.2kg (安装了 BSL36A18)

* 本工具不适用以下电池 (BSL3660/3626/3620、BSL18 系列等)。





充电器

型式	UC18YSL3
充电电压	14.4V - 18V
重量	0.6kg

标准附件

除了主机 (1 台) 外，产品包中还包括表中所列的附件。

表 1

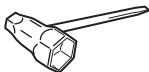
		CS3625DC, CS3630DC
		(XC)
链条盒		1
导杆		1
锯链		1
供油器		1
Combi 套筒扳手		1

用途

- 锯割木材 / 原木
- 修剪花园树木

电池的拆卸 / 安装法

1. 电池的拆卸法

请先紧抓住把手，然后再推压电池插销（2个）以拆下电池（图6）。

注意！

切勿使电池短路。

2. 电池的安装法

插入电池时请注意极性（图6）。



图 6

充电

使用电动工具之前，按下述方法将电池进行充电。

1. 将充电器的电源线连接到插座。

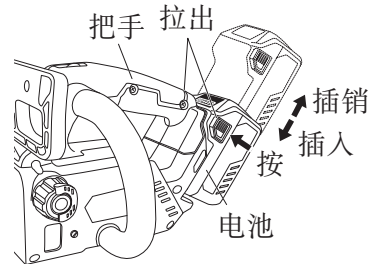
将充电器插头连接到插座时，指示灯闪烁红色（间隔为 1 秒）。

2. 将电池插入充电器。

如图 7 所示，将电池紧紧地插入充电器。

3. 充电

将电池插入充电器后，充电指示灯将呈蓝色闪烁。

电池完全充电后，充电指示灯将持续点亮呈绿色。

（参照第 16 页的表 2）

(1) 充电指示灯的指示状态

根据充电器或可充电电池的情况，充电指示灯的显示如第 16 页的表 2 所示。









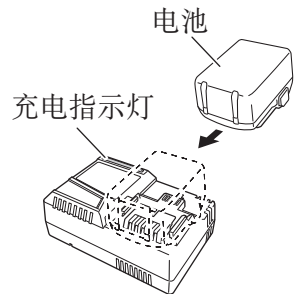

图 7

表 2

充电指示灯的指示状态				
充电指示灯 (红 / 蓝 / 绿 / 紫)	充电前	闪烁 (红)	点亮 0.5 秒钟。不点亮 0.5 秒钟。(熄灭 0.5 秒钟) 	插入电源 *1
	充电时	闪烁 (蓝)	点亮 0.5 秒钟。不点亮 1 秒 钟。(熄灭 1 秒钟) 	电池电量低于 50%
		闪烁 (蓝)	点亮 1 秒钟。不点亮 0.5 秒钟。(熄灭 0.5 秒钟) 	电池电量低于 80%
		点亮 (蓝)	连续点亮 	电池电量高于 80%
	充电 完成	点亮 (绿)	连续点亮  (发出持续蜂鸣声: 约 6 秒)	
	过热 待机	闪烁 (红)	点亮 0.3 秒钟。不点亮 0.3 秒钟。(熄灭 0.3 秒钟) 	电池过热。无法充 电(电池冷却后将 开始充电) *2
	无法 充电	闪动 (紫色)	点亮 0.1 秒钟。不点亮 0.1 秒钟。(熄灭 0.1 秒钟)  (发出断续蜂鸣声: 约 2 秒)	电池或充电器故障 *3

*1 如果即便在已安装充电器后红灯仍然继续闪烁，则检查以确认电池已经完全插入。

*2 尽管电池留在原位，一旦其已冷却，充电仍将会开始；但最佳操作还是取下电池，并在充电前使其在阴凉、通风良好处进行冷却。

*3

○ 完全插入电池。

○ 检查以确认电池槽或端子处无异物卡住。

< 如充电时间很长 >

○ 在极低环境温度中，充电将花费更长时间。在温暖位置（如室内）对电池进行充电。

○ 请勿堵塞通风口。否则内部将会过热，从而降低充电器的性能。

○ 如果冷却风扇不运行，请联系 HiKOKI 授权的维修中心进行维修。

(2) 可充电电池温度和充电时间相关资料
温度和充电时间如表 3 所示。

表 3

电池		充电器	UC18YSL3	
电池类型			锂离子	
充电电压			14.4 – 18V	
可对电池进行充电的温度			0°C – 50°C	
电池容量的充电时间，约为 (在20°C时)		1.5Ah	15 分钟	
		2.0Ah	20 分钟	
		2.5Ah	25 分钟	
		3.0Ah	20 分钟 (BSL1430C, BSL1830C: 30 分钟)	
		4.0Ah	26 分钟 (BSL1840M: 40 分钟)	
		5.0Ah	32 分钟	
		6.0Ah	38 分钟	
		8.0Ah	52 分钟	
	多电压系列		1.5Ah (×2 机)	20 分钟
			2.5Ah (×2 机)	32 分钟
		4.0Ah (×2 机)	52 分钟	
电池数量			4 – 10	
USB 充电电压			5V	
USB 充电电流			2A	
重量			0.6kg	

注：

充电时间可能会因环境温度和电源电压而异。

4. 从电源插座拔下充电器的电源线。

5. 握紧充电器并取出电池。

注：

充电后，先将电池从充电器中取出，然后妥善保存。

关于新电池的放电

新电池内部的化学物质未被激活或电池长时间不使用时，初次或第二次使用时需要将其放电至较低电量。这只是暂时现象，将电池充电 2 – 3 次即可恢复为充电所需的正常时间。

较长时间保持电池性能的方法

(1) 在电池电力完全耗尽之前进行充电。

感到电动工具的能力变弱时，请停止使用并给电池充电。若您继续使用电动工具并耗尽电力，电池可能会损坏或其使用寿命缩短。

(2) 避免在高温环境中充电。

使用后可充电电池的温度将迅速升高。若使用后立即对这种电池进行充电，其内部化学物质会劣化，电池使用寿命将缩短。请稍等片刻，待电池冷却后再进行充电。

注意！

○ 如果电池长时间放置在阳光直射的地方或者刚刚使用完毕时，电池会变热。如果此时对电池充电，充电器的充电指示灯会点亮 0.3 秒钟，然后熄灭 0.3 秒钟（熄灭 0.3 秒钟）。此时请等待电池冷却后再开始充电。

○ 充电指示灯闪动（闪动间隔为 0.2 秒钟）时，请检查充电器的电池连接器内是否有异物并加以清除。如没有异物，则可能是电池或充电器发生了故障。请将其送往当地授权服务中心。

USB 设备的充电方法

警告！

○ 使用之前请检查 USB 连接线缆是否有破损或损坏。

使用有破损或损坏的 USB 线缆可能会导致冒烟或着火。

○ 不使用产品时，请用橡胶盖封好 USB 端口。

USB 端口中落入灰尘等可能会导致冒烟或着火。

注：

○ USB 充电过程中，可能会有偶尔暂停。

○ USB 设备未充电时，请将充电器上拔下 USB 设备。

否则不仅会减少 USB 设备的电池寿命，还会导致意外事故。

○ 根据设备类型，可能无法对部分 USB 设备进行充电。

(1) 选择充电方式

根据所选的充电方式，将电池插入充电器或连接电源线插入插座。

○ 将 USB 设备插入插座进行充电

（图 8-a）。

○ 将 USB 设备和电池插入插座进行充电。

（图 8-b）



图 8

(2) 连接 USB 线缆。(图 9)

拔下橡胶盖并将市售的 USB 线缆（匹配充电的设备）紧紧插入 USB 端口。

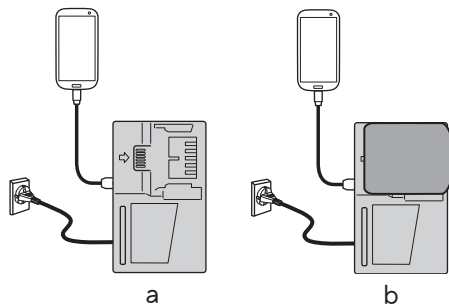

图 9

(3) 充电完成时

- 检查 USB 设备以检验充电状态。
- 从插座中拔下电源线。(图 10)
- 用橡胶盖盖住 USB 端口。

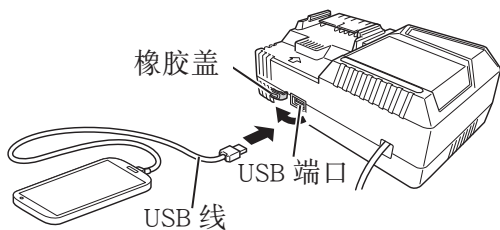

图 10

安装（更换）锯链

警告！

- 为了防止发生事故，请务必关闭本机，并取出电池。
- 请勿在除“规格”中所指定的情况外使用锯链或导杆。

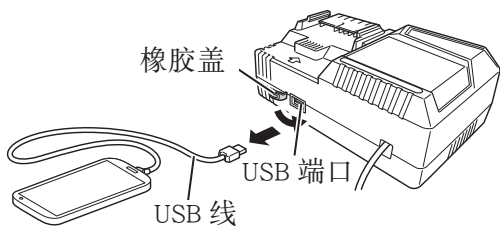
注意！

佩戴厚手套，并务必小心，以免被锯链所伤。

注：

- 在取下锯链时，除去油喷出口、油孔和导杆凹槽中的锯屑。如果锯屑堆集，则可能引发本机故障。
- 根据规格使用正确型号的锯链。如果安装型号有误的导杆，则可能因锯链脱落而导致受伤。



图 11

1. 取下侧盖 (图 11)

转动螺母并取下侧盖。

2. 取下锯链和导杆 (图 12)

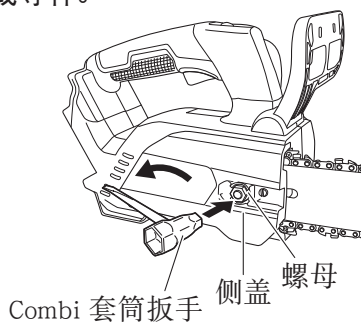
朝“-”方向旋转张紧螺钉，使锯链稍有松弛，然后从链轮上取下。沿箭头所示方向与导杆一起取下。



图 12

3. 将新的锯链装入链轮中 (图 13)

- ① 从导杆尖端安装新锯链。确保锯链的朝向使锯片朝向链轮下的图示方向。
- ② 将螺栓和紧链器旋钮插入导杆上的孔中，与此同时要握住链条和导杆尖端。将锯链端部装入链轮，将导杆安装至电锯主体。

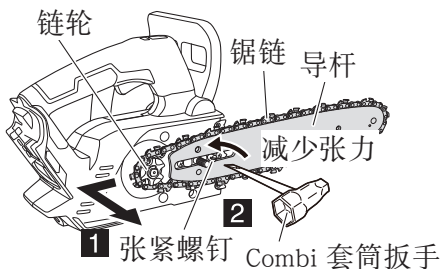

图 13

4. 安装侧盖 (图 14)

- ① 将支耳插入电锯主体上的孔中，安装侧盖。确保锯链未从导杆上松动。
- ② 转动螺母一次，将其暂时固定。在重新安装侧盖之前，请除去其上面的任何污垢。

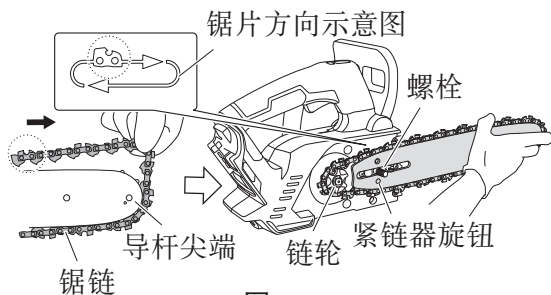

图 14

5. 调整锯链张力 (图 15)

- 在抬起导杆尖端的同时，转动张紧螺钉以调整锯链张力。
- 将张紧螺钉转至“+”可增加锯链张力，转至“-”可减少张力。

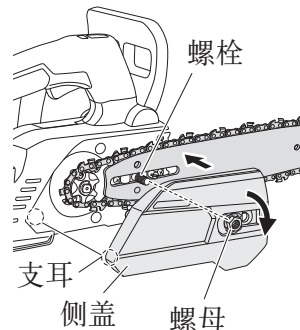

图 15

6. 检查锯链张力 (图 16)

将锯链靠近导杆中心处稍微抬起，调整锯链张力，使锯链传动杆与导杆之间的间隙为 0.5 至 1mm。

7. 固定螺母 (图 17)

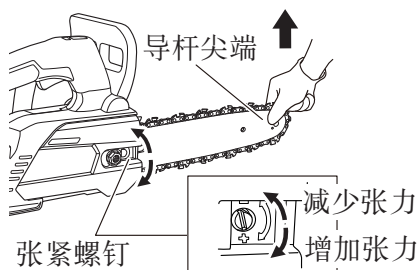
调整完成时，抬起导杆，然后将螺母完全拧紧。

警告！

在调整锯链张力后，确保将螺母完全拧紧。

如若松动，则可能导致受伤。



图 16



图 17

使用前的检查和准备

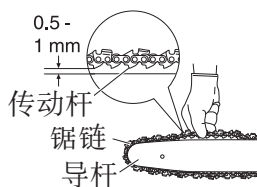
在使用前，请进行以下检查和准备。

警告！

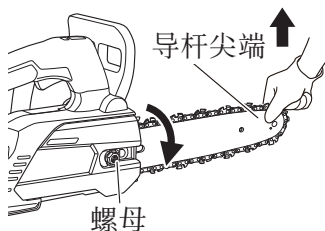
- 为了防止发生事故，务必执行步骤 1 至 3，以确保将电池从机体上取下。
- 不要将锁定杆固定在滑动位置。
如果开关意外啮合，那么本机可能意外启动，从而导致受伤。

1. 确保开关关闭

- 如果在未知开关是否啮合的情况下插入电池，则本机可能会意外启动，从而导致事故发生。
- 在锁定杆处于滑动位置的同时开关啮合时，本机开启；在松开开关时，本机关闭。

2. 检查锯链张力

- 如果锯链张力不当，则有可能导致锯链或导杆损坏或故障。请参阅步骤 5 至 7 “安装（更换）锯链，”，确保设定合适的张力。
- 锯链尚新时尤为有弹性，因此请进行定期检查，并按需调整。
- 同时检查螺母是否牢固拧紧。

3. 检查链油

- 本机在交付时里面并无链油。在使用前，请确保油箱中加满所提供的链油。（图 18）
- 在工作期间请定期查看油面观察玻璃，必要时加油补充。
- 如果所提供的链油耗尽，请使用另售的 HIKOKI 链油或市售的等类链油。
- 链油自动润滑。

自动润滑的流量在工厂预设为最大值。

若要减缓流量，请将油面观察玻璃右侧的油泵调节器朝顺时针方向转动。（图 19）

注：

- 油箱容量约为 70 ml。
在补充链油时，请确保无油从油箱漏出或溢出。
- 我们建议您储备一些链油。
如果在无链油的情况下继续工作，则可能会导致锯链烧毁或电机故障。
- 请小心以避免灰尘或其他异物进入油箱中。
如果灰尘或其他异物混入油箱，则可能导致本机故障。
- 基于本机结构，油箱中剩下的链油可能会漏出。虽然这并非故障，但其会污染存储地点，因此应小心避免。
在存储、清空油箱中的油时，请在主体下方放置可吸收漏油的物件。
- 每工作约 10 分钟后，应补充链油。（* 因砍伐使用条件而异）



图 18



图 19

4. 安装电池（第 15 页的图 6）

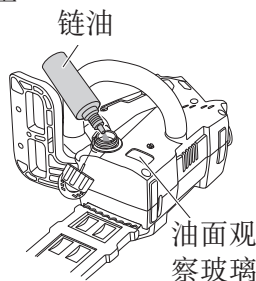
如第 15 页的图 6 所示，稳稳推动至其卡入到位。

注意！

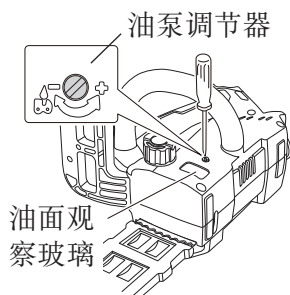
牢固安装电池。

如果电池安装不牢固，其可能会脱落并导致受伤。

5. 检查链条制动器操作（图 20）

警告！

○ 虽然链条制动器属急停设备，但是也并非完全可靠。请小心操作，以避免反冲风险。

○ 链条制动器预期用于紧急情况以及在启动时。请勿随意使用。

○ 为避免由于木屑等堆积而影响链条制动器的限制性运动，请定期清洁。

○ 链条制动器是确保安全使用的重要部件。

如对链条制动器操作存在任何担忧，请要求 HIKOKI 授权服务中心进行维修。



图 20

链条制动器为紧急停止设备，其可在本机受到反冲力等时使锯链停止，从而降低风险。

（请参阅“反冲原因及操作员进行的预防”）

按箭头所示方向推链条制动器，可施加链条制动器并停止锯链（图 20）。若要松开链条制动器，请松开开关并拉回链条制动器。

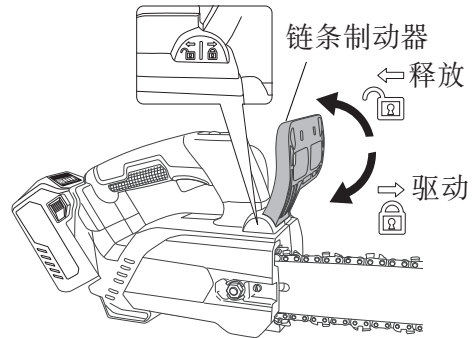
注意！

链条制动器仅在电源开启时发挥作用。在附近无人或阻碍物的地方检查链条制动器功能。

① 在滑动锁定杆的同时按下开关。

② 一旦锯链开始转动，即朝锯链方向将链条制动器朝前推。

③ 如果锯链停止，则链条制动器按其应有功能运行。若要松开制动器，请松开开关并拉回链条制动器。

6. 检查链油释放（图 21）

○ 在开启本机时，链油会自动润滑锯链和导杆。

○ 在本机开启后 2 至 3 分钟，如果油看起来并未喷出，请检查油喷出口是否有锯屑堆积。

（请参阅“清洁链油喷出口。”）

（请参阅“检查链油。”）



图 21

7. 使用挂钩

通过将绳索等系在挂钩上，可以悬挂本机。

警告！

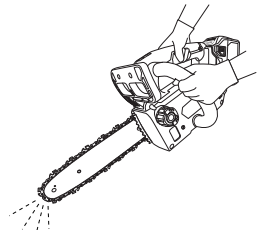
使用挂钩时，确保本机牢固悬挂，以避免掉落风险。

如果本机掉落，可能会发生事故。



图 22

锯割步骤

警告！

- 在树上作业时，在眼部、头部、手部、腿部和臂部佩戴合适的防护装备并穿上防滑安全鞋。
- 在操作前，请确保链条制动器可正常工作。（第 8 页的图 3）
- 在使用过程中，以双手紧紧抓住手柄。
- 从底部锯割木材时，请确保锯链未撞击到木材。
如果将本机向后推，则可能导致受伤。
- 在工作期间休息或工作后，务必关闭本机，并将电池从机体上取下。

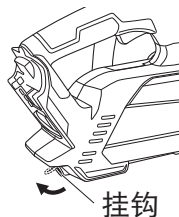
始终注意工作场所和周边区域的情况，确保没有可引起受伤、事故或故障的物体；如有，请事先移除。

特别是在搭建作业立足处时，请确保没有不稳定或任何可能被绊倒的物体。

① 确保将本机关闭

如果在未知开关是否啮合的情况下插入电池，则本机可能会意外启动，从而导致事故发生。

② 安装电池（第 15 页的图 6）

如第 15 页的图 6 所示，稳稳推动至其卡入到位。

③ 接通开关

在确保锯链未接触到木材的同时，接通开关，然后在锯链速度变快时开始锯割。

注意！

- 在开启本机时，请确保锯链未接触到木材或其他任何东西。
- 在使用过程中，请务必小心，以确保锯链不要接触到其他材料或物体。特别是在完成锯割时，请务必小心，以确保其不要接触到地面。

注：

可早点儿给油箱加油，以防本机油耗尽。

1. 开关操作

在滑动锁定杆的同时开关啮合时，锯链转动（图 23）。除非正在滑动锁定杆，否则开关不会啮合。在开关啮合后，只要将其按下，锯链即会继续转动。松开开关时，会施加制动使锯链停止转动。



图 23

2. 一般锯割步骤

- (1) 开启电源，同时使电锯稍微远离待锯割的木材。仅在本机到达全速后开始锯割。
- (2) 在锯割细长的木材时，将导杆的基底部分压在木材上，然后如图 24 所示往下锯割。
- (3) 在锯割较厚的木材时，将本机前部的尖状物压在木材上，然后将尖状物作为支点，以杠杆动作进行锯割，具体如图 25 所示。
- (4) 在水平锯割木材时，将机体向右转，使导杆位于下方，并以左手握住前手柄上侧。水平握住导杆，将位于机体前部的尖状物置于腰部。将尖状物作为支点，通过将后手柄向右转动以切入木头。（图 26）
- (5) 当从底部切入木头时，使导杆上部稍微接触木材。（图 27）
- (6) 同时要仔细学习操作说明，确保在使用前知晓电链锯操作的实用说明，或者至少要通过在锯架上锯割各种长度的原木来实际练习如何使用电链锯。
- (7) 在锯割原木或不支持的木材时，在锯割过程中请使用锯架或其他妥善方式将其固定并妥善支撑。

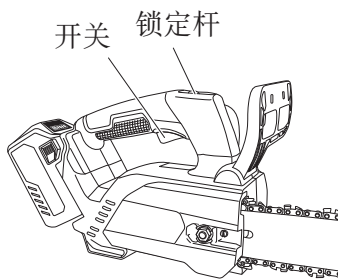

图 24



图 25

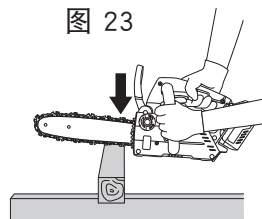

图 26

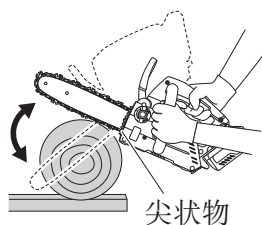

图 27

注意！

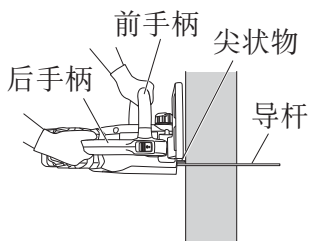
- 从底部锯割木材时，如果链条强烈撞击木材，则存在机体可能朝用户回推的危险。
- 从底部开始锯割木材时，请勿一路锯割至底，否则在锯割完成时，会有导杆飞出失控的危险。
- 始终要防止操作中的电链锯接触地面或铁丝网。

3. 树枝砍伐

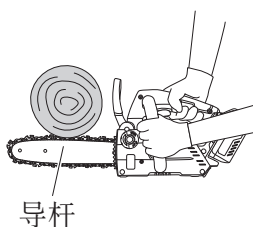
(1) 从立着的树木上砍下树枝：

粗大的树枝应先从远离树干的某点处砍伐。

首先从下面砍入三分之一，然后从上面将树枝砍下。最后，把树枝的剩下部分甚至连同树干一同砍掉。（图 28）



图 28

注意！

- 始终要小心以避免树枝掉落。
- 始终要警惕电链锯回弹。

(2) 从倒下的树上砍下树枝：

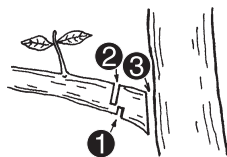
首先砍下 未接触地面的树枝，然后再砍下 接触地面的那些。在砍下接触地面的粗大树枝时，首先从上方砍入约一半，然后从下方将树枝砍断。（图 29）



图 29

注意！

- 在砍伐接触地面的树枝时，请注意不要让导杆受压力束缚。
- 在最后锯割阶段，请当心原木会突然滚动。

4. 原木锯割

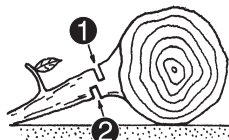
在锯割位置如图 30 所示的原木时，首先从下方砍入约三分之一，然后从上方砍到底。如图 31 所示，在锯割跨越空心的原木时，首先从上方砍入约三分之二，然后从下方往上锯割。



图 30



图 31

注意！

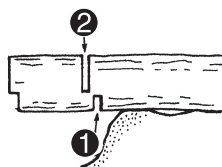
- 确保导杆在原木中未受压力束缚。
- 在倾斜的地面上工作时，一定要站在原木的上坡一侧。如果站在下坡侧，那么切断 的原木可能会滚向您身边。

5. 锯割平放的原木

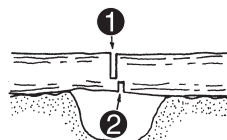
确保原木稳定。

将尖状物朝原木推。以尖状物作为支点，以提起手柄便于锯割。（图 32）

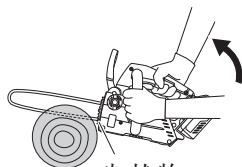

尖状物

图 32

6. 锯割两端有支撑的原木

首先从顶部开始锯到大约三分之一的深度，然后从下面锯至完成锯割。

如果试图从顶部一直锯到底，则导杆可能会卡在锯槽中。（图 33）



图 33

砍伐作业的预防注意事项

适用于大规模作业或不停机作业

本工具配有过热保护电路，以保护控制可充电电池的电子零件。在持续使用过程中，或在压力对工具产生的高负荷下运行时，工具温度会升高，并最终触发过热保护电路，使工具关闭。

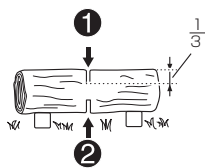
此时，请让工具冷却一段时间。当温度降下来时，即可再次使用工具。在持续工作期间，如果必须更换可充电电池，请让工具休息约 15 分钟。

电链锯的夹紧 / 推力

始终牢牢抓紧电链锯。

此外，不要强行对电链锯施加大于必需的力。在锯割过程中，在电链锯上施加多余的力并不会加快锯割速度。这样反而会拉伤电机、损害性能、损坏或导致电机或导杆故障。在使用装置时，应控制在锯链处于合理速度下的范围内。

特别是，当因用力过大而使锯链停止（卡住）时，可能会导致人员受伤或装置故障。

锯链止动爪

- 锯链止动爪位于链条正下方的动力头处，可进一步防止链条在断裂时撞击电链锯用户的可能性。
- 当锯链被切断时，请以新的更换，具体请参阅“安装（更换）锯链”。

8. 剩余电池电量指示灯

可以按下剩余电池电量指示灯开关点亮指示灯，查看电池的剩余电量。（图 34，表 4）

按住剩余电池电量指示灯开关约 3 秒后，指示灯将熄灭。

环境温度和电池状态可能会对剩余电池电量产生轻微的影响，因此，建议您仅将指示灯作为参考。

剩余电池
电量指示灯

剩余电池电量
指示灯开关









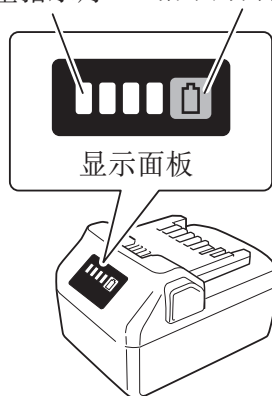

图 34

表 4

指示灯状态	电池剩余电量
	点亮； 电池剩余电量超过 75%。
	点亮； 电池剩余电量为 50%—75%。
	点亮； 电池剩余电量为 25%—50%。
	点亮； 电池剩余电量不到 25%。
	闪烁； 电池剩余电量即将耗尽。请尽快对电池进行充电。
	闪烁； 因高温暂停输出从电动工具中取下电池，让电池完全冷却。
	闪烁； 因失败或故障暂停输出。电池可能出现故障，请与经销商联系。

注：

请勿强烈撞击或破坏显示面板。否则可能会导致故障。

打磨锯链片

警告！

为防止发生事故，请始终关闭开关，并将电池从主体上取下。

注意！

在操作锯链时，请始终佩戴厚手套。

注：

在锯链安装于主体上时，打磨锯链并调整导杆中间位置的深度计。
当锯链的锋利度下降时，电机和机体各部分的负担加重，从而导致性能下降。
为保持机器的最佳性能，需要经常进行维护以保持锯链锋利。

1. 锯片打磨

使用直径为 4 mm 的圆锉。

圆锉应紧贴锯链片，使其直径的四分之一延伸至锯链片顶部，具体如图 35 所示。

将圆锉与导杆之间的角度保持为 30° ，藉此打磨锯链片，具体如图 36 所示。

将圆锉轻轻地朝握把方向推，藉此将锯链片锉平。

在回拉锉刀时，确保圆锉未碰触到锯链。

确保以相同角度锉所有锯片，否则会有损工具的锯割效率。正确打磨锯片的合适角度如图 37 所示。

(圆锉为另售。)



图 35



图 37

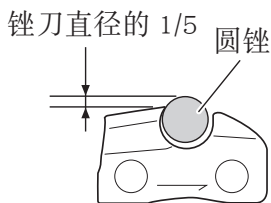

图 37

2. 调整深度计

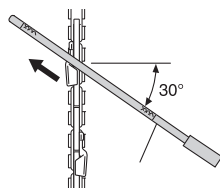
警告！

○ 不要对保险杠扎带和保险杠传动连杆的顶部部位进行打磨，也不要造成上述部位的形状变形。(图 38)

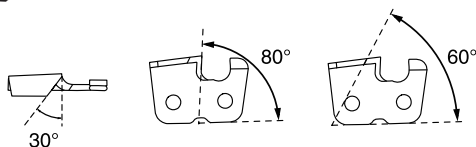
○ 深度计的调整必须符合预定的尺寸和形状，否则可能会增加反冲的风险，从而造成伤害。



图 38

深度计应以相同的方式排列，因为其用于刀具嵌入木材处的深度调整。

在打磨锯链时，务必要每两到三次检查深度计。(图 39)

将深度计连接器放在锯链上，使仪器在凹槽处可见，然后使用扁锉将突出于深度计连接器的部分锉成斜面。

(图 40) (深度计连接器和扁锉为另售。)

用锉刀将深度计锉平后，将深度计的正面磨圆。(图 41)

将锯链打磨后，将其放入链油中以洗掉锉屑。

如果锉屑未清理干净，则锯链和导杆将在使用时快速磨损。

当用圆锉修整时，也可以使用深度计连接器。(图 42)



图 39



图 40

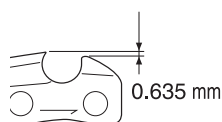

图 41

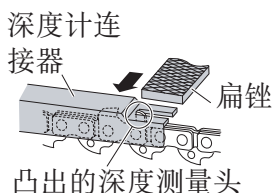

图 42

维护和检查

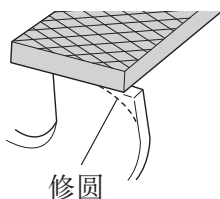
在操作后存储本机时，请对各部分进行检查和维护。

警告！

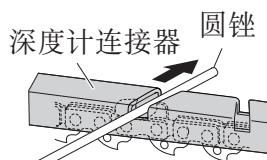
在维护和检查期间，请务必关闭本机，并将电池从主体上取下。

注意！

在操作锯链时，请始终佩戴厚手套。

1. 检查锯链

- 偶尔检查锯链。如果发现任何异常，请以新的更换，具体请参阅“安装（更换）锯链”。
- 检查链条张力，并检查其是否正确紧固。
- 当本机变钝时，请停止使用并进行打磨，具体可参阅“打磨锯链片”。
- 在使用后，请以油仔细润滑锯链和导杆，以防生锈。

注：

在清洁侧盖、链轮、链油喷出口和导杆时，请参见步骤“安装（更换）锯链”并取下锯链。

2. 清洁侧盖和链轮（图 43）

清洁并除去零件中残留的木屑和灰尘。

3. 清洁链油喷出口（图 44）

在清洁链油喷出口时，请取下侧盖和导杆。

4. 清洁导杆（图 45）

当锯屑和类似东西堵住导杆凹槽或油喷出口时，油可能无法流动，从而导致机器故障。

在使用后及更换锯链时，请取下导杆，并将凹槽中堵塞的锯屑清理干净。（请参阅“安装（更换）锯链。”）

5. 清洁链条制动器（图 46）

用刷子将锯身空隙中的木屑清理干净。



图 43



图 44

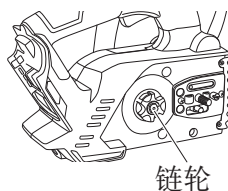
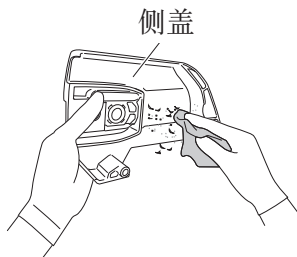

图 45

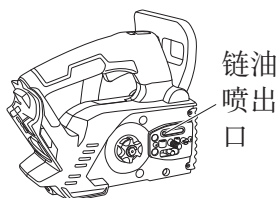

图 46

6. 检查锯链止动爪 (图 47)

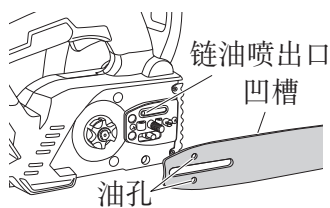
锯链止动爪的设计是为了保护操作人员在锯链松动或被切断时免受击打。

锯链止动爪集成于侧盖中。请检查以确认锯链止动爪未损坏。

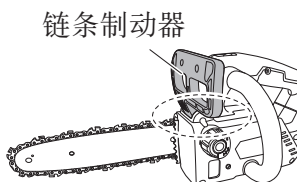

图 47

7. 检查安装螺钉

定期检查所有安装螺钉,确保其被妥善拧紧。

如果发现任何螺钉松动,请立即将其重新拧紧。否则可能导致严重危险。

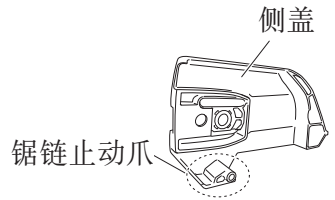
8. 维护电机

电机单元绕组是电动工具的“心脏”。

请小心操作,确保绕组不被损坏和/或被油或水浸湿。

9. 清洁电池安装舱和电池 (图 48)

警告!

为防止吸入灰尘或刺激眼睛,使用吹风枪清洁时,请佩戴好安全护目镜和防尘面罩。

用刷子或吹风枪除净木屑和灰尘,保持电锯清洁。



图 48

注:

- 在使用过程中允许木屑和灰尘积聚可能会引起电池掉落或发生其他事故。木屑和灰尘积聚还可导致功能异常,如电池与端子之间接触不良。
- 在清洁后,请进行检查,确保可轻松取下电池并将其重新安装到工具主体上。

10. 清洁外部

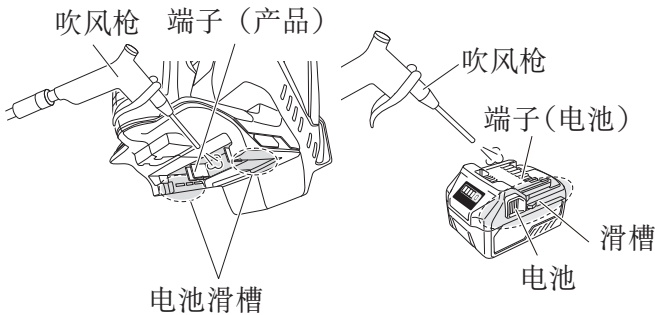
电动工具脏污后,请用干软布或沾有肥皂水的布擦拭。请勿使用氯溶剂、汽油或油漆稀释剂,因为它们会使塑料融化。

11. 存储

- 彻底清洁所有零件。在金属部件上涂上一层薄薄的缓蚀剂。
- 在存储前，务必要修理好损坏部位。
- 在存储本机时，请对各零件进行清洁和维护，并在导杆上安装链条盒。
- 将电动工具和电池存储在温度低于 40°C 且儿童无法触及之处。

注：

存放锂离子电池

存放锂离子电池前，确保其已充满电。

电池在低电量的状态下长时间存放（3 个月或更长），可能会导致电池性能劣化，使用时间明显减少或无法进行充电。

但是，即使是使用时间明显减少的电池，通过反复充电和使用 2 ~ 5 次，有时也可恢复使用时间。

若反复充电和使用后电池的使用时间仍非常短，请认作为电池已达到了使用寿命并更换新的电池。

12. 服务与维修

所有优质电动工具都将因正常使用磨损进行维修或更换部件。为确保维修或更换的部件仅为 HiKOKI 授权的更换部件，所有维修及修理工作仅限由 HiKOKI 授权的维修中心进行。

注意！

在操作和维修电动工具时，必须遵守贵国制定的安全的有关规则和标准。

关于 HiKOKI 牌无线电动工具的重要通知：

请确保始终使用我们指定的正版电池。如果使用我们指定以外的电池，或对电池进行拆卸和改动（例如拆卸和更换电池组件或其他内部部件），那么我们无法保证我们无线电动工具的安全性和使用性能。

故障排除

警告！

- 为避免意外启动造成人身伤害，在进行任何调整之前，请关闭开关并从电源上拔下插头或从主体中取出电池。
- 所有电气或机械维修仅可由有资格的维修技术人员进行。联系 HiKOKI 授权服务中心。

现象	可能的原因	解决办法
电机发出声音，但锯链 ... ○ 不动 ○ 不能自由移动	链条制动器可能已启用。	将链条制动器朝身前拉以释放。
	锯链张力过大。	检查锯链张力，如果过紧，请松开。
	锯链从链轮中脱出。	检查锯链是否妥善啮合在链轮中。
	侧盖中 ... → 锯屑堵塞 → 异物积聚	清洁侧盖。
	导杆凹槽中 ... → 锯屑堵塞 → 油不流动	清洁导杆凹槽和油孔。 确保油箱中有油，需要时进行补充。
不锋利	锯链 ... → 磨损或锯片断裂 → 生锈	打磨锯链。 如果磨损或断裂严重，请以新的锯链更换。
	锯链方向颠倒，	按正确方向重新安装。
	锯链张力太松。	检查锯链张力，如果太松则紧固。
链油 ○ 流动缓慢 ○ 不出油 (卡顿)	油箱中链油缺乏。	补充链油。
	链油喷出口堵塞。	清洁链油喷出口。
电池无法安装。	试图在工具上安装非指定电池。	请安装多伏型电池。

选择附件

根据特定作业选择适合的附件。
有关详细信息请联系 HiKOKI 授权服务中心。



90PX-040X (3/8 × 10")

90PX-045X (3/8 × 12")



104MLEA041 (10")

124MLEA041 (12")

10" : 379896

12" : 380067

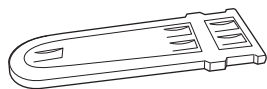

10" : 379898

12" : 377207

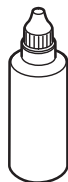

957681



6698688

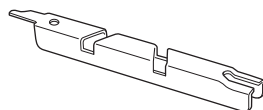

6697724

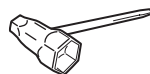

6698582

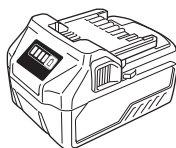

BSL36A18

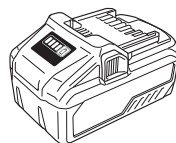

BSL36B18

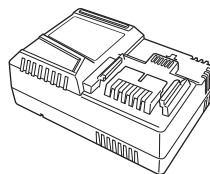

UC18YSL3
(14.4V - 18V)

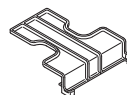

329897







CONTENTS

SYMBOLS	34
WHAT IS WHAT? (Fig. 1)	35
GENERAL POWER TOOL SAFETY WARNINGS	36
CORDLESS CHAIN SAW SAFETY WARNINGS	39
ADDITIONAL SAFETY WARNINGS	41
CAUTION ON LITHIUM-ION BATTERY	43
REGARDING LITHIUM-ION BATTERY TRANSPORTATION	45
USB DEVICE CONNECTION PRECAUTIONS	45
SPECIFICATIONS	46
STANDARD ACCESSORIES	47
APPLICATIONS.....	47
BATTERY REMOVAL/INSTALLATION	48
CHARGING	48
HOW TO RECHARGE USB DEVICE	51
INSTALLING (REPLACING) SAW CHAIN.....	52
INSPECTION AND PREPARATION PRIOR TO USE.....	54
CUTTING PROCEDURES.....	57
SHARPENING OF THE CHAIN BLADE	61
MAINTENANCE AND INSPECTION	63
TROUBLESHOOTING GUIDE	66
SELECTING ACCESSORIES.....	67

SYMBOLS

WARNING

The following show symbols used for the machine. Be sure that you understand their meaning before use.

	CS3625DC / CS3630DC: Cordless Chain Saw		Beware of chain saw kickback and avoid contact with bar tip.
	To reduce the risk of injury, user must read instruction manual.		Always use chain saw two-handed.
	Do not use a power tool in the rain and moisture or leave it outdoors when it is raining.		It is important that you wear the protective clothing for feet, legs, hands, fore-arms and head.
	Read, understand and follow all warnings and instructions in this manual and on the unit.		This chain saw is for use by trained tree service operator only. Use without proper training can result in severe injuries.
	Always wear eye, head and ear protectors when using this unit.		Chain oil delivery rate adjustment

WHAT IS WHAT? (Fig. 1)

- A: Battery (sold separately): Power source to drive the unit.
- B: Switch: Device activated by the finger.
- C: Lock-off lever: Lever that prevents the accidental operation of the trigger.
- D: Chain brake: Device for stopping or locking the saw chain.
- E: Side cover: Protective cover to the guide bar, saw chain, clutch and sprocket when the chain saw is in use.
- F: Nut: Nut for securing side cover.
- G: Tensioning screw: Device for adjusting tension of saw chain.
- H: Front handle: Support handle located at or towards the front of the main body.
- I: Rear handle (Top handle): Support handle located on the rear of the main body.
- J: Saw chain: Chain, serving as a cutting tool.
- K: Guide bar: The part that supports and guides the saw chain.
- L: Spiked bumper: Device for acting as a pivot when in contact with a tree or log.
- M: Oil tank cap: Cap for closing the oil tank.
- N: Oil sight glass: Window to check chain oil amount.
- O: Hook: Tool for hanging the unit with rope etc.
- P: Oil feeder: Container for oil.
- Q: Chain case: Case for covering the guide bar and saw chain when the unit is not being used.
- R: Combi box spanner: The tool for removing or installing a side cover and tensioning the saw chain.
- S: Charger (sold separately): For charging the battery.

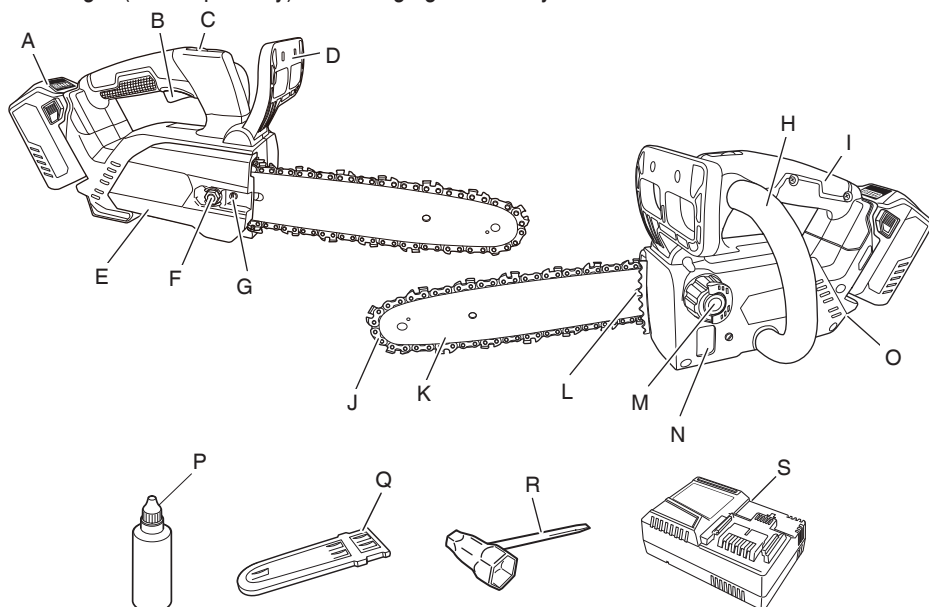

Fig. 1

English

WARNING

This chain saw (CS3625DC / CS3630DC) is designed especially for tree care and surgery. Only persons trained in tree care and surgery may use this saw. Observe all literature, procedures and recommendations from the relevant professional organization. Failure to do so constitutes a high accident risk. We recommend always using a rising platform for sawing in trees. Rappelling techniques are extremely dangerous and require special training. The operator must be trained in and familiar with the use of safety equipment and working and climbing techniques. Always use the restraining equipment for both the operator and the saw.

GENERAL POWER TOOL SAFETY WARNINGS

WARNING

Read all safety warnings, instructions, illustrations and specifications provided with this power tool.

Failure to follow all instructions listed below may result in electric shock, fire and/or serious injury.

Save all warnings and instructions for future reference.

The term "power tool" in the warnings refers to your mains-operated (corded) power tool or battery-operated (cordless) power tool.

1) Work area safety

a) **Keep work area clean and well lit.**

Cluttered or dark areas invite accidents.

b) **Do not operate power tools in explosive atmospheres, such as in the presence of flammable liquids, gases or dust.**

Power tools create sparks which may ignite the dust or fumes.

c) **Keep children and bystanders away while operating a power tool.**

Distractions can cause you to lose control.

2) Electrical safety

a) **Power tool plugs must match the outlet.**

Never modify the plug in any way.

Do not use any adapter plugs with earthed (grounded) power tools.

Unmodified plugs and matching outlets will reduce risk of electric shock.

b) **Avoid body contact with earthed or grounded surfaces, such as pipes, radiators, ranges and refrigerators.**

There is an increased risk of electric shock if your body is earthed or grounded.

c) **Do not expose power tools to rain or wet conditions.**

Water entering a power tool will increase the risk of electric shock.

d) **Do not abuse the cord. Never use the cord for carrying, pulling or unplugging the power tool.**

Keep cord away from heat, oil, sharp edges or moving parts.

Damaged or entangled cords increase the risk of electric shock.

e) **When operating a power tool outdoors, use an extension cord suitable for outdoor use.**

Use of a cord suitable for outdoor use reduces the risk of electric shock.

- f) **If operating a power tool in a damp location is unavoidable, use a residual current device (RCD) protected supply.**

Use of an RCD reduces the risk of electric shock.

3) Personal safety

- a) **Stay alert, watch what you are doing and use common sense when operating a power tool.**

Do not use a power tool while you are tired or under the influence of drugs, alcohol or medication.

A moment of inattention while operating power tools may result in serious personal injury.

- b) **Use personal protective equipment. Always wear eye protection.**

Protective equipment such as a dust mask, non-skid safety shoes, hard hat or hearing protection used for appropriate conditions will reduce personal injuries.

- c) **Prevent unintentional starting. Ensure the switch is in the off-position before connecting to power source and/or battery pack, picking up or carrying the tool.**

Carrying power tools with your finger on the switch or energising power tools that have the switch on invites accidents.

- d) **Remove any adjusting key or wrench before turning the power tool on.**

A wrench or a key left attached to a rotating part of the power tool may result in personal injury.

- e) **Do not overreach. Keep proper footing and balance at all times.**

This enables better control of the power tool in unexpected situations.

- f) **Dress properly. Do not wear loose clothing or jewellery. Keep your hair, clothing and gloves away from moving parts.**

Loose clothes, jewellery or long hair can be caught in moving parts.

- g) **If devices are provided for the connection of dust extraction and collection facilities, ensure these are connected and properly used.**

Use of dust collection can reduce dust-related hazards.

- h) **Do not let familiarity gained from frequent use of tools allow you to become complacent and ignore tool safety principles.**

A careless action can cause severe injury within a fraction of a second.

4) Power tool use and care

- a) **Do not force the power tool. Use the correct power tool for your application.**

The correct power tool will do the job better and safer at the rate for which it was designed.

- b) **Do not use the power tool if the switch does not turn it on and off.**

Any power tool that cannot be controlled with the switch is dangerous and must be repaired.

- c) **Disconnect the plug from the power source and/or remove the battery pack, if detachable, from the power tool before making any adjustments, changing accessories, or storing power tools.**

Such preventive safety measures reduce the risk of starting the power tool accidentally.

English

- d) **Store idle power tools out of the reach of children and do not allow persons unfamiliar with the power tool or these instructions to operate the power tool.**
Power tools are dangerous in the hands of untrained users.
 - e) **Maintain power tools and accessories. Check for misalignment or binding of moving parts, breakage of parts and any other condition that may affect the power tool's operation.**
If damaged, have the power tool repaired before use.
Many accidents are caused by poorly maintained power tools.
 - f) **Keep cutting tools sharp and clean.**
Properly maintained cutting tools with sharp cutting edges are less likely to bind and are easier to control.
 - g) **Use the power tool, accessories and tool bits etc. in accordance with these instructions, taking into account the working conditions and the work to be performed.**
Use of the power tool for operations different from those intended could result in a hazardous situation.
 - h) **Keep handles and grasping surfaces dry, clean and free from oil and grease.**
Slippery handles and grasping surfaces do not allow for safe handling and control of the tool in unexpected situations.
- 5) **Battery tool use and care**
- a) **Recharge only with the charger specified by the manufacturer.**
A charger that is suitable for one type of battery pack may create a risk of fire when used with another battery pack.
 - b) **Use power tools only with specifically designated battery packs.**
Use of any other battery packs may create a risk of injury and fire.
 - c) **When battery pack is not in use, keep it away from other metal objects, like paper clips, coins, keys, nails, screws or other small metal objects, that can make a connection from one terminal to another.**
Shorting the battery terminals together may cause burns or a fire.
 - d) **Under abusive conditions, liquid may be ejected from the battery; avoid contact. If contact accidentally occurs, flush with water. If liquid contacts eyes, additionally seek medical help.**
Liquid ejected from the battery may cause irritation or burns.
 - e) **Do not use a battery pack or tool that is damaged or modified.**
Damaged or modified batteries may exhibit unpredictable behaviour resulting in fire, explosion or risk of injury.
 - f) **Do not expose a battery pack or tool to fire or excessive temperature.**
Exposure to fire or temperature above 130 °C may cause explosion.
 - g) **Follow all charging instructions and do not charge the battery pack or tool outside the temperature range specified in the instructions.**
Charging improperly or at temperatures outside the specified range may damage the battery and increase the risk of fire.

6) Service

- a) **Have your power tool serviced by a qualified repair person using only identical replacement parts.**

This will ensure that the safety of the power tool is maintained.

- b) **Never service damaged battery packs.**

Service of battery packs should only be performed by the manufacturer or authorized service providers.

CAUTION

Keep children and infirm persons away.

When not in use, tools should be stored out of reach of children and infirm persons.

CORDLESS CHAIN SAW SAFETY WARNINGS1) **General chain saw safety warnings**

- a) **This chain saw is not intended for tree felling.** Use of the chain saw for operations different than intended could result in serious injury to the operator or bystanders.
- b) **The operator must be trained in safe climbing techniques and in the use of all recommended additional safety equipment, such as harness, loops, straps, rope and karabiners, and other fall arrest systems for the operator and the saw.** Establishing a secure location in the tree at each working position is essential to avoid a hazardous situation.
- c) **Wear eye protection, ear protection and protective equipment for head, forearms, hands, legs and feet that is suitable for tree climbing.** Adequate protective equipment will reduce personal injury from flying debris or accidental contact with the saw chain.
- d) **Cut wood only. Do not use chain saw for purposes not intended. For example: do not use chain saw for cutting metal, plastic, masonry or non-wood building materials.** Use of the chain saw for operations different than intended could result in a hazardous situation.
- e) **Always hold the chain saw with your right hand on the rear handle and your left hand on the front handle.** Holding the chain saw with a reversed hand configuration increases the risk of personal injury and should never be done.
- f) **Hold the chain saw by insulated gripping surfaces only, because the saw chain may contact hidden wiring.** Saw chains contacting a "live" wire may make exposed metal parts of the chain saw "live" and could give the operator an electric shock.
- g) **Keep all parts of the body away from the saw chain when the chain saw is operating. Before you start the chain saw, make sure the saw chain is not contacting anything.** A moment of inattention while operating chain saws may cause entanglement of your clothing or body with the saw chain.
- h) **When cutting a limb that is under tension, be alert for spring back.** When the tension in the wood fibres is released, the spring loaded limb may strike the operator and/or throw the chain saw out of control.
- i) **Use extreme caution when cutting thin branches.** The slender material may catch the saw chain and be whipped toward you or pull you off balance.

English

- j) **Follow all instructions when clearing jammed material, storing or servicing the chain saw. Make sure the switch is off and the battery pack is removed.** Unexpected actuation of the chain saw while clearing jammed material or servicing may result serious personal injury.
- k) **Carry the chain saw by the front handle with the chain saw switched off and away from your body. When transporting or storing the chain saw, always fit the guide bar cover.** Proper handling of the chain saw will reduce the likelihood of accidental contact with the moving saw chain.
- l) **Follow instructions for lubricating, chain tensioning and changing the bar and chain.** Improperly tensioned or lubricated chain may either break or increase the chance for kickback.

2) Causes and operator prevention of kickback:

Kickback may occur when the nose or tip of the guide bar touches an object, or when the wood closes in and pinches the saw chain in the cut. (Fig. 2)

Tip contact in some cases may cause a sudden reverse reaction, kicking the guide bar up and back towards the operator.

Pinching the saw chain along the top of the guide bar may push the guide bar rapidly back towards the operator.

Either of these reactions may cause you to lose control of the saw which could result in serious personal injury. Do not rely exclusively upon the safety devices built into your saw. As a chain saw user, you should take several steps to keep your cutting jobs free from accident or injury.

Kickback is the result of machine misuse and/or incorrect operating procedures or conditions and can be avoided by taking proper precautions as given below:

- a) **Maintain a firm grip, with thumbs and fingers encircling the chain saw handles, with both hands on the saw and position your body and arm to allow you to resist kickback forces. (Fig. 3)** Kickback forces can be controlled by the operator, if proper precautions are taken. Do not let go of the chain saw.
- b) **Do not overreach.** This helps prevent unintended tip contact and enables better control of the chain saw in unexpected situations.
- c) **Only use replacement guide bars and saw chains specified by the manufacturer.** Incorrect replacement guide bars and saw chains may cause chain breakage and/or kickback.
- d) **Follow the manufacturer's sharpening and maintenance instructions for the saw chain.** Decreasing the depth gauge height can lead to increased kickback.

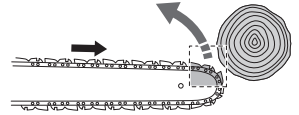

Fig. 2

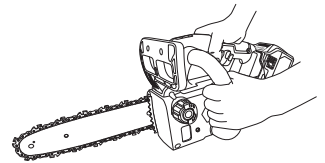

Fig. 3

ADDITIONAL SAFETY WARNINGS

1. **Work without pressure.** In addition, always keep your body warm.
2. **Keep all parts of the body away from the saw chain when the chain saw is operating.**
3. **Before commencing work, reflect fully on the work procedures involved and work to avoid accidents, otherwise injury may occur.**
4. **Do not use in the event of bad weather, such as strong wind, rain, snow, fog, or in areas prone to rockfall or avalanches.**
In bad weather, judgment may be impaired and the vibration may result in disaster.
5. **When visibility is poor, such as during bad weather or night, do not use the unit. In addition, do not use it in rain or in a location exposed to rain.**
Unstable foothold or loss of balance may result in an accident.
6. **Check the guide bar and saw chain before starting the unit.**
 - If the guide bar or saw chain is cracked, or the product is scratched or bent, do not use the unit.
 - Check if the guide bar and saw chain are securely installed. If the guide bar or saw chain is broken or dislodged, this may result in an accident.
7. **Before starting work, check to ensure the switch does not engage unless the lock-off lever is pressed.**
If the unit does not working properly, immediately stop using and request repair from your HiKOKI Authorized Service Center.
8. **Install the saw chain properly, in accordance with the instruction manual.**
If installed incorrectly, the saw chain will come off the guide bar and injury may occur.
9. **Never remove any of the safety devices equipped on the chain saw (chain brake, lock-off lever, chain catcher etc.).**
In addition, do not alter or immobilize them.
Injury may occur.
10. **In the following cases, switch the unit off and ensure the saw chain is no longer moving:**
 - When not in use.
 - When shifting to a new work location.
 - When inspecting, adjusting or replacing the saw chain, guide bar, chain case and any other part.
 - When refilling the chain oil.
 - When removing dust etc. from the body.
 - When removing obstacles, trash or sawdust generated from work from the work area.
 - When you take off the unit, or when you get away from the unit.
 - Otherwise, if you sense danger or anticipate risk.
If the saw chain is still moving, an accident may occur.
11. **Work should generally be performed individually. When multiple individuals are involved, ensure sufficient spacing between them.**

English

12. **Remain more than 15 m away from other people.**

In addition, when working with multiple persons, remain 15 m or more apart.

 - There is a risk of impact with scatters and other accidents.
 - Prepare a whistle alert etc. and determine appropriate contact method for other workers beforehand.
13. **Before cutting standing trees, ensure the following:**
 - Determine a safe evacuation location prior to cutting.
 - Remove obstacles (e.g., branches, shrubs) in advance.
14. **During use, if the unit performance deteriorates, or you notice any abnormal sound or vibration, immediately switch off and discontinue use, and return to your HiKOKI Authorized Service Center for inspection or repair.**

If you continue using, injury may occur.
15. **If the unit is accidentally dropped or exposed to impact, inspect carefully for damage or cracks and ensure there is no deformation.**

If the unit is damaged, cracked or deformed, injury may occur.
16. **When transporting the unit by car, secure the unit to prevent it moving.**

There is a risk of accident.
17. **Do not switch the unit on while the chain case is attached.**

Injury may occur.
18. **Ensure there are no nails and other foreign objects in the material.**

If the saw chain impact on the nail etc., injury may occur.
19. **To avoid the guide bar becoming entangled with the material when chopping on a verge or when subject to the weight of material while cutting, install a supporting platform close to the cutting position.**

If the guide bar becomes entangled, injury may occur.
20. **If the unit is to be transported or stored after use, either remove the saw chain, or attach the chain case.**

If the saw chain comes into contact with your body, injury may occur.
21. **Adequately care for the unit.**
 - To ensure work can be performed safely and efficiently, care for the saw chain to ensure it provides optimal cutting performance.
 - When replacing the saw chain or guide bar, maintaining the body, filling oil etc., follow the instruction manual.
22. **Ask the shop to repair the unit.**
 - Do not modify this product, since it already complies with the applicable safety standards.
 - Always refer to your HiKOKI Authorized Service Center for all repairs.

Attempting to repair the unit yourself may result in an accident or injury.
23. **When not using the unit, ensure it is properly stored.**

Drain off the chain oil, and keep in a dry place out of reach of children or a locked location.
24. **If the warning label is no longer visible, peels off or is otherwise unclear, apply a new warning label.**

For the warning label, refer to your HiKOKI Authorized Service Center.
25. **When working, if local rules or regulations apply, comply with the same.**
26. **Make sure that the battery is installed firmly. If it is at all loose it could come off and cause an accident.**

27. **Always charge the battery at a temperature of 0–40°C.**
A temperature of less than 0°C will result in over charging which is dangerous. The battery cannot be charged at a temperature greater than 40°C.
The most suitable temperature for charging is that of 20–25°C.
28. **Do not use the charger continuously.**
When one charging is completed, leave the charger for about 15 minutes before the next charging of battery.
29. **Do not allow foreign matter to enter the hole for connecting the rechargeable battery.**
30. **Never disassemble the rechargeable battery and charger.**
31. **Never short-circuit the rechargeable battery.** Shortcircuiting the battery will cause a great electric current and overheat. It results in burn or damage to the battery.
32. **Do not dispose of the battery in fire.** If the battery is burnt, it may explode.
33. **Bring the battery to the shop from which it was purchased as soon as the post-charging battery life becomes too short for practical use.** Do not dispose of the exhausted battery.
34. **Do not insert object into the air ventilation slots of the charger.** Inserting metal objects or inflammables into the charger air ventilation slots will result in electrical shock hazard or damaged charger.
35. **When using this unit continuously, the unit may overheat, leading to damage in the motor and switch.** Therefore, whenever the housing becomes hot, give the tool a break for a while.
36. **Make sure that the battery is installed firmly.** If it is at all loose it could come off and cause an accident.
37. **Do not use the product if the tool or the battery terminals (battery mount) are deformed.**
Installing the battery could cause a short circuit that could result in smoke emission or ignition.
38. **Keep the tool's terminals (battery mount) free of swarf and dust.**
 - Prior to use, make sure that swarf and dust have not collected in the area of the terminals.
 - During use, try to avoid swarf or dust on the tool from falling on the battery.
 - When suspending operation or after use, do not leave the tool in an area where it may be exposed to falling swarf or dust.

Doing so could cause a short circuit that could result in smoke emission or ignition.
39. **Always use the tool and battery at temperatures between -5°C and 40°C.**

CAUTION ON LITHIUM-ION BATTERY

To extend the lifetime, the lithium-ion battery equips with the protection function to stop the output.

In the cases of 1 to 3 described below, when using this product, even if you are pulling the switch, the motor may stop. This is not the trouble but the result of protection function.

1. **When the battery power remaining runs out, the motor stops.**
In such case, charge it up immediately.

English

2. If the tool is overloaded, the motor may stop. In this case, release the switch of tool and eliminate causes of overloading. After that, you can use it again.
3. If the battery is overheated under overload work, the battery power may stop. In this case, stop using the battery and let the battery cool. After that, you can use it again.

Furthermore, please heed the following warning and caution.

WARNING

In order to prevent any battery leakage, heat generation, smoke emission, explosion and ignition beforehand, please be sure to heed the following precautions.

1. Make sure that swarf and dust do not collect on the battery.
 - During work make sure that swarf and dust do not fall on the battery.
 - Make sure that any swarf and dust falling on the power tool during work do not collect on the battery.
 - Do not store an unused battery in a location exposed to swarf and dust.
 - Before storing a battery, remove any swarf and dust that may adhere to it and do not store it together with metal parts (screws, nails, etc.).
2. Do not pierce battery with a sharp object such as a nail, strike with a hammer, step on, throw or subject the battery to severe physical shock.
3. Do not use an apparently damaged or deformed battery.
4. Do not use the battery for a purpose other than those specified.
5. If the battery charging fails to complete even when a specified recharging time has elapsed, immediately stop further recharging.
6. Do not put or subject the battery to high temperatures or high pressure such as into a microwave oven, dryer, or high pressure container.
7. Keep away from fire immediately when leakage or foul odor are detected.
8. Do not use in a location where strong static electricity generates.
9. If there is battery leakage, foul odor, heat generated, discolored or deformed, or in any way appears abnormal during use, recharging or storage, immediately remove it from the equipment or battery charger, and stop use.
10. Do not immerse the battery or allow any fluids to flow inside. Conductive liquid ingress, such as water, can cause damage resulting in fire or explosion. Store your battery in a cool, dry place, away from combustible and flammable items. Corrosive gas atmospheres must be avoided.

CAUTION

1. If liquid leaking from the battery gets into your eyes, do not rub your eyes and wash them well with fresh clean water such as tap water and contact a doctor immediately. If left untreated, the liquid may cause eye-problems.
2. If liquid leaks onto your skin or clothes, wash well with clean water such as tap water immediately.
There is a possibility that this can cause skin irritation.
3. If you find rust, foul odor, overheating, discolor, deformation, and/or other irregularities when using the battery for the first time, do not use and return it to your supplier or vendor.

WARNING

If an electrically conductive foreign object enters the terminals of the lithium ion battery, a short-circuit may occur resulting in the risk of fire. Please observe the following matters when storing the battery.

- Do not place electrically conductive cuttings, nails, steel wire, copper wire or other wire in the storage case.
- Either install the battery in the power tool or store by securely pressing into the battery cover until the ventilation holes are concealed to prevent short-circuits (Fig. 4).

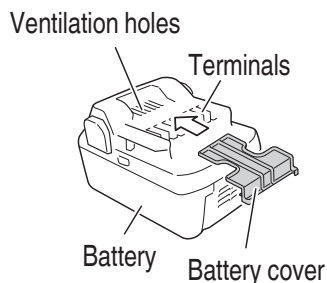

Fig. 4

REGARDING LITHIUM-ION BATTERY TRANSPORTATION

When transporting a lithium-ion battery, please observe the following precautions.

WARNING

Notify the transporting company that a package contains a lithium-ion battery, inform the company of its power output and follow the instructions of the transportation company when arranging transport.

- Lithium-ion batteries that exceed a power output of 100 Wh are considered to be in the freight classification of Dangerous Goods and will require special application procedures. (Fig. 5)
- For transportation abroad, you must comply with international law and the rules and regulations of the destination country.

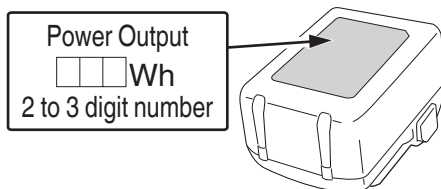

Fig. 5

USB DEVICE CONNECTION PRECAUTIONS

When an unexpected problem occurs, the data in a USB device connected to this product may be corrupted or lost.

Always make sure to back up any data contained in the USB device prior to use with this product.

Please be aware that our company accepts absolutely no responsibility for any data stored in a USB device that is corrupted or lost, nor for any damage that may occur to a connected device.

SPECIFICATIONS

POWER TOOL

Model	CS3625DC	CS3630DC
Voltage	36 V	
Saw chain	Type: 90PX-040 Pitch: 9.5 mm (3/8") Gauge: 1.1 mm (0.043")	Type: 90PX-045 Pitch: 9.5 mm (3/8") Gauge: 1.1 mm (0.043")
Guide bar	Type: 104MLEA041 Size: 250 mm (Max. cutting length)	Type: 124MLEA041 Size: 300 mm (Max. cutting length)
Sprocket	Number of teeth: 6 Pitch 9.5 mm (3/8")	
No-load chain speed	12.6 m/s (760 m/min)	
Chain oil tank capacity	70 ml	
Battery*	BSL36A18: Li-ion 36 V / 18 V (2.5 Ah / 5.0 Ah 10 cells)	
Weight	3.1 kg (BSL36A18 attached)	3.2 kg (BSL36A18 attached)

* Existing batteries (BSL3660/3626/3620, BSL18 series, etc.) cannot be used with this tool.





Charger

Model	UC18YSL3
Charging voltage	14.4–18 V
Weight	0.6 kg

STANDARD ACCESSORIES

In addition to the main unit (1 unit), the package contains the accessories listed in the below.

Table 1

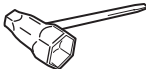
		CS3625DC, CS3630DC (XC)
Chain case		1
Guide bar		1
Saw chain		1
Oil feeder		1
Combi box spanner		1

APPLICATIONS

- Cutting of timber/logs
- Pruning of garden trees

BATTERY REMOVAL/INSTALLATION

1. **Battery removal**
Hold the handle tightly and push the battery latches (2 pcs.) to remove the battery (**Fig. 6**).

CAUTION

Never short-circuit the battery.

2. **Battery installation**
Insert the battery while observing its polarities (**Fig. 6**).

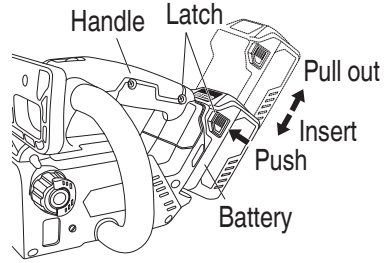

Fig. 6

CHARGING

Before using the power tool, charge the battery as follows.

1. **Connect the charger's power cord to the receptacle.**
When connecting the plug of the charger to a receptacle, the pilot lamp will blink in red (At 1- second intervals).
2. **Insert the battery into the charger.**
Firmly insert the battery into the charger as shown in **Fig. 7**.
3. **Charging**
When inserting a battery in the charger, the charge indicator lamp will blink in blue.
When the battery becomes fully recharged, the charge indicator lamp will light up in green. (See **Table 2**)

- (1) **Charge indicator lamp indication**
The indications of the charge indicator lamp will be as shown in **Table 2**, according to the condition of the charger or the rechargeable battery.

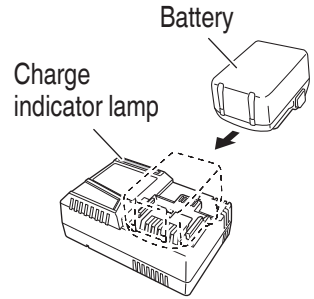









Fig. 7

Table 2

Indications of the charge indicator lamp				
Charge indicator lamp (RED / BLUE / GREEN / PURPLE)	Before charging	Blinks (RED)	Lights for 0.5 seconds. Does not light for 0.5 seconds. (off for 0.5 seconds) 	Plugged into power source*1
	While charging	Blinks (BLUE)	Lights for 0.5 seconds. Does not light for 1 second. (off for 1 second) 	Battery capacity at less than 50%
		Blinks (BLUE)	Lights for 1 second. Does not light for 0.5 seconds. (off for 0.5 seconds) 	Battery capacity at less than 80%
		Lights (BLUE)	Lights continuously 	Battery capacity at more than 80%
	Charging complete	Lights (GREEN)	Lights continuously  (Continuous buzzer sound: about 6 seconds)	
	Overheat standby	Blinks (RED)	Lights for 0.3 seconds. Does not light for 0.3 seconds. (off for 0.3 seconds) 	Battery overheated. Unable to charge. (Charging will commence when battery cools)*2
	Charging impossible	Flickers (PURPLE)	Lights for 0.1 seconds. Does not light for 0.1 seconds. (off for 0.1 seconds)  (Intermittent buzzer sound: about 2 seconds)	Malfunction in the battery or the charger*3

*1 If the red lamp continues to blink even after the charger has been attached, check to confirm that the battery has been fully inserted.

*2 Although charging will start once the battery has cooled down even when left in situ, the best practice is to remove the battery and allow it to cool down in a shaded, well-ventilated location before charging.

*3

○ Fully insert the battery.

○ Check to confirm that no foreign matter is stuck to the battery mount or terminals.

<If charging takes a long time>

○ Charging will take longer at extremely low ambient temperatures. Charge the battery in a warm location (such as indoors).

English

- Do not block the air vent. Otherwise the interior will overheat, reducing the charger's performance.
 - If the cooling fan is not operating, contact a HiKOKI Authorized Service Center for repairs.
- (2) Regarding the temperatures and charging time of the rechargeable battery
The temperatures and charging time will become as shown in **Table 3**.

Table 3

Battery		Charger	UC18YSL3	
Type of battery			Li-ion	
Charging voltage			14.4–18 V	
Temperatures at which the battery can be recharged			0°C–50°C	
Charging time for battery capacity, approx. (At 20°C)		1.5 Ah	15 min	
		2.0 Ah	20 min	
		2.5 Ah	25 min	
		3.0 Ah	20 min (BSL1430C, BSL1830C: 30 min)	
		4.0 Ah	26 min (BSL1840M: 40 min)	
		5.0 Ah	32 min	
		6.0 Ah	38 min	
		8.0 Ah	52 min	
		Multi volt battery	1.5 Ah (× 2 unit)	20 min
			2.5 Ah (× 2 unit)	32 min
4.0 Ah (× 2 unit)	52 min			
Number of battery cells			4–10	
Charging voltage for USB			5 V	
Charging current for USB			2 A	
Weight			0.6 kg	

NOTE

The recharging time may vary according to the ambient temperature and power source voltage.

4. **Disconnect the charger's power cord from the receptacle.**
5. **Hold the charger firmly and pull out the battery.**

NOTE

Be sure to pull out the battery from the charger after use, and then keep it.

Regarding electric discharge in case of new batteries, etc.

As the internal chemical substance of new batteries and batteries that have not been used for an extended period is not activated, the electric discharge might be low when using them the first and second time. This is a temporary phenomenon, and normal time required for recharging will be restored by recharging the batteries 2–3 times.

How to make the batteries perform longer.

- (1) Recharge the batteries before they become completely exhausted.
When you feel that the power of the tool becomes weaker, stop using the tool and recharge its battery. If you continue to use the tool and exhaust the electric current, the battery may be damaged and its life will become shorter.
- (2) Avoid recharging at high temperatures.
A rechargeable battery will be hot immediately after use. If such a battery is recharged immediately after use, its internal chemical substance will deteriorate, and the battery life will be shortened. Leave the battery and recharge it after it has cooled for a while.

CAUTION

- **If the battery is charged while it is heated because it has been left for a long time in a location subject to direct sunlight or because the battery has just been used, the charge indicator lamp of the charger lights for 0.3 seconds, does not light for 0.3 seconds (off for 0.3 seconds). In such a case, first let the battery cool, then start charging.**
- **When the charge indicator lamp flickers (at 0.2-second intervals), check for and take out any foreign objects in the charger's battery connector. If there are no foreign objects, it is probable that the battery or charger is malfunctioning. Take it to your authorized Service Center.**

HOW TO RECHARGE USB DEVICE

WARNING

- **Prior to use, check the connecting USB cable for any defect or damage. Using a defective or damaged USB cable can cause smoke emission or ignition.**
- **When the product is not being used, cover the USB port with the rubber cover. Buildup of dust etc. in the USB port can cause smoke emission or ignition.**

NOTE

- There may be an occasional pause during USB recharging.
- When a USB device is not being charged, remove the USB device from the charger. Failure to do so may not only reduce the battery life of a USB device, but may also result in unexpected accidents.
- It may not be possible to charge some USB devices, depending on the type of device.

English

- (1) Select a charging method
Depending on the charge method selected, either the battery is inserted into the charger or the power cord is plugged into an outlet.
 - Charging a USB device from a electrical outlet. (Fig. 8-a)
 - Charging a USB device and battery from a electrical outlet. (Fig. 8-b)

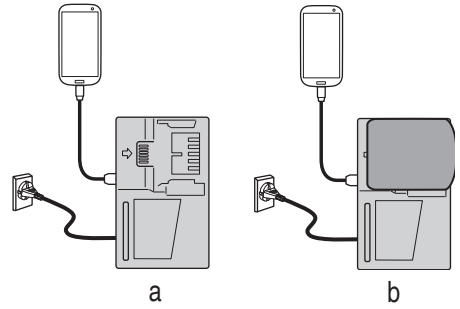

Fig. 8

- (2) Connect the USB cable. (Fig. 9)
Pull back the rubber cover and firmly plug in a commercially available USB cable (appropriate to the device being charged) into the USB port.

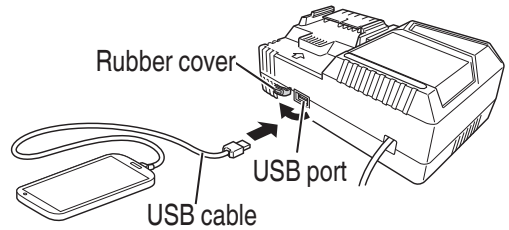

Fig. 9

- (3) When charging is completed
 - To verify charge status, check the USB device.
 - Unplug the power cord from the electrical outlet. (Fig. 10)
 - Place the rubber cover over the USB port.

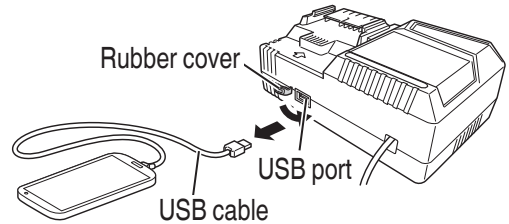

Fig. 10

INSTALLING (REPLACING) SAW CHAIN

WARNING

- To prevent accidents, always switch the unit off, and remove the battery.
- Don't use the saw chain or the guide bar other than those specified in "SPECIFICATIONS".

CAUTION

Wear thick gloves and be careful to avoid injury with the saw chain.

NOTE

- When removing the saw chain, remove sawdust from the oil spout, oil hole, and guide bar groove. If sawdust accumulates, this may cause the unit to fail.
- Use the correct type of saw chain in accordance with the specifications.
If you install the wrong type of guide bar, the saw chain may come off and injury may occur.

1. Removing the side cover (Fig. 11)

Turn the nut and remove the side cover.

2. Removing the saw chain and guide bar (Fig. 12)

Rotate the tensioning screw in the “-” direction to introduce a small amount of slack in the saw chain, then detach from the sprocket. Detach along with the guide bar in the direction indicated by the arrow.

3. Engaging the new saw chain in the sprocket (Fig. 13)

- ① Attach the saw chain from the guide bar tip. Make sure the saw chain is oriented so that the blade faces in the direction shown in the illustration below the sprocket.
- ② Insert the bolt and chain tensioner boss into the hole in the guide bar while holding the chain and guide bar tip. Engage the end of the saw chain to the sprocket and mount the guide bar to the saw body.

4. Installing the side cover (Fig. 14)

- ① Attach the side cover by inserting the lug into the slot in the saw body. Make sure the saw chain does not come loose from the guide bar.
- ② Rotate the nut once to temporarily fix it. Remove any dirt around the side cover before reattaching.

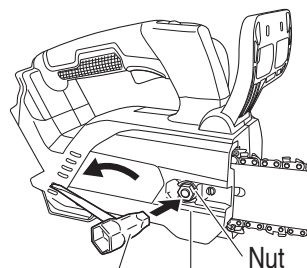

Combi box spanner Side cover
Fig. 11

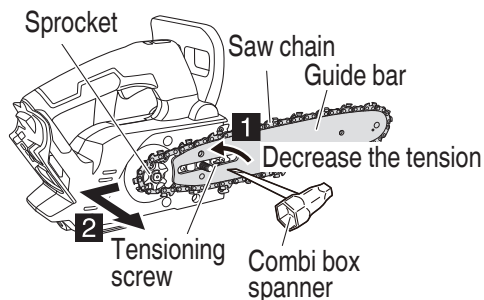

Fig. 12

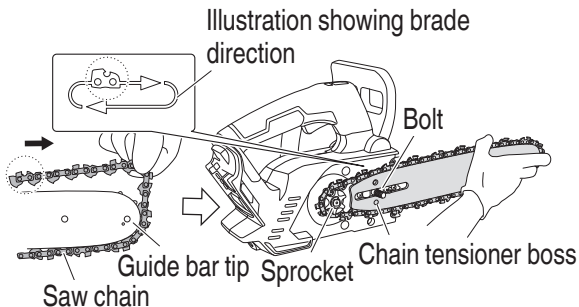

Fig. 13

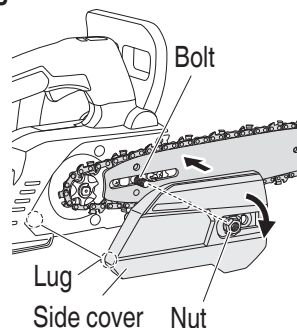

Fig. 14

English

5. Adjusting the saw chain tension (Fig. 15)

- While lifting the guide bar tip, turn the tensioning screw to adjust the saw chain tension.
- Turn the tensioning screw to the "+" to increase the saw chain tension, and to the "-" to decrease it.

6. Checking the saw chain tension (Fig. 16)

Adjust the saw chain tension so that the gap between the saw chain drive link and the guide bar is 0.5 to 1 mm when you lift the saw chain slightly near the center of the guide bar.

7. Securing the nut (Fig. 17)

When adjustment is complete, lift up the guide bar, and fully tighten the nut.

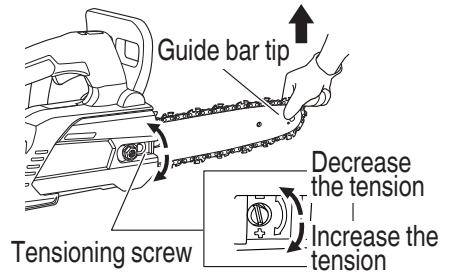

Fig. 15

WARNING

After adjusting the saw chain tension, ensure the nut is fully tightened. If it is loose, injury may occur.

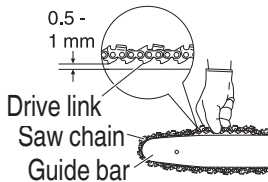

Fig. 16

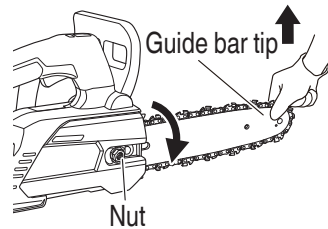

Fig. 17

INSPECTION AND PREPARATION PRIOR TO USE

Prior to use, make the following inspection and preparation.

WARNING

- To prevent accidents, always perform steps 1 to 3 ensuring the battery is removed from the body.
- Do not secure the lock-off lever in the slid position. If the switch is accidentally engaged, the unit may unexpectedly start and injury may occur.

1. Ensuring the switch is off

- If you insert the battery without knowing whether the switch is engaged, the unit may unexpectedly start, which may result in an accident.
- When the switch is engaged while the lock-off lever in the slid position, the unit switches on, and when the switch is released, the unit switches off.

2. Checking the saw chain tension

- If the saw chain tension is incorrect, there is a risk of damage to the saw chain or guide bar and malfunction. Referring to steps 5 to 7 “Installing (replacing) saw chain,” ensure an appropriate tension is set.
- While the saw chain is still new, it is particularly stretchy, so periodically check the tension and adjust as required.
- Also check the nut is securely tightened.

3. Checking the chain oil

- This unit is delivered without chain oil inside. Ensure the oil tank is filled with the chain oil provided before use. (Fig. 18)
 - Periodically check the oil sight glass during work and replenish oil as required.
 - If the chain oil supplied runs out, use HiKOKI chain oil sold separately or equivalent chain oil on the market.
 - The chain oil lubricates automatically.
- The discharge rate for auto lubrication is factory preset to the maximum.

To reduce the discharge rate, turn the oil pump adjuster on the right side of the oil sight glass clockwise. (Fig. 19)

NOTE

- The oil tank capacity is about 70 ml.
Make sure no oil leaks or overflows from the oil tank when replenishing the chain oil.
 - We recommend that you stock up with chain oil.
If you continue working without chain oil, the saw chain may burn through, or the motor may fail.
 - Be careful to avoid dust or other foreign matter from entering the oil tank.
If dust and other foreign matter enter the oil tank, the unit may fail.
 - Chain oil left in the tank may leak due to the structure of this unit. Although this does not indicate a malfunction, it may soil the storage location, so be careful.
When storing, empty the oil from the oil tank, and place an item under the main body which can absorb any leaks.
 - Replenish the oil after every approximately 10 minutes of operation. (*Varies depending on the cutting usage conditions)
- ## 4. Installing the battery (Fig. 6 on page 48)
- As shown in Fig. 6 on page 48, push firmly until it clicks into place.

CAUTION

Securely attach the battery.

If the battery is not securely attached, it may come off and injury may occur.

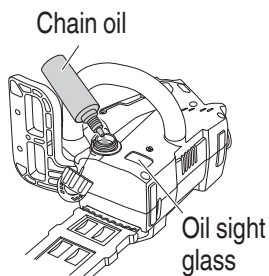

Fig. 18

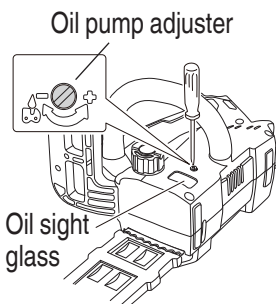

Fig. 19

English

5. Checking operation of chain brake (Fig. 20)

WARNING

- Although the chain brake is an emergency stop device, this is not completely reliable. Operate carefully to avoid the risk of kickback.
- The chain brake is intended for use in emergencies and when starting up. Do not use it indiscriminately.
- To avoid impaired movement of the chain brake due to buildup of sawdust etc., clean regularly.
- The chain brake is an important component to ensure safe use. If you have any concern regarding the chain brake operation, request repair from your HiKOKI Authorized Service Center.

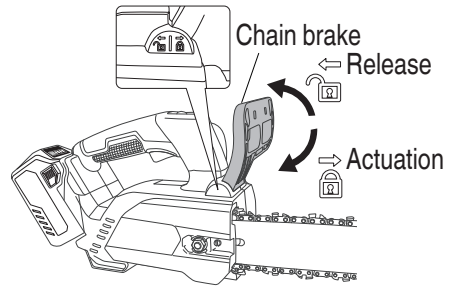

Fig. 20

The chain brake is an emergency stop device that stops the saw chain when the unit is subject to kickback etc., to reduce risk.

(Refer to “Causes and operator prevention of kickback”.)

Push the chain brake in the direction indicated by the arrow to apply the chain brake and stop the saw chain (Fig. 20). To release the chain brake, release the switch and pull back on the chain brake.

CAUTION

The chain brake functions only when power is turned on. Check chain brake function in a location with no people or obstructions nearby.

- ① Press the switch while sliding the lock-off lever.
- ② Once the saw chain begins turning, push the chain brake forward toward the saw chain.
- ③ If the saw chain stops, the chain brake is functioning as it should. To release the brake, release the switch and pull back on the chain brake.

6. Checking chain oil discharge (Fig. 21)

- When switching the unit on, chain oil automatically lubricates the saw chain and guide bar.
- If oil does not seem to emerge 2 to 3 minutes after the unit starts, check if any sawdust has accumulated around the oil spout. (Refer to “Cleaning the chain oil spout.”) (Refer to “Checking the chain oil.”)

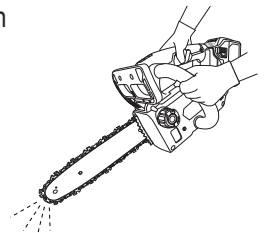

Fig. 21

7. Using the hook

By tying a rope, etc. to the hook, you can suspend the unit.

WARNING

When using the hook, ensure the unit is securely suspended to avoid the risk of falling. If the unit falls, an accident may occur.

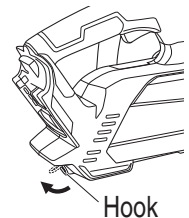

Fig. 22

CUTTING PROCEDURES

WARNING

- When working in trees, wear appropriate protection on your eyes, head, hands, legs, and arms, as well as slip-resistant foot protection.
- Prior to operation, ensure that chain brake works.
- During use, grip the handle securely with both hands. (Fig. 3 on page 40)
- When cutting timber from the bottom, ensure the saw chain does not impact with the timber.
If the unit is pushed back, injury may occur.
- During work breaks or after work, always switch the unit off, and remove the battery from the main body.

Always monitor the workplace and surrounding area, ensure there are no objects which could cause injuries, accidents or failure, and if any are present, remove them in advance. In particular, when establishing a foothold for working, ensure there is no instability or any object which could be tripped over.

- ① **Ensuring the unit is switched off**
If the battery is inserted while the switch is unknowingly engaged, the unit may unexpectedly start, which may result in an accident.
- ② **Installing the battery (Fig. 6 on page 48)**
As shown in **Fig. 6 on page 48**, push firmly until it clicks into place.
- ③ **Engaging the switch**
Ensuring the saw chain is not in contact with the timber, engage the switch, and start cutting when the saw chain speed has increased.

CAUTION

- When switching the unit on, ensure the saw chain does not contact with material or anything else.
- During use, be careful to ensure the saw chain does not contact with other material or object. In particular, when you have finished cutting, be careful to ensure it does not touch the ground.

NOTE

Refill the oil tank early to prevent the unit running out of oil.

1. Switch operation

When the switch is engaged while sliding the lock-off lever, the saw chain rotates (**Fig. 23**). Unless the lock-off lever is being slid, the switch cannot be engaged. After the switch is engaged, the saw chain continues rotating as long as it is pressed down. When the switch is released, a brake is applied to stop the saw chain rotation.

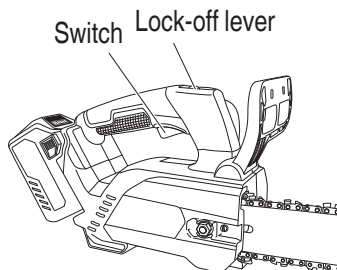

Fig. 23

English

2. General cutting procedures

- (1) Switch ON the power while keeping the saw slightly away from the wood to be cut. Start sawing only after the unit has reached full speed.
- (2) When sawing a slender piece of wood, press the base section of the guide bar against the wood and saw downward as shown in **Fig. 24**.
- (3) When sawing a thick piece of wood, press the spike on the front section of the unit against the wood and cut it with a lever action while using the spike as a fulcrum as shown in **Fig. 25**.
- (4) When cutting wood horizontally, turn the unit body to the right so that the guide bar is below and hold the upper side of the front handle with your left hand. Hold the guide bar horizontally and place the spike that is on the front of the unit body on the lumbar. Using the spike as a fulcrum, cut into the wood by turning the rear handle to the right. (**Fig. 26**)
- (5) When cutting into wood from the bottom, touch the upper part of the guide bar to the wood lightly. (**Fig. 27**)
- (6) As well as carefully studying the handling instructions, ensure practical instruction in the operation of the chain saw prior to use, or at least practice working with the chain saw by cutting lengths of round timber on a sawing trestle.
- (7) When cutting logs or timbers which are not supported, support them properly by immobilizing them during cutting using a sawing trestle or other proper method.

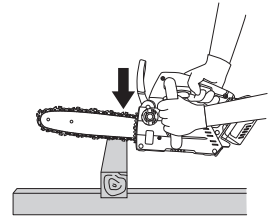

Fig. 24

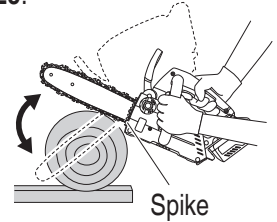

Fig. 25

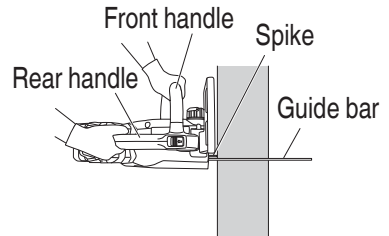

Fig. 26

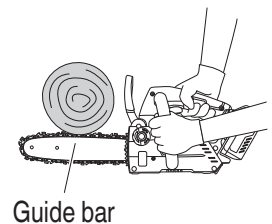

Fig. 27

CAUTION

- When cutting wood from the bottom, there is a danger that the unit body may be pushed back toward the user if the chain strongly impacts with the wood.
- Do not cut all the way thorough the wood by starting from the bottom since there is the danger of the guide bar flying up out of control when the cut is finished.
- Always prevent the operating chain saw from touching the ground or wire fences.

3. Branch cutting

(1) Cutting branches from a standing tree:

A thick branch should initially be cut off at a point away from the trunk of the tree.

First cut in about one third of the way from below, and then cut off the branch from above. Finally, cut off the remaining portion of the branch even with the trunk of the tree. (Fig. 28)



Fig. 28

CAUTION

- Always be careful to avoid falling branches.
- Always be alert for chain saw recoil.

(2) Cutting branches from fallen trees:

First cut off branches that do not touch the ground, then cut off those which touch the ground. When cutting thick branches that touch the ground, first cut in about half of the way from above, then cut the branch off from below. (Fig. 29)

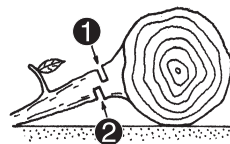

Fig. 29

CAUTION

- When cutting off branches which touch the ground, be careful that the guide bar does not become bound by pressure.
- During the final cutting stage, beware of the log suddenly rolling.

4. Log cutting

When cutting a log positioned as shown in Fig. 30, first cut in about one third of the way from below, then cut down all the way from above. When cutting a log that straddles a hollow as shown in Fig. 31, first cut in about two thirds of the way from above, then cut upward from below.

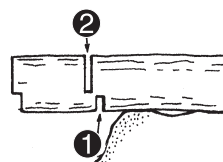

Fig. 30

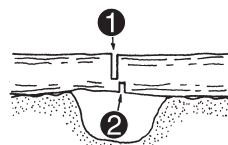

Fig. 31

CAUTION

- Ensure the guide bar does not become bound in the log by pressure.
- When working on inclined ground, be sure to stand on the uphill side of the log. If you stand on the downhill side, the cut-off log may roll toward you.

5. Cutting a log laid flat

Make sure the log is stable.

Push the spike against the log. Use the spike as a fulcrum about which the handle can be lifted to facilitate cutting. (Fig. 32)

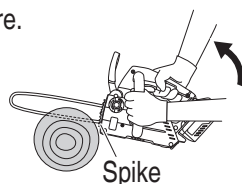

Fig. 32

6. Cutting a log supported at both ends

Start by sawing to a depth of approximately one third from the top, then saw from underneath to complete the cut.

The guide bar may become stuck within the saw cut if you attempt to cut all the way through from the top. (Fig. 33)

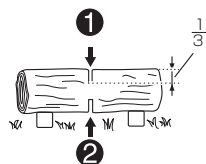

Fig. 33

Precaution for cutting work

For large-scale operation or non-stop work

This tool comes with an over-heat protection circuit that protects the electronic parts that control the rechargeable battery. During sustained use or during operations under high loads generated by pressure against the tool, tool temperature will rise and eventually trigger the over-heat protection circuit, which will shut down the tool.

If this happens, let the tool cool for a length of time. When the temperature drops, it will again become possible to use the tool. When the rechargeable battery has to be exchanged during continuous operation, let the tool rest for about 15 minutes.

Gripping/pushing force of chain saw

Always grip the chain saw securely.

In addition, do not force the chain saw more than necessary. When cutting, additional force exerted on the chain saw will not accelerate the cutting speed. This will strain the motor, impair the performance, and damage or cause malfunction of the motor or guide bar.

Use the unit in the range where the saw chain is at a reasonable speed.

In particular, when the saw chain stops (becomes jammed) due to the excessive force, it may cause an injury or failure of the unit.

Chain catcher

- The chain catcher is located on the power head just below the chain to further prevent the possibility of a broken chain striking the chain saw user.
- When the saw chain is cut, replace it with a new one referring to “Installing (replacing) saw chain”.

8. About remaining battery indicator

You can check the battery's remaining capacity by pressing the remaining battery indicator switch to light the indicator lamp.

(Fig. 34, Table 4)

The indicator will shut off approximately 3 seconds after the remaining battery indicator switch is pressed.

It is best to use the remaining battery indicator as a guide since there are slight differences such as ambient temperature and the condition of the battery.

Remaining battery indicator lamp Remaining battery indicator switch

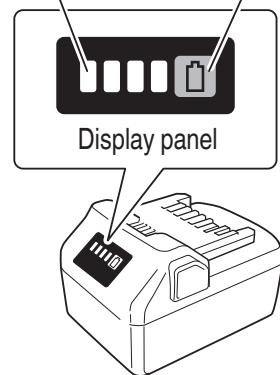





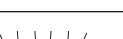



Fig. 34

Table 4

State of lamp	Battery Remaining Power
	Lights ; The battery remaining power is over 75%.
	Lights ; The battery remaining power is 50%–75%.
	Lights ; The battery remaining power is 25%–50%.
	Lights ; The battery remaining power is less than 25%.
	Blinks ; The battery remaining power is nearly empty. Recharge the battery soonest possible.
	Blinks ; Output suspended due to high temperature. Remove the battery from the tool and allow it to fully cool down.
	Blinks ; Output suspended due to failure or malfunction. The problem may be the battery so please contact your dealer.

NOTE

Do not give a strong shock to the display panel or break it. It may lead to a trouble.

SHARPENING OF THE CHAIN BLADE**WARNING**

To prevent accidents, always turn off the switch and remove the battery from the main body.

CAUTION

Always wear thick gloves when handling the saw chain.

NOTE

Sharpen the saw chain and adjust the depth gauge at the central position on the guide bar, with the saw chain attached to the main body.

When the sharpness of saw chains deteriorates, the motor and each part of the body are burdened and the efficiency declines.

For optimal performance of the unit, frequent maintenance is necessary to keep the saw chain sharp.

English

1. Blade sharpening

Use a 4 mm diameter round file.

The round file should be held against the chain blade so that one-fifth of its diameter extends above the top of the blade, as shown in **Fig. 35**.

Sharpen the blades by keeping the round file at a 30° angle in relation to the guide bar, as shown in **Fig. 36**.

File the blades by gently pushing the round file in the direction of the grip.

Make sure the round file does not touch the saw chain when drawing back the file.

Ensure that all saw blades are filed at the same angle, or the cutting efficiency of the tool will be impaired. Appropriate angles for sharpening the blades correctly are shown in **Fig. 37**. (Round file is sold separately.)

1/5 of diameter
of file

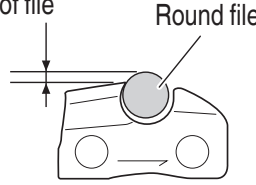

Fig. 35

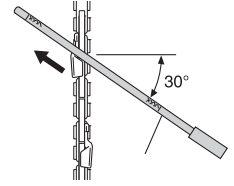

Fig. 36

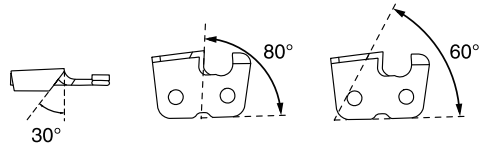

Fig. 37

2. Adjustment of depth gauge

WARNING

- Do not sand the top part of the bumper tie strap and bumper drive link, nor cause the shape of said parts to deform. (Fig. 38)
- Adjustment of depth gauges must be in line with the predetermined dimensions and shapes, otherwise the risk of kickback may increase, causing an injury.

Depth gauges shall be all lined up in the same manner because they are used to adjust depth at the position where the cutter inlays into the wood.

When sharpening the saw chain, be sure to check the depth gauge every two or three times. (Fig. 39)

Place a depth gauge jointer on the saw chain, leave the gauge visible at the groove, and use a flat file to bevel the portion out of the depth gauge jointer. (Fig. 40) (Depth gauge jointer and flat file are sold separately.)

After filing away the depth gauge, round off the front side of the depth gauge as it was. (Fig. 41)

After sharpening the saw chain, place it into chain oil to wash off the filings.

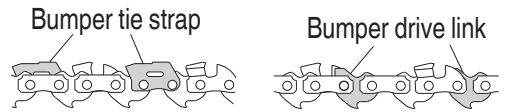

Fig. 38

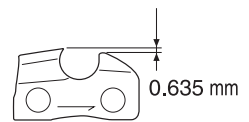

Fig. 39

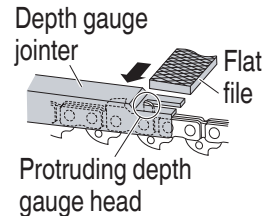

Fig. 40

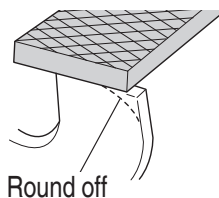

Fig. 41

If filings are not cleaned off, the saw chain and guide bar will quickly wear while in use.

The depth gauge jointer can also be used when dressing with a round file. (Fig. 42)

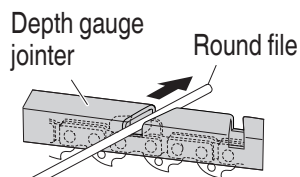

Fig. 42

MAINTENANCE AND INSPECTION

After operation, perform inspection and maintenance of each part when storing the unit.

WARNING

During maintenance and inspection, always switch off the unit and remove the battery from the main body.

CAUTION

Always wear thick gloves when handling the saw chain.

1. Inspection of saw chains
 - Occasionally inspect the saw chain. In the event of any abnormality, replace it with a new one referring to “Installing (replacing) saw chain”.
 - Inspect the chain tension and check if it is correctly tightened.
 - Stop using the unit when the saw chain becomes blunt and sharpen it referring to “Sharpening of the chain blade”.
 - After use, carefully lubricate the saw chain and guide bars with oil for rust-proofing.

NOTE

When cleaning the side cover, sprocket, chain oil spout, and guide bar, see the procedure “Installing (replacing) saw chain” and remove the saw chain.

2. Cleaning the side cover and sprocket (Fig. 43)
Clean and remove any swarf or dust left inside the parts.
3. Cleaning the chain oil spout (Fig. 44)
Before cleaning the chain oil spout, remove the side cover and guide bar.
4. Cleaning the guide bar (Fig. 45)
When sawdust and similar become clogged in the groove of the guide bar or oil spout, the oil may not flow, which may result in the unit failing.
Remove the guide bar and clean any sawdust clogged in the groove after use and when replacing the saw chain. (Refer to “Installing (replacing) saw chain.”)

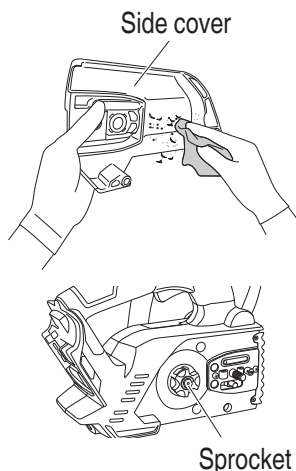

Fig. 43

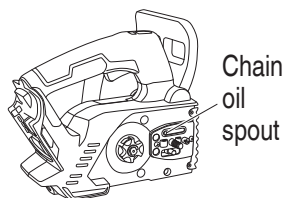

Fig. 44

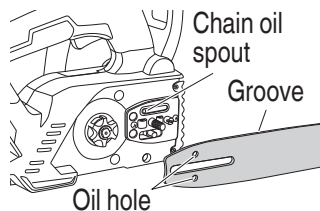

Fig. 45

English

5. **Cleaning the chain brake (Fig. 46)**
Use a brush to remove any swarf from the gap to the saw body.
6. **Inspecting the chain catcher (Fig. 47)**
The chain catcher is designed to protect the operator from being struck by the saw chain if the chain comes loose or is severed.
The chain catcher is integrated into the side cover.
Check to confirm that the chain catcher is not damaged.
7. **Inspecting the mounting screws**
Regularly inspect all mounting screws and ensure that they are properly tightened. Should any of the screws be loose, retighten them immediately. Failure to do so could result in serious hazard.
8. **Maintenance of the motor**
The motor unit winding is the very “heart” of the power tool.
Exercise due care to ensure the winding does not become damaged and/or wet with oil or water.
9. **Cleaning the battery installation compartment and the battery (Fig. 48)**

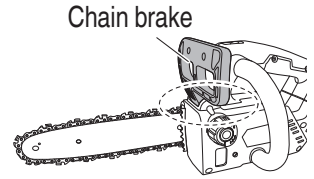

Fig. 46

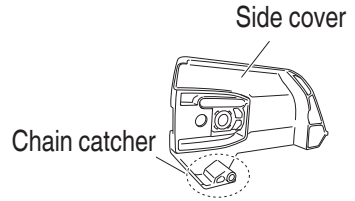

Fig. 47

WARNING

To prevent dust inhalation or eye irritation, wear protective safety goggles and a dust mask when using an air blow gun to clean.

Use a brush or air blow gun to remove any swarf or dust and keep the saw clean.

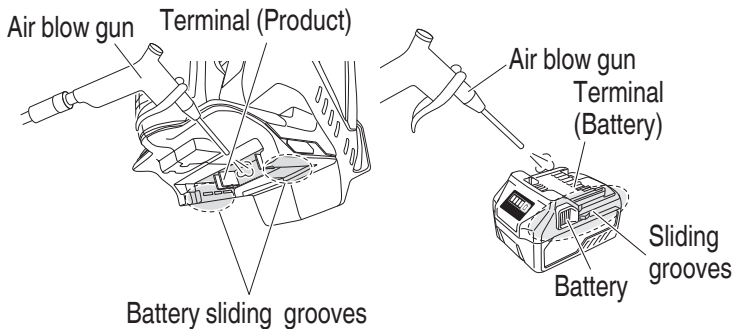

Fig. 48

NOTE

- Allowing swarf and dust to build up during use may cause the battery to fall off or other accidents.
Allowing swarf and dust to build up can also result in malfunctions, including faulty contact between the battery and the terminals.
- After cleaning, check to confirm that the battery can be easily detached and reattached to the tool body.

10. **Cleaning of the outside**
When the power tool is stained, wipe with a soft dry cloth or a cloth moistened with soapy water. Do not use chloric solvents, gasoline or paint thinner, for they melt plastics.
11. **Storage**
 - Clean all parts thoroughly. Coat metal parts with a thin layer of corrosion inhibitor.
 - Be sure to repair any damaged areas before storing.
 - When storing the unit, perform cleaning and maintenance of each part and mount the chain case to the guide bar.
 - Store the power tool and the battery in a place in which the temperature is less than 40°C, and out of reach of children.

NOTE

Storing lithium-ion batteries

Make sure the lithium-ion batteries have been fully charged before storing them.

Prolonged storage (3 months or more) of batteries with a low charge may result in performance deterioration, significantly reducing battery usage time or rendering the batteries incapable of holding a charge.

However, significantly reduced battery usage time may be recovered by repeatedly charging and using the batteries two to five times.

If the battery usage time is extremely short despite repeated charging and use, consider the batteries dead and purchase new batteries.

12. **Service and repairs**
All quality power tools will eventually require servicing or replacement of parts because of wear from normal use. To assure that only authorized replacement parts will be used, all service and repairs must be performed by a HiKOKI AUTHORIZED SERVICE CENTER, ONLY.

CAUTION

In the operation and maintenance of power tools, the safety regulations and standards prescribed in each country must be observed.

Important notice on the batteries for the HiKOKI cordless power tools

Please always use one of our designated genuine batteries. We cannot guarantee the safety and performance of our cordless power tool when used with batteries other than these designated by us, or when the battery is disassembled and modified (such as disassembly and replacement of cells or other internal parts).

TROUBLESHOOTING GUIDE

WARNING

- To avoid injury from an accidental start, turn the switch **OFF** and remove the plug from the power source or remove the battery from the main body before making any adjustments.
- All electrical or mechanical repairs should be done only by qualified service technicians. Contact HiKOKI Authorized Service Center.

Symptom	Possible cause	Remedy
The motor sounds but the saw chain... <input type="radio"/> does not move <input type="radio"/> does not move freely	The chain brake may be activated.	Release by pulling the chain brake toward you.
	The saw chain tension is excessive.	Check the saw chain tension, and if it is too tight, loosen the tension.
	Saw chain comes out of the sprocket.	Check the saw chain is properly engaged on the sprocket.
	Inside the side cover... → sawdust is jammed → foreign matter is trapped	Clean the side cover.
	In the guide bar groove... → sawdust is jammed → oil does not flow	Clean the guide bar groove and the oil hole. Make sure there is oil in the oil tank, and replenish as required.
Poor sharpness	The saw chain... → is worn out or the blade is broken → is rusted	Sharpen the saw chain. If the wear or breakage is very severe, replace with a new saw chain.
	The direction of the saw chain is reversed,	Re-attach ensuring the correct direction.
	Saw chain tension is loose.	Check the saw chain tension and tighten if it is loose.
Chain oil <input type="radio"/> is slow-flowing <input type="radio"/> does not come out (seizes up)	Lack of chain oil in the tank.	Replenish with chain oil.
	Chain oil spout is clogged.	Clean the chain oil spout.
Battery cannot be installed.	Attempting to install a battery other than that specified for the tool.	Please install a multi volt type battery.

SELECTING ACCESSORIES

Select accessories that are suited to a specific task.
For details contact HiKOKI Authorized Service Center.



90PX-040X (3/8 × 10")

90PX-045X (3/8 × 12")



104MLEA041 (10")

124MLEA041 (12")

10" : 379896

12" : 380067

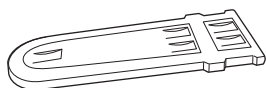

10" : 379898

12" : 377207



957681



6698688

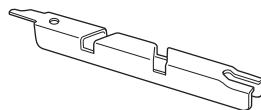

6697724

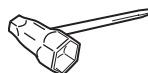

6698582

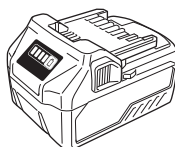

BSL36A18

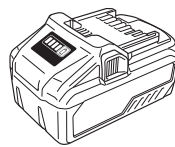

BSL36B18

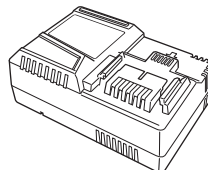

UC18YSL3
(14.4 V-18 V)

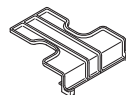

329897

产品中有害物质的名称及含量

部件名称	有害物质					
	铅 (Pb)	汞 (Hg)	镉 (Cd)	六价铬 (Cr(VI))	多溴联苯 (PBB)	多溴二苯醚 (PBDE)
外壳部件	○	○	○	○	○	○
电机部件	○	○	○	○	○	○
开关	×	○	○	○	○	○
电镀部件 (钢叶片等)	○	○	○	○	○	○
传动部件 (齿轮轴等)	○	○	○	○	○	○
电源部件 (电线、引线等)	○	○	○	○	○	○
各种螺丝	○	○	○	○	○	○
铜焊部件 (超硬锯片等)	○	○	○	○	○	○
其它机械部件 (金属件等)	○	○	○	○	○	○
润滑剂 (润滑脂等)	○	○	○	○	○	○
充电器	×	○	○	○	○	○
电池	×	○	×	○	○	○

本表格依据 SJ/T 11364 的规定编制。

○：表示该有害物质在该部件所有均质材料中的含量均在 GB/T26572 规定的限量要求以下。

×：表示该有害物质至少在该部件的某一均质材料中的含量超出 GB/T26572 规定的限量要求。

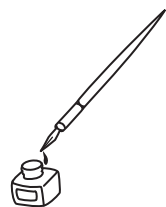

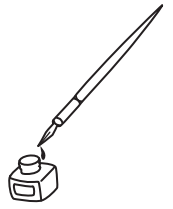

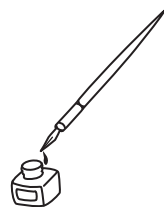

服务中心
高壹工机商业(上海)有限公司
上海市闵行区浦江工业园区三鲁路3585号7幢3楼

制造商
广东高壹工机有限公司
广东省广州市番禺区化龙镇工业路富裕围工业村

Koki Holdings Co., Ltd.

210
编号: C99748521 G
发行日期: 2022年 10月
中国印刷