

HIKOKI

中文
English

充电式角向磨光机
Cordless Disc Grinder

G 1810DA • G 1813DA

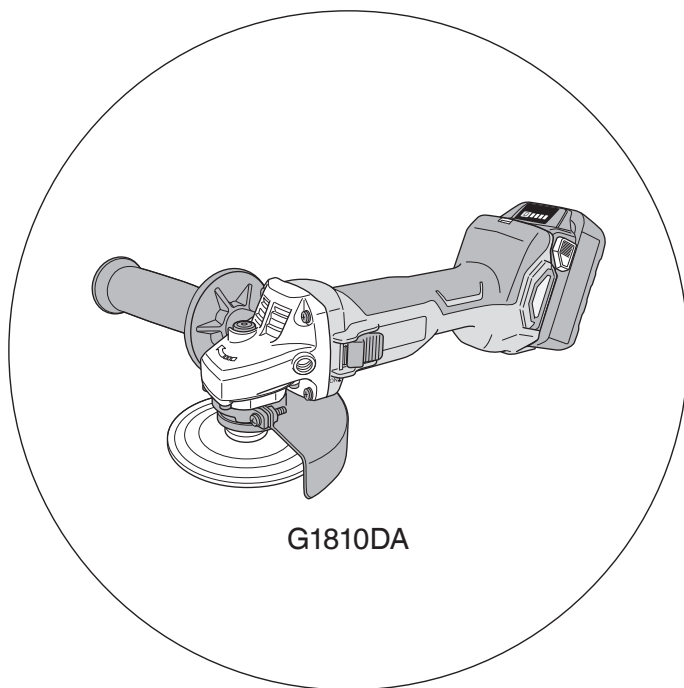

保留备用
Keep for future reference



使用说明书
Handling instructions

目次

电动工具通用安全警告.....	2	零件名称.....	12
砂磨或砂磨切断操作的通用安全警告.....	4	标准附件.....	13
反弹和相关警告.....	6	用途.....	13
砂磨或砂磨切断操作的专用安全警告.....	6	规格.....	14
对砂磨切断操作的附加安全警告.....	7	电池的拆卸 / 安装法.....	15
充电式角向磨光机的一般安全说明.....	7	充电.....	15
其它安全警告.....	8	作业之前.....	18
电池和充电器的使用注意事项.....	9	磨光机的操作.....	20
锂离子电池使用注意事项.....	9	砂轮的组装与分解.....	22
锂离子电池运输.....	11	切割轮和金刚石砂轮的组装和拆卸.....	23
USB 设备连接器使用注意事项 (UC18YSL3).....	11	USB 设备的充电方法.....	24
符号.....	11	维护和检查.....	25
		选择附件.....	28

电动工具通用安全警告

⚠ 警告！

阅读所有警告和所有说明。

不遵照以下警告和说明会导致电击、着火和 / 或严重伤害。

保存所有警告和说明书以备查阅。

在所有下列的警告中术语“电动工具”指市电驱动(有线)电动工具或电池驱动(无线)电动工具。

1) 工作场地的安全

- 保持工作场地清洁和明亮。
混乱和黑暗的场地会引发事故。
- 不要在易爆环境，如有易燃液体、气体或粉尘的环境下操作电动工具。
电动工具产生的火花会点燃粉尘或气体。
- 让儿童和旁观者离开后操作电动工具。
注意力不集中会使操作者失去对工具的控制。

2) 电气安全

- 电动工具插头必须与插座相配。
绝不能以任何方式改装插头。
需接地的电动工具不能使用任何转换插头。
未经改装的插头和相配的插座将减少电击危险。

- b) 避免人体接触接地表面，如管道、散热片和冰箱。
如果你身体接地会增加电击危险。
- c) 不得将电动工具暴露在雨中或潮湿环境中。
水进入电动工具将增加电击危险。
- d) 不得滥用电线。绝不能用电线搬运、拉动电动工具或拔出其插头。
使电线远离热源、油、锐边或运动部件。
受损或缠绕的软线会增加电击危险。
- e) 当在户外使用电动工具时，使用适合户外使用的外接软线。
适合户外使用的软线将减少电击危险。
- f) 如果在潮湿环境下操作电动工具是不可避免的，应使用剩余电流动作保护器（RCD）。
使用RCD可减小电击危险。

3) 人身安全

- a) 保持警觉，当操作电动工具时关注所从事的操作并保持清醒。
当你感到疲倦，或在有药物、酒精或治疗反应时，不要操作电动工具。
在操作电动工具时瞬间的疏忽会导致严重人身伤害。
- b) 使用个人防护装置。始终佩戴护目镜。
安全装置，诸如适当条件下使用防尘面具、防滑安全鞋、安全帽、听力防护等装置能减少人身伤害。
- c) 防止意外起动。确保开关在连接电源和 / 或电池盒、拿起或搬运工具时处于关断位置。
手指放在已接通电源的开关上或开关处于接通时插入插头可能会导致危险。
- d) 在电动工具接通之前，拿掉所有调节钥匙或扳手。
遗留在电动工具旋转零件上的扳手或钥匙会导致人身伤害。
- e) 手不要伸展得太长。时刻注意立足点和身体平衡。
这样在意外情况下能很好地控制电动工具。
- f) 着装适当。不要穿宽松衣服或佩戴饰品。让衣服、手套和头发远离运动部件。
宽松衣服、佩饰或长发可能会卷入运动部件中。
- g) 如果提供了与排屑、集尘设备连接用的装置，要确保它们连接完好且使用得当。
使用这些装置可减少尘屑引起的危险。

4) 电动工具使用和注意事项

- a) 不要滥用电动工具，根据用途使用适当的电动工具。
选用适当设计的电动工具会使你工作更有效、更安全。
- b) 如果开关不能接通或关断工具电源，则不能使用该电动工具。
不能用开关来控制的电动工具是危险的且必须进行修理。
- c) 在进行任何调节、更换附件或贮存电动工具之前，必须从电源上拔掉插头和 / 或使电池盒与工具脱开。
这种防护性措施将减少工具意外起动的危险。

中文

- d) 将闲置不用的电动工具贮存在儿童所及范围之外，并且不要让不熟悉电动工具或对这些说明不了解的人操作电动工具。
电动工具在未经培训的用户手中是危险的。
- e) 保养电动工具。检查运动件是否调整到位或卡住，检查零件破损情况和影响电动工具运行的其他状况。如有损坏，电动工具应在使用前修理好。许多事故由维护不良的电动工具引发。
- f) 保持切削刀具锋利和清洁。
保养良好的有锋利切削刃的刀具不易卡住而且容易控制。
- g) 按照使用说明书，考虑作业条件和进行的作业来使用电动工具、附件和工具的刀头等。
将电动工具用于那些与其用途不符的操作可能会导致危险。

5) 电池式工具使用和注意事项

- a) 只用制造商规定的充电器充电。
将适用于某种电池盒的充电器用到其他电池盒时会发生着火危险。
- b) 只使用配有特制电池盒的电动工具。
使用其他电池盒会发生损坏和着火危险。
- c) 当电池盒不用时，将它远离其他金属物体，例如回形针、硬币、钥匙、钉子、螺钉或其他小金属物体，以防一端与另一端连接。
电池端部短路会引起燃烧或火灾。
- d) 在滥用条件下，液体会从电池中溅出；避免接触。如果无意间碰到了，用水冲洗。如果液体碰到了眼睛，还要寻求医疗帮助。
从电池中溅出的液体会发生腐蚀或燃烧。

6) 维修

- a) 将你的电动工具送交专业维修人员，使用同样的备件进行修理。
这样将确保所维修的电动工具的安全性。

注意！

不可让儿童和体弱人士靠近工作场所。

应将不使用的工具存放在儿童和体弱人士接触不到的地方。

砂磨或砂磨切断操作的通用安全警告

- a) 该电动工具是用于实现砂轮机或切断工具功能的。阅读随该电动工具提供的所有安全警告、说明、图解和规定。
不了解以下所列所有说明将导致电击、着火和/或严重伤害。
- b) 不推荐用该电动工具进行诸如砂光、抛光或刷光等操作。
电动工具不按指定的功能去操作，可能会发生危险和引起人身伤害。
- c) 不使用非工具制造商推荐和专门设计的附件。
否则该附件可能被装到你的电动工具上，而它不能保证安全操作。

- d) 附件的额定速度必须至少等于电动工具上标出的最大速度。
附件以比其额定速度大的速度运转会发生爆裂和飞溅。
- e) 附件的外径和厚度必须在电动工具额定能力范围之内。
不正确的附件尺寸不能得到充分防护或控制。
- f) 配件螺纹安装必须与磨床主轴螺纹相匹配。通过法兰安装配件时，配件的轴孔必须适合法兰的定位直径。
如果配件与动力工具的装载硬件不匹配，可能导致工具失去平衡、剧烈振动和失去控制。
- g) 不要使用损坏的附。在每次使用前要检查附件，例如砂轮是否有碎片和裂缝，靠背垫是否有裂缝、撕裂或过度磨损，钢丝刷是否松动或金属丝是否断裂。如果电动工具或附件跌落了，检查是否有损坏或安装没有损坏的附件。检查和安装附件后，让自己和旁观者的位置远离旋转附件的平面，并以电动工具最大空载速度运行1分。
损坏的附件通常在该试验时会碎裂。
- h) 戴上防护用品。根据适用情况，使用面罩、安全护目镜或安全眼镜。适用时，戴上防尘面具、听力保护器、手套和能挡小磨料或工件碎片的工作围裙。
眼防护罩必须挡住各种操作产生的飞屑。防尘面具或口罩必须能过滤操作产生的颗粒。长期暴露在高强度噪声中会引起失聪。
- i) 让旁观者与工作区域保持一安全距离。任何进入工作区域的人必须戴上防护用品。
工件或破损附件的碎片可能会飞出并引起紧靠着操作区域的旁观者的伤害。切割附件触及带电导线会使电动工具外露的金属零件带电，并使操作者触电。
- j) 当在切割工具有可能碰到暗线的场所进行操作时，只能通过绝缘握持面来握住电动工具。
碰到一根带电导线可能会使电动工具的外露金属零件带电并使操作者发生电击危险。
- k) 使软线远离旋转的附件。
如果控制不当，软线可能被切断或缠绕，并使得你的手或手臂可能被卷入旋转附件中。
- l) 直到附件完全停止运动才放下电动工具。
旋转的附件可能会抓住表面并拉动电动工具而让你失去对工具的控制。
- m) 当携带电动工具时不要开动它。
意外地触及旋转附件可能会缠绕你的衣服而使附件伤害身体。
- n) 经常清理电动工具的通风口。
电动机风扇会将灰尘吸进机壳，过多的金属粉末沉积会导致电气危险。
- o) 不要在易燃材料附件操作电动工具。
火星可能会点燃这些材料。
- p) 不要使用需用冷却液的附件。
用水或其他冷却液可能会导致电腐蚀或电击。

反弹和相关警告

反弹是因卡住或缠绕住的旋转砂轮、靠背垫、钢丝刷或其他附件而产生的突然反作用力。卡住或缠绕会引起旋转附件的迅速堵转，随之使失控的电动工具在卡住点产生与附件旋转方向相反的运动。

例如，如果砂轮被工件缠绕或卡住，伸入卡住点的砂轮边缘可能会进入材料表面而引起砂轮爬出或反弹。砂轮可能飞向或飞离操作者，这取决于砂轮在卡住点的运动方向。在此条件下砂轮也可能碎裂。

反弹是电动工具误用和 / 或不正确操作工序或条件的结果，可以通过采取以下给出的适当预防措施得以避免。

- a) 保持紧握电动工具，使你的身体和手臂处于正确状态以抵抗反弹力。如有辅助手柄，则要一直使用，以便最大限度控制住起动时的反弹力或反力矩。
如采取合适的预防措施，操作者就可以控制反力矩或反弹力。
- b) 绝不能将手靠近旋转附件。
附件可能会反弹碰到手。
- c) 不要站在发生反弹时电动工具可能移动到的地方。
反弹将在缠绕点驱使工具逆砂轮运动方向运动。
- d) 当在尖角、锐边等处作业时要特别小心。避免附件的弹跳和缠绕。
尖角、锐边和弹跳具有缠绕旋转附件的趋势并引起反弹的失控。
- e) 不要附装上锯链、木雕刀片或带齿锯片。
这些锯片会产生频繁的反弹和失控。

砂磨或砂磨切断操作的专用安全警告

- a) 只使用所推荐的砂轮型号和为选用砂轮专门设计的护罩。
不是为电动工具设计的砂轮不能充分得到防护，是不安全的。
- b) 中央凹陷磨轮的磨削面必须安装在护刃器唇平面的下方。
磨轮安装不正确，通过护刃器唇平面的操作无法得到妥善保护。
- c) 护罩必须牢固地装在电动工具上，且放置得最具安全性，只有最小的砂轮部分暴露在操作人面前。
护刃器有助于保护操作员免受破损磨轮碎片、意外接触磨轮和引燃衣物火花的伤害。
- d) 砂轮只用作推荐的用途。例如：不要用切割砂轮的侧面进行磨削。
施加到砂轮侧面的力可能会使其碎裂。
- e) 始终为所选砂轮选用未损坏的、有恰当规格和形状的砂轮法兰盘。
合适的砂轮法兰盘支承砂轮可以减小砂轮破裂的可能性。切割砂轮的法兰盘可以不同于砂轮法兰盘。
- f) 不要使用从大规格电动工具上用剩的磨损砂轮。
用于大规格电动工具上的砂轮不适于较小规格工具的高速工况并可能会爆裂。

对砂磨切断操作的附加安全警告

- a) 不要“夹”住切割砂轮或施加过大的压力。不要试图做过深的切割。
给砂轮施加过应力增加了砂轮在切割时的负载，容易缠绕或卡住，增加了反弹或砂轮爆裂的可能性。
- b) 身体不要对着旋转砂轮，也不要站在其后。
当把砂轮从操作者身边的操作点移开时，可能的反弹会使旋转砂轮和电动工具朝你推来。
- c) 当砂轮被卡住或无论任何原因而中断切割时，关掉电动工具并握住工具不要动，直到砂轮完全停止。决不要试图当砂轮仍然运转时使切割砂轮脱离切割，否则会发生反弹。
调查并采取校正措施以消除砂轮卡住的原因。
- d) 不能在工件上重新启动切割操作。让砂轮达到全速后再小心地重新进入切割。
如果电动工具在工件上重新启动，砂轮可能会卡住，爬出或反弹。
- e) 支撑住板材或超大工件可使得砂轮卡住和反弹的危险降到最低限度。
大工件凭借自重而下垂。必须在工件靠近切割线处和砂轮两侧近工件边缘处放置支承。
- f) 当进行“盲切割”进入墙体或其他盲区时要格外小心。
伸出的砂轮可能会割到煤气管或水管，电线或由此引起反弹的物体。

充电式角向磨光机的一般安全说明

- 确认砂轮上所标示的转速等于或大于角磨机的额定转速；
- 确保砂轮尺寸与角磨机相符；
- 须按照厂家的使用说明书小心存放和使用磨轮；
- 使用前检查砂轮，不要使用破损、有裂缝或有其他缺陷的产品；
- 确保所安装的砂轮和节点已按照厂家的使用说明固定；
- 确保使用随研磨产品附带的吸油纸或在需要时使用吸油纸；
- 在使用前确保已正确安装并拧紧研磨产品，并在安全场所在空载状态下运转 30 秒钟，若有较大的振动或察觉到其他缺陷，则应立即停止运转。遇此情况时，检查电动工具以究明原因；
- 若电动工具配备保护装置，切勿在未使用此保护装置时使用电动工具；
- 使用切割砂轮时，请务必拆下标准附件砂轮保护装置，并装上带侧护板（另售）的砂轮保护装置（第 22, 23 页的图 14, 15）；
- 请勿将独立的减速轴衬或接头，以便使用大孔砂轮；
- 有关要用螺纹孔砂轮来安装的工具，确保砂轮的螺纹足够长，以适合轴长；
- 检查工件已被正确固定；
- 请勿使用切断砂轮进行侧面研磨；
- 确保使用时产生的火花不会引起危险，例如不要溅在身体上或点燃易燃物；

中文

- 在多尘的条件下工作时，确保通风口畅通无堵塞现象。如果需要清除灰尘，首先使电动工具断开电源（使用非金属物品）并避免损坏内部零件；
- 始终采用视力和听力保护。必须使用其他个人保护装置，如口罩、手套、头盔和围裙等。
- 在切断本电动工具的电源之后，砂轮仍会继续旋转一段时间，请注意此事项。
- 勿让杂质进入充电式电池连结口内。
- 切勿拆卸充电式电池与充电器。
- 切勿使充电式电池短路。使电池短路将会造成很大的电流和过热，从而烧坏电池。
- 请勿将电池丢入火中。
电池受热将会爆炸。
- 请勿将异物插入充电器的通风口。
若将金属异物或易燃物插入通风口的话，将会引起触电事故或使充电器受损。
- 充电后电池寿命太短不够使用时，请尽快将电池送往经销店。请勿将用过的电池乱丢。

⚠ 警告！

- 使用切割轮时，请务必安装切割防护装置。
- 使用砂轮时，请务必安装砂轮护罩。

其它安全警告

1. 确保要使用的砂轮属于正确类型、没有裂纹或表面缺陷。同时也要确认砂轮装好，轮螺母紧固。
2. 接通电动工具的电源之前按两下按钮，检查按钮是否会释放。
3. 本机不可施加过大压力使其过载，这样才能延长机器的使用寿命并确保加工质量。在大部分的用法中，机器本身的重量即够研磨。加压过大将导致转速降低、表面加工不良以及过载，从而使机器寿命缩短。
4. 在切断本电动工具的电源之后，砂轮仍会继续旋转一段时间。
关掉机器之后，需等角向磨光机完全停止才能将其放下，以免造成严重事故，而且还可以减少吸入机器的尘埃及切屑量。
5. 装卸锥形砂轮前，确保开关处于“关闭（OFF）”状态，并拔出电池，以避免严重事故。
6. 请小心制动器反弹。
此款充电式角向磨光机配备了电力制动器，可以在松开开关时发挥作用。制动器发挥作用时，可能会出现反弹现象，因此请务必牢牢握住机身。
7. 请勿使用工具或电池端子（电池安装部位）明显变形的产品。
否则，安装电池后可能会短路，造成冒烟或起火。

8. 请清除工具端子（电池安装部位）上的削屑和灰尘。
 - 使用前请确保电池上没有堆积削屑和灰尘。
 - 在使用过程中，请尽量避免工具上的削屑或灰尘掉落在电池上。
 - 暂时不使用工具时或使用后，应将工具存放在不会掉落削屑或灰尘的地方。否则可能短路，造成冒烟或起火。

电池和充电器的使用注意事项

1. 请始终在 -10 至 40°C 的环境温度下对电池进行充电。温度低于 -10°C 将导致危险的过充电。不得在高于 40°C 的温度下对电池进行充电。
最适于充电的温度是 20 至 25°C。
2. 请勿连续使用充电器。
充电结束后，在下次充电之前请将充电器放置约 15 分钟。
3. 勿让杂质进入可充电电池的连接口内。
4. 切勿拆卸可充电电池或充电器。
5. 切勿使可充电电池短路。
使电池短路将会造成很大的电流和过热，从而烧坏电池。
6. 请勿将电池丢入火中。
电池受热将会爆炸。
7. 使用耗尽的电池会损坏充电器。
8. 充电后的电池寿命太短不够使用时，请尽快将本电池送往购买时的经销店。
请勿将用过的电池乱丢。
9. 请勿将异物插入充电器的通风口。
将金属物体或易燃物插入充电器的通风口会导致触电事故或损坏充电器。

锂离子电池使用注意事项

为延长使用期限，锂离子电池备配停止输出的保护功能。

若是在使用本产品时发生下列 1 至 3 的情况，即使按下开关，马达也可能停止。这并非故障，而是启动保护功能的结果。

1. 在残留的电池电力即将耗尽时，马达会停止。
在这种情况下，请立即予以充电。
2. 若工具超过负荷，马达亦可能停止。在这种情况下，请松开工具的开关，试着消除超过负荷的原因。之后您就可以再度使用。
3. 若电池在过载工作情况下过热，电池电力可能会中止。
在这种情况下，请停止使用电池，让电池冷却。之后您就可以再度使用。

此外，请留心下列的警告及注意事项。

警告！

为防止发生电池漏电、发热、冒烟、爆炸及提前点燃，请确保留意下列事项。

中文

1. 确保电池上没有堆积削屑及灰尘。
 - 在工作时确定削屑及灰尘没有掉落在电池上。
 - 确定所有工作时掉落在电动工具上的削屑和灰尘没有堆积在电池上。
 - 请勿将未使用的电池存放在曝露于削屑和灰尘的位置。
 - 在存放电池之前，请清除任何可能附着在上面的削屑和灰尘，并请切勿将它与金属零件（螺丝、钉子等）存放在一起。
2. 请勿以钉子等利器刺穿电池、以铁锤敲打、踩踏、丢掷电池，或将其剧烈撞击。
3. 切勿使用明显损坏或变形的电池。
4. 请依规定方式使用电池，切勿移作他用。
5. 如果已过了再充电时间，电池仍无法完成充电，请立即停止继续再充电。
6. 请勿将电池放置于高温或高压处，例如微波炉、烘干机或高压容器内。
7. 在发觉有渗漏或异味时，请勿接近远离火源。
8. 请勿在会产生强烈静电的地方使用。
9. 如有电池渗漏、异味、发热、褪色或变形，或在使用、充电或存放时出现任何异常，请立即将它从装备或电池充电器拆下，并停止使用。
10. 请勿浸泡电池或让任何液体流入电池内部。导电液体进入（如水），可能造成电池损坏，甚至可导致火灾或爆炸。将电池存放在阴凉、干燥的地方，远离易燃物品。必须避免将电池置于腐蚀性气体环境中。

注意！

1. 若电池渗漏出的液体进入您的眼睛，请勿搓揉眼睛，并以自来水等干净清水充分冲洗，立刻送医。
若不加以处理，液体可能会导致眼睛不适。
2. 若液体渗漏至您的皮肤或衣物，请立即以自来水等清水冲洗。
上述情况可能会使皮肤受到刺激。
3. 若初次使用电池时发现生锈、异味、过热、褪色、变形及 / 或其它异常情况时，请勿使用并将该电池退还给供货商或厂商。

警告！

如果导电异物进入锂离子电池端子之间，可能发生短路，并造成火灾危险。存放电池时，请遵循下列事项。

- 请勿在存储盒中放入导电的切屑、铁钉、钢丝、铜线或其他导线。
- 或者将电池装在电动工具中，或者在牢固按入电池盖并挡住通风孔后再存放，以防止短路（参照图1）。



图 1

锂离子电池运输

当运输一个锂离子电池，请注意以下预防措施。

警告！

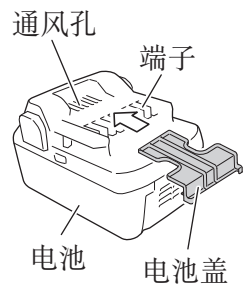
告知运输公司，包装内包含一个锂离子电池，告知该公司其功率输出并且要按照运输公司的指引安排运输。

- 功率输出超过100Wh的锂离子电池被视作危险物品运输分类并且需要特别申请程序。(图2)
- 对于境外运输，您必须遵守国际法以及输入国的规章和条例。



图 2

USB设备连接器使用注意事项(UC18YSL3)

发生意外情况时，本产品连接的 USB 中保存的数据可能发生损坏或丢失。使用本产品前，请务必备份 USB 设备中的数据。

请注意，如 USB 设备中存储的数据发生损坏、丢失或连接的设备发生损坏，本公司概不负责。

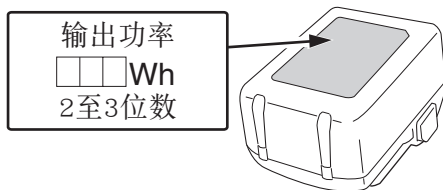
警告！

- 使用之前请检查 USB 连接线缆是否有破损或损坏。
使用有破损或损坏的 USB 线缆可能会导致冒烟或着火。
- 不使用产品时，请用橡胶盖封好 USB 端口。
USB 端口中落入灰尘等可能会导致冒烟或着火。

注：

- USB 充电过程中，可能会有偶尔暂停。
- USB 设备未充电时，请将充电器上拔下 USB 设备。
否则不仅会减少 USB 设备的电池寿命，还会导致意外事故。
- 根据设备类型，可能无法对部分 USB 设备进行充电。

符号

警告！

如下所示的符号用于本机。使用前请务必理解其含意。

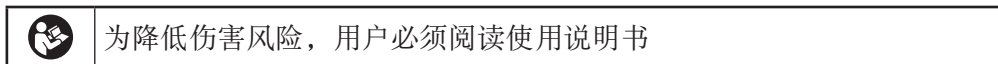

零件名称

1. 电动工具



图 3

2. 电池 (选购件)

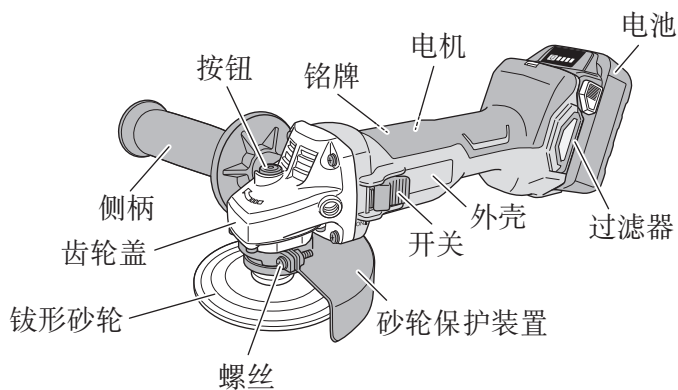
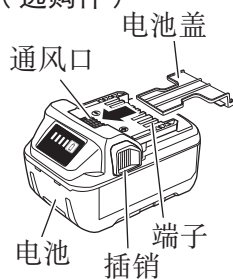

<BSL1850MA>

图 4

3. 电池充电器 (选购件)

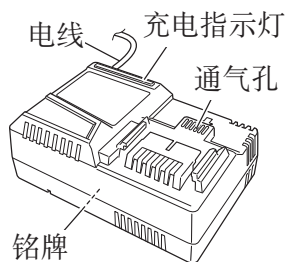

<UC18YSL3>

图 5

标准附件

除了主机（1 台）外，产品包中还包括表中所列的附件。

表 1

	G1810DA	G1813DA
	(NNP)	(NNP)
 钹形砂轮	1	1
 扳手 (100 mm)	1	—
 扳手 (125 mm)	—	1
 侧柄	1	1
 可堆叠外壳	1	1

用途

- 用于去除铸品毛刺，飞边等物及抛光各种型号的钢、青铜、铝及铸造品。
- 研磨焊接部分或研磨用焊开的部分。
- 合成树脂、石板、砖、大理石等的研磨。
- 混凝土、石头、砖、大理石等的切削。

规格

电动工具

型式		G1810DA	G1813DA
电压		18V	
空载转速	传输模式	8000r/min	
砂轮	外径	100mm	125mm
	厚度	6mm	6mm
	穴径	16mm	22.23mm
	圆周速度	72m/s	80m/s
电池		BSL1850MA: 锂离子 18V (5.0Ah 10 节)	
重量		2.4kg (BSL1850MA)	2.6kg (BSL1850MA)
		2.8kg (BSL36B18)	2.9kg (BSL36B18)

注：

HiKOKI 将不断研究和研发新产品，因此，如规格发生变更，恕不另行通知。

电子控制

○ 缓慢启动

通过调节启动时的转数来减轻对操作者的反冲力。

○ 反冲保护

反冲保护功能可在操作过程中轮转速突然下降时（如在切割操作期间轮锁定等）切断电机电源并停止电动工具。

○ 过载保护

在操作过程中，如果电机过载，此保护功能可以断开电机电源，明显降低转速。过载保护功能激活时，电机会停止。

在这种情况下，请松开工具的开关，试着消除过载的原因。

然后再重新使用。

○ 过热保护

在操作过程中，如果电机过热，此保护功能可以断开电机电源，使电动工具停止运行。

过热保护功能激活时，电机会停止。

在这种情况下，请松开工具的开关，冷却数分钟。

然后再重新使用。

○ 防重启功能

电源为接通状态时，该工具在安装电池后也不会重启。切断工具电源后，该功能就会取消。

充电器

型式	UC18YSL3
充电电压	14.4V-18V
重量	0.6kg

电池的拆卸 / 安装法

1. 电池的拆卸法

请先紧抓住把手、然后再推压电池插销以拆下电池（参照图 6）。

注意！

切勿使电池短路。

2. 电池的安装法

插入电池时请注意极性（参照图 6）



图 6

充电

使用电动工具之前，按下述方法将电池进行充电。

1. 将充电器的电源线连接到插座。

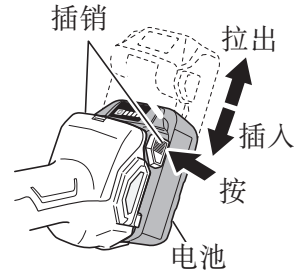
将充电器插头连接到插座时，充电指示灯闪烁红色（间隔为 1 秒）。

2. 将电池插入充电器。

如图 7 所示，将电池紧紧地插入充电器。

3. 充电

将电池插入充电器后，充电指示灯将呈蓝色闪烁。

电池完全充电后，充电指示灯将持续点亮呈绿色。（参照 第 16 页的表 2）









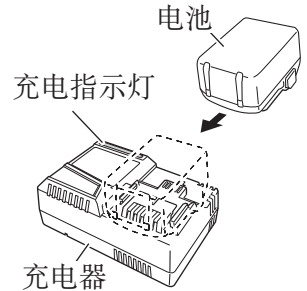

图 7

中文

(1) 充电指示灯的指示状态

根据充电器或可充电电池的情况，充电指示灯的显示如 表 2 所示。

表 2

充电指示灯的指示状态				
充电指示灯 (红 / 蓝 / 绿 / 紫)	充电前	闪烁 (红)	点亮 0.5 秒钟。不点亮 0.5 秒钟。(熄灭 0.5 秒钟) 	插入电源 *1
	充电时	闪烁 (蓝)	点亮 0.5 秒钟。不点亮 1 秒 钟。(熄灭 1 秒钟) 	电池电量低于 50%
		闪烁 (蓝)	点亮 1 秒钟。不点亮 0.5 秒钟。(熄灭 0.5 秒钟) 	电池电量低于 80%
		点亮 (蓝)	连续点亮 	电池电量高于 80%
	充电完成	点亮 (绿)	连续点亮  (发出持续蜂鸣声：约 6 秒)	
	过热 待机	闪烁 (红)	点亮 0.3 秒钟。不点亮 0.3 秒钟。(熄灭 0.3 秒钟) 	电池过热。无法充 电 (电池冷却后将 开始充电) *2
	无法 充电	闪动 (紫色)	点亮 0.1 秒钟。不点亮 0.1 秒钟。(熄灭 0.1 秒钟)  (发出断续蜂鸣声：约 2 秒)	电池或充电器故障 *3

*1 如果连好充电器后指示灯依旧闪烁红色，请检查并确认电池已完全插入。

*2 虽然继续放置在原处，电池将在冷却后开始充电，但最好是将电池取出并放置在阴凉、通风良好的位置处冷却。

*3

○ 请紧紧插入电池。

○ 检查并确认电池安装部位或端部无异物堵塞。

< 充电时间较长 >

○ 环境温度过低时，充电时间会延长。请在温暖的场所中(如室内)给电池充电。

○ 请勿堵塞排气孔。否则会导致内部过热，从而降低充电器的性能。

○ 如果冷却扇未运转，请联系 HiKOKI 授权服务中心进行维修。

(2) 可充电电池温度和充电时间相关资料。
温度和充电时间如表 3 所示

表 3

电池		充电器	UC18YSL3
电池类型			锂离子电池
充电电压			14.4–18V
电池可充电温度			0°C–50°C
充电时间，电池容量， 约为 (20°C)		1.5Ah	15 分钟
		2.0Ah	20 分钟
		2.5Ah	25 分钟
		3.0Ah	20 分钟 (BSL1430C、BSL1830C: 30 分钟)
		4.0Ah	26 分钟 (BSL1840M: 40 分钟)
		5.0Ah	32 分钟
		6.0Ah	38 分钟
		8.0Ah	52 分钟
	多伏电池	1.5Ah (×2 节)	20 分钟
		2.5Ah (×2 节)	32 分钟
	4.0Ah (×2 节)	52 分钟	
电池数量			4–10
USB 充电电压			5V
USB 充电电流			2A
重量			0.6kg

注：

充电时间可能会因环境温度和电源电压而异。

中文

4. 从电源插座拔下充电器的电源线。

5. 握紧充电器并取出电池。

注：

充电后，先将电池从充电器中取出，然后妥善保存。

关于新电池的放电。

新电池内部的化学物质未被激活或电池长时间不使用时，初次或第二次使用时需要将其放电至较低电量。这只是暂时现象，将电池充电 2-3 次即可恢复为充电所需的正常时间。

较长时间保持电池性能的方法

(1) 在电池电力完全耗尽之前进行充电。

感到电动工具的能力变弱时，请停止使用并给电池充电。若您继续使用电动工具并耗尽电力，电池可能会损坏或其使用寿命缩短。

(2) 避免在高温环境中充电。

使用后可充电电池的温度将迅速升高。若使用后立即对这种电池进行充电，其内部化学物质会劣化，电池使用寿命将缩短。请稍等片刻，待电池冷却后再进行充电。

注意！

- 如果电池长时间放置在阳光直射的地方或者刚刚使用完毕时，电池会发热。如果此时对电池充电，充电器的充电指示灯会点亮 0.3 秒钟，然后熄灭 0.3 秒钟（熄灭 0.3 秒钟）。此时请等待电池冷却后再开始充电。
- 充电指示灯闪动（闪动间隔为 0.2 秒钟）时，请检查充电器的电池连接器内是否有异物并加以清除。如没有异物，则可能是电池或充电器发生了故障。请将其送往当地授权服务中心。

作业之前

1. 电源开关

确保开关处于关闭（OFF）位置。

2. 工作环境的检查

在作业之前，确认如下各点：

- 工作场所无易燃气体、液体或者物件。
- 在研磨薄钢板的时候，可能会导致较大的轰鸣声。
为了消除此类噪声，请在工件下方放置一个橡胶垫。
- 清场，确保无儿童或者未经授权的人员。

3. 安装并调整轮罩

轮罩是一种保护装置用来防止作业中因砂轮破裂而受伤。开始研磨作业之前，请确认轮罩是否安装得紧固妥善。

[安装和调节砂轮保护装置的方法](图 8)

- 轻微松开轮罩上的螺丝。
- 将轮罩装在密封压盖上，转动到适合操作的角度，并进行调整。
- 调整后，确保拧紧轮罩上的螺丝，以便将其完全固定。



图 8

4. 在安装之前请彻底检查，确保钹形砂轮无裂纹、裂口和其他的缺陷。

确保砂轮已安装恰当，且紧固。请参见本手册第 22 页，了解“砂轮的组装与分解”。

5. 磨光机的试行运转

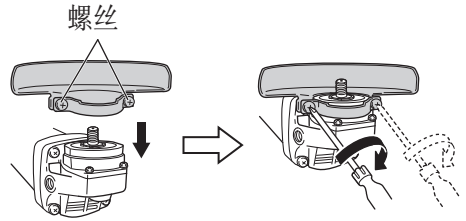
在实际开始研磨工作之前，首先清场，确保无其他人员，然后开始测试磨光机。确保已安装了轮罩，且您佩戴了护目用具。打开磨光机，然后确保磨光机平稳运转，且无异常。

试行运转的持续时间如下所示：

在更换钹形砂轮的时候.....3 分钟或以上

在开始日常操作的时候.....1 分钟或以上

6. 请仅使用额定值适当的钹形砂轮。请仅使用额定值在 13300r/min 或以上的钹形砂轮。

7. 检查按钮。

在开启磨光机之前按两下按钮，检查它是否已被释放。(图 9)。



图 9

8. 剩余电池电量指示灯

可以按下剩余电池电量指示灯开关点亮指示灯，查看电池的剩余电量。(图 10, 第 20 页的表 4)

按住剩余电池电量指示灯开关约 3 秒后，指示灯将熄灭。

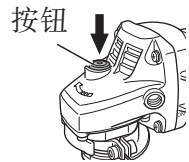
环境温度和电池状态可能会对剩余电池电量产生轻微的影响，因此，建议您仅将指示灯作为参考。

此外，电动工具或充电器上的剩余电池电量指示灯可能有所不同。

(本产品不附带电池。)

剩余电池电量指示灯 剩余电池电量指示灯开关









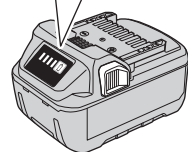

图 10

表 4

指示灯状态	电池剩余电量
	点亮； 电池剩余电量超过 75%
	点亮； 电池剩余电量为50%—75%
	点亮； 电池剩余电量为25%—50%
	点亮； 电池剩余电量不到 25%
	闪烁； 电池剩余电量即将耗尽。请尽快对电池进行充电。
	闪烁； 因高温暂停输出从电动工具中取下电池，让电池完全冷却。
	闪烁； 因失败或故障暂停输出。电池可能出现故障，请与经销商联系。

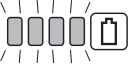
因为电池余量指示因环境温度和电池特性而略有不同，上表仅供参考。

注：

请勿对开关面板施加强烈冲击或将其损坏，否则可能会导致故障。

磨光机的操作

注意！

为了延长使用寿命，锂离子电池应具有停止输出的保护功能。以在工具过载的情况下，马达可以停止运行。不过，这不是问题，重点是保护功能的结果。在这种情况下，将释放工具开关，并消除导致过载的原因。

注：

- 为防止受伤，本产品有一项功能，可防止在插入电池时马达意外旋转。当开关处于开启（ON）位置时，如果插入电池，马达将不运转。安装电池后，将开关转到关闭（OFF）位置，然后重新转回到开启（ON）位置。
- 这些型号均配备有保护功能，一旦过载，将通过该功能关闭工具。一旦工具因为过载而关闭，可以关闭然后重新打开电源。

过载会导致工具停止运转并保持超过10秒的时间，在此时间内，将无法通过关闭电源然后开启来重新运转工具。如果发生这种情况，可以拆下工具的电池，然后重新装上，之后打开电源开关即可。

1. 紧紧地握住磨光机的外罩和侧把手（图 11）。

磨光机将产生一种反作用力，必须通过紧紧地握住磨光机才能控制住这种应力。



图 11

2. 开启磨光机。（图 12）

要启动工具时，请先按下开关的后部，然后往前推开关。

需要将开关保持在开启（ON）位置时，请推开关头以锁定在开启（ON）位置。

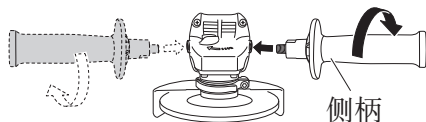
要释放开关至关闭（OFF）位置时，请推开关的后部。



图 12

3. 使用轻松的研磨压力。

研磨时无需用力。通常磨光机的自身重量足以以轻触表面方式进行研磨。

警告！

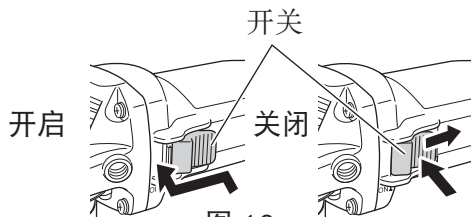
不要强力按磨光机对表面进行研磨。重压会导致砂轮破损并且损坏。它也能损坏研磨的表面以及损坏磨光机的马达。

4. 使用适当的研磨角。

只能通过抬起磨光机砂轮边缘倾至 15° — 30° 进行研磨，如图 13 所示。

注意！

不能使用锥形砂轮整个表面。只能使用锥形砂轮的边缘。



图 13

5. 按正确的方向移动磨光机

当按方向A（图 13）使用一个新的锥形砂轮时，砂轮边缘可以切入工件。在这种情况下，按研磨方向B（图 13）进行研磨。一旦砂轮边缘磨损时，可按两个方向研磨工件。

注：

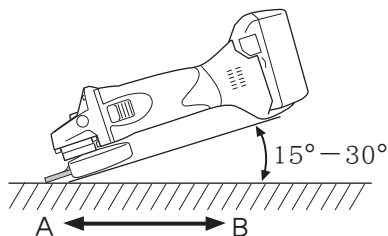
所供砂轮（树脂胶结砂轮）属于A级粒以及 # 36 粒度。它最适合用于钢铁和其它类型材料的强力磨削。

6. 调整操作所需的光洁度。

对于精加工，稍微抬起以减少压力。以适当的速度缓慢研磨。

注意！

旋转钹形砂轮将产生乱流。在磨光机完全停止运转之前，切勿将磨光机放在有灰尘或者尘垢的区域上。

砂轮的组装与分解（图 14）

警告！

请务必关闭开关并取出电池。

1. 组装

(1) 将角向磨光机的上部朝下，以使主轴朝上。

(2) 将砂轮垫圈 (A) (G1810DA) 或砂轮垫圈 (C) (G1813DA) 的十字平面对准主轴的缺口部分，然后装上。

(3) 将钹形砂轮的突起部安装在砂轮垫圈 (A) 或 (C) 上。

(4) 将砂轮螺帽拧在主轴上。

(5) 用一只手按下按钮，同时用另一只手慢慢地转动砂轮以卡紧主轴。

如图 14 所示，用附带的扳手拧紧砂轮螺帽。



图 14

2. 分解

分解顺序与安装顺序相反。

注意！

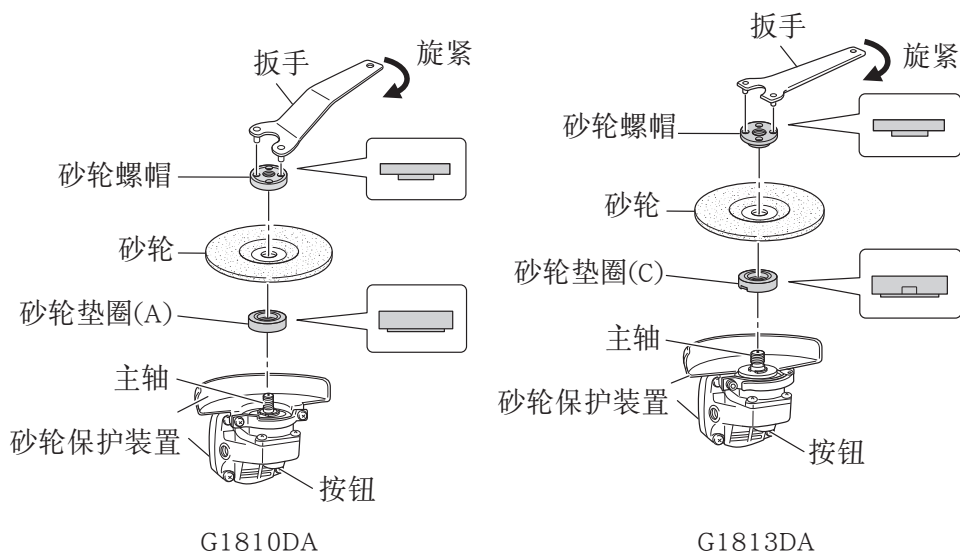
- 请确认砂轮是否安装紧固。
- 请在打开电源开关之前，按两下按钮，以确认按钮是否已被释放。

切割轮和金刚石砂轮的组装和拆卸（图15）**警告！**

请务必关闭开关并取出电池。

1. 组装

- (1) 将角向磨光机的上部朝下，以使主轴朝上。
- (2) 将砂轮垫圈 (A) (G1810DA) 或砂轮垫圈 (C) (G1813DA) 的十字平面对准主轴的缺口部分，然后装上。
- (3) 将切割轮和金刚石砂轮安装在砂轮垫圈 (A) 或 (C) 上。
- (4) 将砂轮螺帽拧在主轴上。
- (5) 用一只手按下按钮，同时用另一只手慢慢地转动砂轮以卡紧主轴。

如图 15 所示，用附带的扳手拧紧砂轮螺帽。



图 15

中文

2. 分解

分解顺序与安装顺序相反。

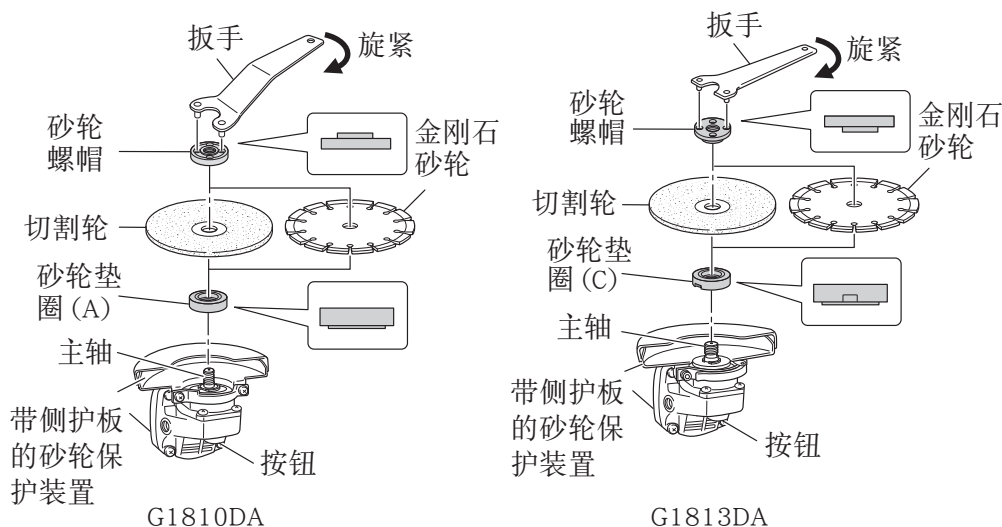
注意！

- 请确认砂轮是否安装紧固。
- 请在打开电源开关之前，按两下按钮，以确认按钮是否已被释放。

注：

- 使用工具时，请避免通过更改馈送率来过度用力。
- 切割轮的轮罩将产生磨削火花，使温度大幅升高。请勿在操作时触摸轮罩。

USB设备的充电方法

警告！

- 使用之前请检查 USB 连接线缆是否有破损或损坏。
使用有破损或损坏的 USB 线缆可能会导致冒烟或着火。
- 不使用产品时，请用橡胶盖封好 USB 端口。
USB 端口中落入灰尘等可能会导致冒烟或着火。

注：

- USB 充电过程中，可能会有偶尔暂停。
- USB 设备未充电时，请将充电器上拔下 USB 设备。
否则不仅会减少 USB 设备的电池寿命，还会导致意外事故。
- 根据设备类型，可能无法对部分 USB 设备进行充电。

(1) 选择充电方式

根据所选的充电方式，将电池插入充电器或连接电源线插入插座。

- 将 USB 设备插入插座进行充电（图 16-a）。
- 将 USB 设备和电池插入插座进行充电。（图 16-b）



图 16

(2) 连接 USB 线缆。(图 17)

拔下橡胶盖并将市售的 USB 线缆（匹配充电的设备）紧紧插入 USB 端口。

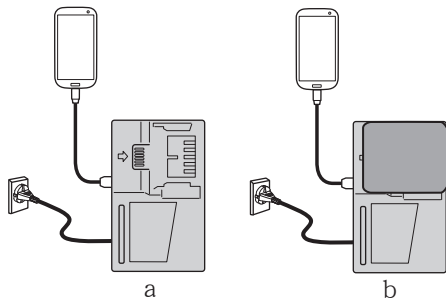

图 17

(3) 充电完成时

○ 检查 USB 设备以检验充电状态。

○ 从插座中拔下电源线。(图 18)

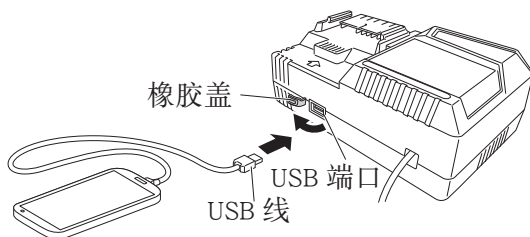
○ 用橡胶盖盖住 USB 端口。



图 18

维护和检查

警告！

○ 确保关闭开关并取出电池。

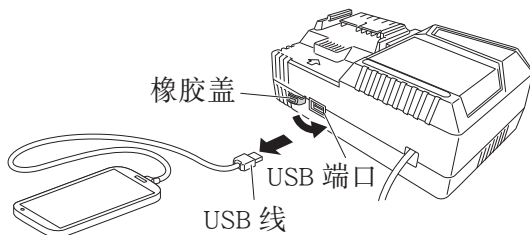
○ 使用有裂纹、变形或者受损的砂轮可能会导致砂轮破裂并造成严重伤害。

1. 检查钹形砂轮

确保钹形砂轮没有裂缝、表面无缺陷。

2. 检查安装的螺丝

定期检查所有安装的螺丝，确保螺丝已完全拧紧。如果螺丝松动，请立即重新拧紧。否则可能导致严重的危险。

注意！

如果使用螺丝松动的电动工具，将非常危险。

中文

3. 检查端子（工具和电池）

确保端子上没有堆积削屑和灰尘。

在操作前、操作时和操作后需要时常检查。

注意！

请清除端子上的削屑或灰尘。

否则可能导致故障。

4. 清洁外部

当充电式角向磨光机脏污时，请用柔软的干布或沾有肥皂水的布片擦拭。请勿使用会融化塑料的含氯溶剂、汽油或油漆稀释剂。

5. 过滤器清洁和检查

警告！

当用吹风枪清洁过滤器时，请戴防护眼镜和防尘口罩。否则，可能会导致吸入碎屑或灰尘，或者使眼睛暴露其中。

使用后，请使用软刷清除粘附在过滤器上的任何切屑或灰尘。（图 19）。定期检查过滤器，确保其没有刮擦、碎裂或撕裂。如果过滤器有任何损坏，请更换新过滤器。

注：

○ 如果网眼堵塞致使切屑或灰尘无法清除，请拆下过滤器并用气枪等清洁。（图 20）

○ 在清洁之后，确保紧固地装好过滤器。



图 19

6. 电动机的维护

电动机绕线是电动工具的“心脏”部。应仔细检查有无损伤，是否被油液或水沾湿。

注：

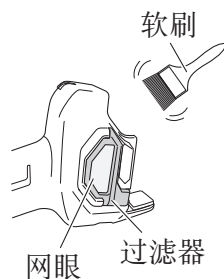
为了排出切屑和灰尘，请定期空载运行电机。



图 20

7. 收藏

充电式角向磨光机应收藏于温度低于 40°C 和小孩拿不到的地方。

注：

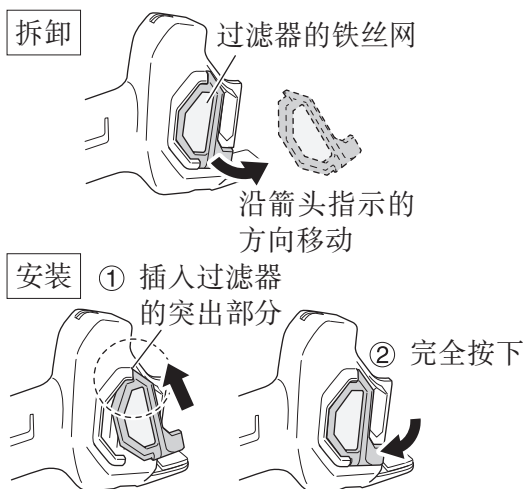
存放锂离子电池

在存放前请确保锂离子电池已完全充电。

电池在低电量的状态下长时间存放（3 个月或更长），可能会导致电池性能劣化，使用时间明显减少或无法进行充电。

但是，即使是使用时间明显减少的电池，通过反复充电和使用 2 – 5 次，有时也可恢复使用时间。

若反复充电和使用后电池的使用时间仍非常短，请认作为电池已达到了使用寿命并更换新的电池。

注意！

在操作和维修电动工具时，必须遵守贵国制定的安全的有关规则和标准。

关于HiKOKI牌无线电动工具的重要通知：

请确保始终使用我们指定的正版电池。如果使用我们指定以外的电池，或对电池进行拆卸和改动（例如拆卸和更换电池组件或其他内部部件），那么我们无法保证我们无线电动工具的安全性和使用性能。

选择附件

根据特定作业选择适合的附件。
有关详细信息请联系HiKOKI授权服务中心。

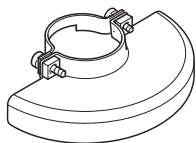

产品编号：331076 (100mm)
331766 (125mm)
砂轮保护装置

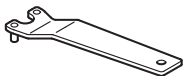

(100mm)
产品编号：313933
扳手

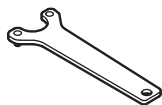

(125mm)
产品编号：938332Z
扳手



产品编号：339578 (100mm)
376067 (125mm)
砂轮垫圈

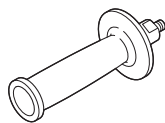
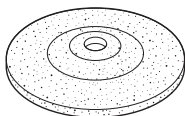

产品编号：378279
侧柄



产品编号：372737 (100mm)
339579 (125mm)
砂轮螺帽

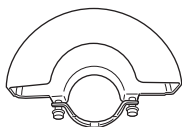

产品编号：302099
(100mm)
砂轮保护装置
(用于切割轮)

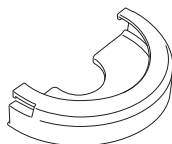

产品编号：372701
(125mm)
防护夹

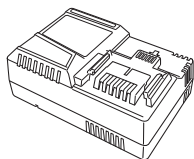

UC18YSL3
(14.4V-18V)
充电器

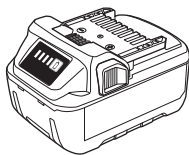

BSL1850MA
电池

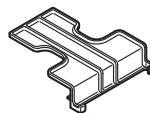

产品编号: 329897
电池盖

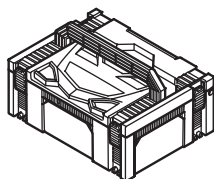

产品编号: 336471
可堆叠外壳

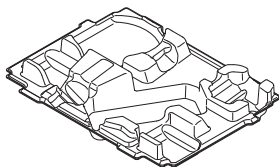

产品编号: 375802
内托盘



产品编号: 372107
过滤器



产品编号: 372108
过滤器

CONTENTS

GENERAL POWER TOOL SAFETY WARNINGS	30
SAFETY WARNINGS COMMON FOR GRINDING OR ABRASIVE CUTTING-OFF OPERATIONS	33
KICKBACK AND RELATED WARNINGS	35
SAFETY WARNINGS SPECIFIC FOR GRINDING AND ABRASIVE CUTTING-OFF OPERATIONS	35
ADDITIONAL SAFETY WARNINGS SPECIFIC FOR ABRASIVE CUTTING-OFF OPERATIONS	36
GENERAL SAFETY INSTRUCTIONS FOR CORDLESS DISC GRINDERS	37
ADDITIONAL SAFETY WARNINGS	38
PRECAUTIONS FOR BATTERY AND CHARGER	39
CAUTION ON LITHIUM-ION BATTERY	39
REGARDING LITHIUM-ION BATTERY TRANSPORTATION	41
USB DEVICE CONNECTION PRECAUTIONS (UC18YSL3)	41
SYMBOLS	42
NAME OF PARTS	42
STANDARD ACCESSORIES	43
APPLICATIONS	43
SPECIFICATIONS	44
BATTERY REMOVAL/INSTALLATION	45
CHARGING	45
PRIOR TO OPERATION	48
GRINDER OPERATION	50
ASSEMBLING AND DISASSEMBLING THE DEPRESSED CENTER WHEEL	52
ASSEMBLING AND DISASSEMBLING THE CUTTING WHEEL AND DIAMOND WHEEL	53
HOW TO RECHARGE USB DEVICE	54
MAINTENANCE AND INSPECTION	55
SELECTING ACCESSORIES	58

GENERAL POWER TOOL SAFETY WARNINGS

WARNING

Read all safety warnings and all instructions.

Failure to follow the warnings and instructions may result in electric shock, fire and/or serious injury.

Save all warnings and instructions for future reference.

The term “power tool” in the warnings refers to your mains-operated (corded) power tool or battery-operated (cordless) power tool.

- 1) **Work area safety**
 - a) **Keep work area clean and well lit.**
Cluttered or dark areas invite accidents.
 - b) **Do not operate power tools in explosive atmospheres, such as in the presence of flammable liquids, gases or dust.**
Power tools create sparks which may ignite the dust or fumes.
 - c) **Keep children and bystanders away while operating a power tool.**
Distractions can cause you to lose control.

- 2) **Electrical safety**
 - a) **Power tool plugs must match the outlet.**
Never modify the plug in any way.
Do not use any adapter plugs with earthed (grounded) power tools.
Unmodified plugs and matching outlets will reduce risk of electric shock.
 - b) **Avoid body contact with earthed or grounded surfaces, such as pipes, radiators, ranges and refrigerators.**
There is an increased risk of electric shock if your body is earthed or grounded.
 - c) **Do not expose power tools to rain or wet conditions.**
Water entering a power tool will increase the risk of electric shock.
 - d) **Do not abuse the cord. Never use the cord for carrying, pulling or unplugging the power tool.**
Keep cord away from heat, oil, sharp edges or moving parts.
Damaged or entangled cords increase the risk of electric shock.
 - e) **When operating a power tool outdoors, use an extension cord suitable for outdoor use.**
Use of a cord suitable for outdoor use reduces the risk of electric shock.
 - f) **If operating a power tool in a damp location is unavoidable, use a residual current device (RCD) protected supply.**
Use of an RCD reduces the risk of electric shock.

- 3) **Personal safety**
 - a) **Stay alert, watch what you are doing and use common sense when operating a power tool.**
Do not use a power tool while you are tired or under the influence of drugs, alcohol or medication.
A moment of inattention while operating power tools may result in serious personal injury.
 - b) **Use personal protective equipment. Always wear eye protection.**
Protective equipment such as dust mask, non-skid safety shoes, hard hat, or hearing protection used for appropriate conditions will reduce personal injuries.
 - c) **Prevent unintentional starting. Ensure the switch is in the off position before connecting to power source and/or battery pack, picking up or carrying the tool.**
Carrying power tools with your finger on the switch or energising power tools that have the switch on invites accidents.

English

- d) **Remove any adjusting key or wrench before turning the power tool on.**
A wrench or a key left attached to a rotating part of the power tool may result in personal injury.
- e) **Do not overreach. Keep proper footing and balance at all times.**
This enables better control of the power tool in unexpected situations.
- f) **Dress properly. Do not wear loose clothing or jewellery. Keep your hair, clothing and gloves away from moving parts.**
Loose clothes, jewellery or long hair can be caught in moving parts.
- g) **If devices are provided for the connection of dust extraction and collection facilities, ensure these are connected and properly used.**
Use of dust collection can reduce dust-related hazards.

4) Power tool use and care

- a) **Do not force the power tool. Use the correct power tool for your application.**
The correct power tool will do the job better and safer at the rate for which it was designed.
- b) **Do not use the power tool if the switch does not turn it on and off.**
Any power tool that cannot be controlled with the switch is dangerous and must be repaired.
- c) **Disconnect the plug from the power source and/or the battery pack from the power tool before making any adjustments, changing accessories, or storing power tools.**
Such preventive safety measures reduce the risk of starting the power tool accidentally.
- d) **Store idle power tools out of the reach of children and do not allow persons unfamiliar with the power tool or these instructions to operate the power tool.**
Power tools are dangerous in the hands of untrained users.
- e) **Maintain power tools. Check for misalignment or binding of moving parts, breakage of parts and any other condition that may affect the power tool's operation.**
If damaged, have the power tool repaired before use.
Many accidents are caused by poorly maintained power tools.
- f) **Keep cutting tools sharp and clean.**
Properly maintained cutting tools with sharp cutting edges are less likely to bind and are easier to control.
- g) **Use the power tool, accessories and tool bits etc. in accordance with these instructions, taking into account the working conditions and the work to be performed.**
Use of the power tool for operations different from those intended could result in a hazardous situation.

5) Battery tool use and care

- a) **Recharge only with the charger specified by the manufacturer.**
A charger that is suitable for one type of battery pack may create a risk of fire when used with another battery pack.

- b) **Use power tools only with specifically designated battery packs.**
Use of any other battery packs may create a risk of injury and fire.
- c) **When battery pack is not in use, keep it away from other metal objects, like paper clips, coins, keys, nails, screws or other small metal objects, that can make a connection from one terminal to another.**
Shorting the battery terminals together may cause burns or a fire.
- d) **Under abusive conditions, liquid may be ejected from the battery; avoid contact. If contact accidentally occurs, flush with water. If liquid contacts eyes, additionally seek medical help.**
Liquid ejected from the battery may cause irritation or burns.

6) Service

- a) **Have your power tool serviced by a qualified repair person using only identical replacement parts.**
This will ensure that the safety of the power tool is maintained.

CAUTION

Keep children and infirm persons away.

When not in use, tools should be stored out of reach of children and infirm persons.

SAFETY WARNINGS COMMON FOR GRINDING OR ABRASIVE CUTTING-OFF OPERATIONS

- a) **This power tool is intended to function as a grinder or cut-off tool. Read all safety warnings, instructions, illustrations and specifications provided with this power tool.**
Failure to follow all instructions listed below may result in electric shock, fire and/or serious injury.
- b) **Operations such as sanding, wire brushing or polishing are not recommended to be performed with this power tool.**
Operations for which the power tool was not designed may create a hazard and cause personal injury.
- c) **Do not use accessories which are not specifically designed and recommended by the tool manufacturer.**
Just because the accessory can be attached to your power tool, it does not assure safe operation.
- d) **The rated speed of the accessory must be at least equal to the maximum speed marked on the power tool.**
Accessories running faster than their rated speed can break and fly apart.
- e) **The outside diameter and the thickness of your accessory must be within the capacity rating of your power tool.**
Incorrectly sized accessories cannot be adequately guarded or controlled.
- f) **Threaded mounting of accessories must match the grinder spindle thread. For accessories mounted by flanges, the arbour hole of the accessory must fit the locating diameter of the flange.**
Accessories that do not match the mounting hardware of the power tool will run out of balance, vibrate excessively and may cause loss of control.

English

- g) **Do not use a damaged accessory. Before each use inspect the accessory such as abrasive wheels for chips and cracks, backing pad for cracks, tear or excess wear, wire brush for loose or cracked wires. If power tool or accessory is dropped, inspect for damage or install an undamaged accessory. After inspecting and installing an accessory, position yourself and bystanders away from the plane of the rotating accessory and run the power tool at maximum no-load speed for one minute.**

Damaged accessories will normally break apart during this test time.

- h) **Wear personal protective equipment. Depending on application, use face shield, safety goggles or safety glasses. As appropriate, wear dust mask, hearing protectors, gloves and workshop apron capable of stopping small abrasive or workpiece fragments.**

The eye protection must be capable of stopping flying debris generated by various operations. The dust mask or respirator must be capable of filtrating particles generated by your operation. Prolonged exposure to high intensity noise may cause hearing loss.

- i) **Keep bystanders a safe distance away from work area. Anyone entering the work area must wear personal protective equipment.**

Fragments of workpiece or of a broken accessory may fly away and cause injury beyond immediate area of operation.

- j) **Hold the power tool by insulated gripping surfaces only, when performing an operation where the cutting tool may contact hidden wiring.**

Contact with a "live" wire will also make exposed metal parts of the power tool "live" and could give the operator an electric shock.

- k) **Position the cord clear of the spinning accessory.**

If you lose control, the cord may be cut or snagged and your hand or arm may be pulled into the spinning accessory.

- l) **Never lay the power tool down until the accessory has come to a complete stop.**

The spinning accessory may grab the surface and pull the power tool out of your control.

- m) **Do not run the power tool while carrying it at your side.**

Accidental contact with the spinning accessory could snag your clothing, pulling the accessory into your body.

- n) **Regularly clean the power tool's air vents.**

The motor's fan will draw the dust inside the housing and excessive accumulation of powdered metal may cause electrical hazards.

- o) **Do not operate the power tool near flammable materials.**

Sparks could ignite these materials.

- p) **Do not use accessories that require liquid coolants.**

Using water or other liquid coolants may result in electrocution or shock.

KICKBACK AND RELATED WARNINGS

Kickback is a sudden reaction to a pinched or snagged rotating wheel, backing pad, brush or any other accessory. Pinching or snagging causes rapid stalling of the rotating accessory which in turn causes the uncontrolled power tool to be forced in the direction opposite of the accessory's rotation at the point of the binding.

For example, if an abrasive wheel is snagged or pinched by the workpiece, the edge of the wheel that is entering into the pinch point can dig into the surface of the material causing the wheel to climb out or kick out. The wheel may either jump toward or away from the operator, depending on direction of the wheel's movement at the point of pinching.

Abrasive wheels may also break under these conditions.

Kickback is the result of power tool misuse and/or incorrect operating procedures or conditions and can be avoided by taking proper precautions as given below.

- a) **Maintain a firm grip on the power tool and position your body and arm to allow you to resist kickback forces. Always use auxiliary handle, if provided, for maximum control over kickback or torque reaction during start-up.**
The operator can control torque reactions or kickback forces, if proper precautions are taken.
- b) **Never place your hand near the rotating accessory.**
Accessory may kickback over your hand.
- c) **Do not position your body in the area where power tool will move if kickback occurs.**
Kickback will propel the tool in direction opposite to the wheel's movement at the point of snagging.
- d) **Use special care when working corners, sharp edges etc. Avoid bouncing and snagging the accessory.**
Corners, sharp edges or bouncing have a tendency to snag the rotating accessory and cause loss of control or kickback.
- e) **Do not attach a saw chain woodcarving blade or toothed saw blade.**
Such blades create frequent kickback and loss of control.

SAFETY WARNINGS SPECIFIC FOR GRINDING AND ABRASIVE CUTTING-OFF OPERATIONS

- a) **Use only wheel types that are recommended for your power tool and the specific guard designed for the selected wheel.**
Wheels for which the power tool was not designed cannot be adequately guarded and are unsafe.
- b) **The grinding surface of centre depressed wheels must be mounted below the plane of the guard lip.**
An improperly mounted wheel that projects through the plane of the guard lip cannot be adequately protected.

English

- c) **The guard must be securely attached to the power tool and positioned for maximum safety, so the least amount of wheel is exposed towards the operator.**
The guard helps to protect the operator from broken wheel fragments, accidental contact with wheel and sparks that could ignite clothing.
- d) **Wheels must be used only for recommended applications. For example: do not grind with the side of cut-off wheel.**
Abrasive cut-off wheels are intended for peripheral grinding, side forces applied to these wheels may cause them to shatter.
- e) **Always use undamaged wheel flanges that are of correct size and shape for your selected wheel.**
Proper wheel flanges support the wheel thus reducing the possibility of wheel breakage. Flanges for cut-off wheels may be different from grinding wheel flanges.
- f) **Do not use worn down wheels from larger power tools.**
Wheel intended for larger power tool is not suitable for the higher speed of a smaller tool and may burst.

ADDITIONAL SAFETY WARNINGS SPECIFIC FOR ABRASIVE CUTTING-OFF OPERATIONS

- a) **Do not “jam” the cut-off wheel or apply excessive pressure. Do not attempt to make an excessive depth of cut.**
Overstressing the wheel increases the loading and susceptibility to twisting or binding of the wheel in the cut and the possibility of kickback or wheel breakage.
- b) **Do not position your body in line with and behind the rotating wheel.**
When the wheel, at the point of operation, is moving away from your body, the possible kickback may propel the spinning wheel and the power tool directly at you.
- c) **When wheel is binding or when interrupting a cut for any reason, switch off the power tool and hold the power tool motionless until the wheel comes to a complete stop. Never attempt to remove the cut-off wheel from the cut while the wheel is in motion otherwise kickback may occur.**
Investigate and take corrective action to eliminate the cause of wheel binding.
- d) **Do not restart the cutting operation in the workpiece. Let the wheel reach full speed and carefully re-enter the cut.**
The wheel may bind, walk up or kickback if the power tool is restarted in the workpiece.
- e) **Support panels or any oversized workpiece to minimize the risk of wheel pinching and kickback.**
Large workpieces tend to sag under their own weight. Supports must be placed under the workpiece near the line of cut and near the edge of the workpiece on both sides of the wheel.
- f) **Use extra caution when making a “pocket cut” into existing walls or other blind areas.**
The protruding wheel may cut gas or water pipes, electrical wiring or objects that can cause kickback.

GENERAL SAFETY INSTRUCTIONS FOR CORDLESS DISC GRINDERS

- Check that speed marked on the wheel is equal to or greater than the rated speed of the grinder;
- Ensure that the wheel dimensions are compatible with the grinder;
- Abrasive wheels shall be stored and handled with care in accordance with manufacturer's instructions;
- Inspect the grinding wheel before use, do not use chipped, cracked or otherwise defective products;
- Ensure that mounted wheels and points are fitted in accordance with the manufacturer's instructions;
- Ensure that blotters are used when they are provided with the bonded abrasive product and when they are required;
- Ensure that the abrasive product is correctly mounted and tightened before use and run the tool at no-load for 30 seconds in a safe position, stop immediately if there is considerable vibration or if other defects are detected. If this condition occurs, check the machine to determine the cause;
- If a guard is equipped with the tool never use the tool without such a guard;
- When using an abrasive cutting wheel, be sure to remove the standard accessory wheel guard and attach the wheel guard with side guard (sold separately) (Fig. 14, 15 on page 52, 53);
- Do not use separate reducing bushings or adapters to adapt large hole abrasive wheels;
- For tools intended to be fitted with threaded hole wheel, ensure that the thread in the wheel is long enough to accept the spindle length;
- Check that the work piece is properly supported;
- Do not use cutting off wheel for side grinding;
- Ensure that sparks resulting from use do not create a hazard e.g. do not hit persons, or ignite flammable substances;
- Ensure that ventilation openings are kept clear when working in dusty conditions, if it should become necessary to clear dust, first disconnect the tool from the mains supply (use non metallic objects) and avoid damaging internal parts;
- Always use eye and ear protection. Other personal protective equipment such as dust mask, gloves, helmet and apron should be worn;
- Pay attention to the wheel that continues to rotate after the tool is switched off.
- Do not allow foreign matter to enter the hole for connecting the rechargeable battery.
- Never disassemble the rechargeable battery and charger.
- Never short-circuit the rechargeable battery.
Short-circuiting the battery will cause a great electric current and overheat. It results in burn or damage to the battery.
- Do not dispose of the battery in fire.
If the battery burnt, it may explode.

English

- Do not insert object into the air ventilation slots of the charger.
Inserting metal objects or inflammables into the charger air ventilation slots will result in electrical shock hazard or damaged charger.
- Bring the battery to the shop from which it was purchased as soon as the post-charging battery life becomes too short for practical use. Do not dispose of the exhausted battery.

WARNING

- When using a cutting-off wheel, be sure to attach the cutting-off guard.
- When using a grinding wheel, be sure to attach the grinding wheel guard.

ADDITIONAL SAFETY WARNINGS

1. Ensure that the depressed center wheel to be utilized is the correct type and free of cracks or surface defects. Also ensure that the depressed center wheel is properly mounted and the wheel nut is securely tightened.
2. Confirm that the push button is disengaged by pushing push button two or three times before switching the power tool on.
3. To prolong the life of the machine and ensure a first class finish, it is important that the machine should not be overloaded by applying too much pressure. In most applications, the weight of the machine alone is sufficient for effective grinding. Too much pressure will result in reduced rotational speed, inferior surface finish, and overloading which could reduce the life of the machine.
4. The wheel continues to rotate after the tool is switched off.
After switching off the machine, do not put it down until the depressed center wheel has come to a complete stop. Apart from avoiding serious accidents, this precaution will reduce the amount of dust and swarf sucked into the machine.
5. Be sure to switch OFF and pull out the battery to avoid a serious accident before the depressed center wheel is assembling and disassembling.
6. Be careful of brake kickback.
This cordless disc grinder features an electric brake that functions when the switch is released. As there is some kickback when the brake functions, be sure to hold the main body securely.
7. Do not use the product if the tool or the battery terminals (battery mount) are deformed.
Installing the battery could cause a short circuit that could result in smoke emission or ignition.
8. Keep the tool's terminals (battery mount) free of swarf and dust.
 - Prior to use, make sure that swarf and dust have not collected in the area of the terminals.
 - During use, try to avoid swarf or dust on the tool from falling on the battery.
 - When suspending operation or after use, do not leave the tool in an area where it may be exposed to falling swarf or dust.
Doing so could cause a short circuit that could result in smoke emission or ignition.

PRECAUTIONS FOR BATTERY AND CHARGER

1. Always charge the battery at an ambient temperature of -10–40°C. A temperature of less than -10°C will result in over charging which is dangerous. The battery cannot be charged at a temperature greater than 40°C.
The most suitable temperature for charging is that of 20–25°C.
2. Do not use the charger continuously.
When one charging is completed, leave the charger for about 15 minutes before the next charging of battery.
3. Do not allow foreign matter to enter the hole for connecting the rechargeable battery.
4. Never disassemble the rechargeable battery or charger.
5. Never short-circuit the rechargeable battery.
Short-circuiting the battery will cause a great electric current and overheat. It results in burn or damage to the battery.
6. Do not dispose of the battery in fire.
If the battery is burnt, it may explode.
7. Using an exhausted battery will damage the charger.
8. Bring the battery to the shop from which it was purchased as soon as the post-charging battery life becomes too short for practical use. Do not dispose of the exhausted battery.
9. Do not insert objects into the air ventilation slots of the charger.
Inserting metal objects or flammable into the charger air ventilation slots will result in an electrical shock hazard or damage to the charger.

CAUTION ON LITHIUM-ION BATTERY

To extend the lifetime, the lithium-ion battery equips with the protection function to stop the output.

In the cases of 1 to 3 described below, when using this product, even if you are pulling the switch, the motor may stop. This is not the trouble but the result of protection function.

1. When the battery power remaining runs out, the motor stops.
In such case, charge it up immediately.
2. If the tool is overloaded, the motor may stop. In this case, release the switch of tool and eliminate causes of overloading. After that, you can use it again.
3. If the battery is overheated under overload work, the battery power may stop.
In this case, stop using the battery and let the battery cool. After that, you can use it again.

Furthermore, please heed the following warning and caution.

WARNING

In order to prevent any battery leakage, heat generation, smoke emission, explosion and ignition beforehand, please be sure to heed the following precautions.

English

1. **Make sure that swarf and dust do not collect on the battery.**
 - **During work make sure that swarf and dust do not fall on the battery.**
 - **Make sure that any swarf and dust falling on the power tool during work do not collect on the battery.**
 - **Do not store an unused battery in a location exposed to swarf and dust.**
 - **Before storing a battery, remove any swarf and dust that may adhere to it and do not store it together with metal parts (screws, nails, etc.).**
2. **Do not pierce battery with a sharp object such as a nail, strike with a hammer, step on, throw or subject the battery to severe physical shock.**
3. **Do not use an apparently damaged or deformed battery.**
4. **Do not use the battery for a purpose other than those specified.**
5. **If the battery charging fails to complete even when a specified recharging time has elapsed, immediately stop further recharging.**
6. **Do not put or subject the battery to high temperatures or high pressure such as into a microwave oven, dryer, or high pressure container.**
7. **Keep away from fire immediately when leakage or foul odor are detected.**
8. **Do not use in a location where strong static electricity generates.**
9. **If there is battery leakage, foul odor, heat generated, discolored or deformed, or in any way appears abnormal during use, recharging or storage, immediately remove it from the equipment or battery charger, and stop use.**
10. **Do not immerse the battery or allow any fluids to flow inside. Conductive liquid ingress, such as water, can cause damage resulting in fire or explosion. Store your battery in a cool, dry place, away from combustible and flammable items. Corrosive gas atmospheres must be avoided.**

CAUTION

1. **If liquid leaking from the battery gets into your eyes, do not rub your eyes and wash them well with fresh clean water such as tap water and contact a doctor immediately.**

If left untreated, the liquid may cause eye-problems.
2. **If liquid leaks onto your skin or clothes, wash well with clean water such as tap water immediately.**

There is a possibility that this can cause skin irritation.
3. **If you find rust, foul odor, overheating, discolor, deformation, and/or other irregularities when using the battery for the first time, do not use and return it to your supplier or vendor.**

WARNING

If an electrically conductive foreign object enters the terminals of the lithium ion battery, a short-circuit may occur resulting in the risk of fire. Please observe the following matters when storing the battery.

- Do not place electrically conductive cuttings, nails, steel wire, copper wire or other wire in the storage case.
- Either install the battery in the power tool or store by securely pressing into the battery cover until the ventilation holes are concealed to prevent short-circuits (See Fig. 1).

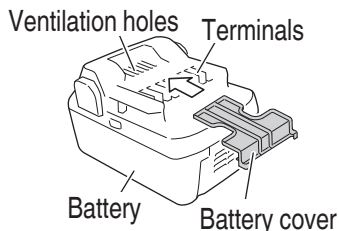

Fig. 1

REGARDING LITHIUM-ION BATTERY TRANSPORTATION

When transporting a lithium-ion battery, please observe the following precautions.

WARNING

Notify the transporting company that a package contains a lithium-ion battery, inform the company of its power output and follow the instructions of the transportation company when arranging transport.

- Lithium-ion batteries that exceed a power output of 100 Wh are considered to be in the freight classification of Dangerous Goods and will require special application procedures. (Fig. 2)
- For transportation abroad, you must comply with international law and the rules and regulations of the destination country.

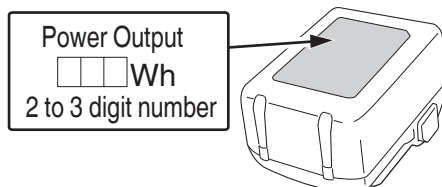

Fig. 2

USB DEVICE CONNECTION PRECAUTIONS (UC18YSL3)

When an unexpected problem occurs, the data in a USB device connected to this product may be corrupted or lost. Always make sure to back up any data contained in the USB device prior to use with this product.

Please be aware that our company accepts absolutely no responsibility for any data stored in a USB device that is corrupted or lost, nor for any damage that may occur to a connected device.

WARNING

- Prior to use, check the connecting USB cable for any defect or damage. Using a defective or damaged USB cable can cause smoke emission or ignition.
- When the product is not being used, cover the USB port with the rubber cover. Buildup of dust etc. in the USB port can cause smoke emission or ignition.

English

NOTE

- There may be an occasional pause during USB recharging.
- When a USB device is not being charged, remove the USB device from the charger. Failure to do so may not only reduce the battery life of a USB device, but may also result in unexpected accidents.
- It may not be possible to charge some USB devices, depending on the type of device.

SYMBOLS

WARNING

The following show symbols used for the machine. Be sure that you understand their meaning before use.

	To reduce the risk of injury, user must read instruction manual.
--	--

NAME OF PARTS

1. POWER TOOL

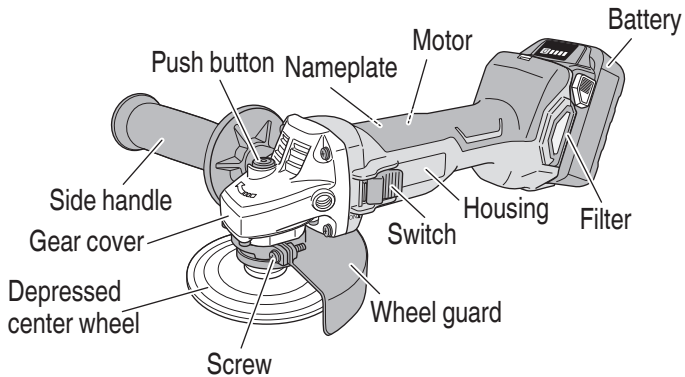
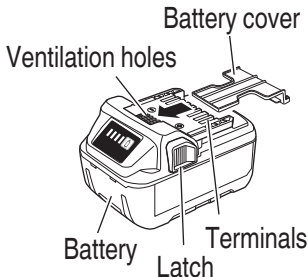

Fig. 3

2. Battery (Optional accessories)



<BSL1850MA>

Fig. 4

3. Battery Charger (Optional accessories)

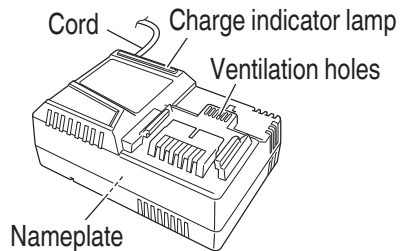





<UC18YSL3>

Fig. 5

STANDARD ACCESSORIES

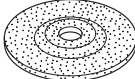
In addition to the main unit (1 unit), the package contains the accessories listed in the below.

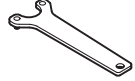
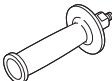
Table 1

	G1810DA	G1813DA
	(NNP)	(NNP)
 Depressed center wheel	1	1
 Wrench (100 mm)	1	—
 Wrench (125 mm)	—	1
 Side handle	1	1
 Stackable case	1	1

APPLICATIONS

- Removal of casting fin and finishing of various types of steel, bronze and aluminum materials and castings.
- Grinding of welded sections or sections cut by means of a cutting torch.
- Grinding of synthetic resins, slate, brick, marble, etc.
- Cutting of synthetic concrete, stone, brick, marble, and similar materials.

SPECIFICATIONS

POWER TOOL

Model		G1810DA	G1813DA
Voltage		18 V	
Rated Speed	Transmission mode	8000 r/min	
Wheel	Outer dia. thickness hole dia.	100 mm 6 mm 16 mm	125 mm 6 mm 22.23 mm
	peripheral speed	72 m/s	80 m/s
Battery		BSL1850MA: Li-ion 18 V (5.0 Ah 10 cells)	
Weight		2.4 kg (BSL1850MA) 2.8 kg (BSL36B18)	2.6 kg (BSL1850MA) 2.9 kg (BSL36B18)

NOTE

Due to HiKOKI's continuing program of research and development, the specifications herein are subject to change without prior notice.

Electronic control

- Soft start
Reduces recoil against the operator by managing the number of rotations during startup.
- Kickback Protection
The kickback protection feature cuts off the power to the motor and stops the power tool in the event of a sudden drop in the rotational speed of the wheel during operation (for example, if the wheel locks during cutting operation, etc.).
- Overload protection
This protection feature cuts off the power to the motor in the event of overloading of motor or a conspicuous reduction in rotational speed during operation.
When the overload protection feature has been activated, the motor may stop.
In this case, release the tool switch and eliminate causes of overloading.
After that you can use it again.
- Overheat protection
This protection feature cuts off the power to the motor and stops the power tool in the event of overheating of motor during operation.
When the overheat protection feature has been activated, the motor may stop.
In this case, release the tool switch and cool it down in a few minutes.
After that you can use it again.
- Restart prevention function
When the power is still switched on, the tool will not restart when a battery is installed. This function can be canceled once the tool is switched off.

CHARGER

Model	UC18YSL3
Charging voltage	14.4 V–18 V
Weight	0.6 kg

BATTERY REMOVAL/INSTALLATION

- Battery removal**
Hold the handle tightly and push the battery latches to remove the battery (see **Fig. 6**).

CAUTION

Never short-circuit the battery.

- Battery installation**
Insert the battery while observing its polarities (see **Fig. 6**).

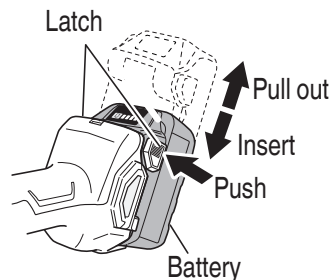

Fig. 6

CHARGING

Before using the power tool, charge the battery as follows.

- Connect the charger's power cord to the receptacle.**
When connecting the plug of the charger to a receptacle, the charge indicator lamp will blink in red (At 1- second intervals).
- Insert the battery into the charger.**
Firmly insert the battery into the charger as shown in **Fig. 7**.

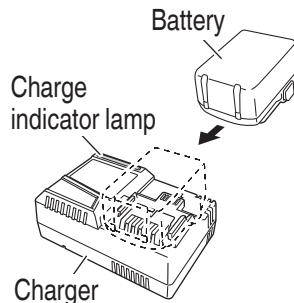









Fig. 7

- Charging**
When inserting a battery in the charger, the charge indicator lamp will blink in blue.
When the battery becomes fully recharged, the charge indicator lamp will light up in green.
(See **Table 2 on page 46**)
- (1) **Charge indicator lamp indication**
The indications of the charge indicator lamp will be as shown in **Table 2 on page 46**, according to the condition of the charger or the rechargeable battery.

Table 2

Indications of the charge indicator lamp				
Charge indicator lamp (RED / BLUE / GREEN / PURPLE)	Before charging	Blinks (RED)	Lights for 0.5 seconds. Does not light for 0.5 seconds. (off for 0.5 seconds) 	Plugged into power source*1
	While charging	Blinks (BLUE)	Lights for 0.5 seconds. Does not light for 1 second. (off for 1 second) 	Battery capacity at less than 50%
		Blinks (BLUE)	Lights for 1 second. Does not light for 0.5 seconds. (off for 0.5 seconds) 	Battery capacity at less than 80%
		Lights (BLUE)	Lights continuously 	Battery capacity at more than 80%
	Charging complete	Lights (GREEN)	Lights continuously  (Continuous buzzer sound: about 6 seconds)	/
	Overheat standby	Blinks (RED)	Lights for 0.3 seconds. Does not light for 0.3 seconds. (off for 0.3 seconds) 	Battery overheated. Unable to charge. (Charging will commence when battery cools)*2
	Charging impossible	Flickers (PURPLE)	Lights for 0.1 seconds. Does not light for 0.1 seconds. (off for 0.1 seconds)  (Intermittent buzzer sound: about 2 seconds)	Malfunction in the battery or the charger*3

*1 If the red lamp continues to blink even after the charger has been attached, check to confirm that the battery has been fully inserted.

*2 Although charging will start once the battery has cooled down even when left in situ, the best practice is to remove the battery and allow it to cool down in a shaded, well-ventilated location before charging.

*3
 Fully insert the battery.
 Check to confirm that no foreign matter is stuck to the battery mount or terminals.

<If charging takes a long time>

Charging will take longer at extremely low ambient temperatures. Charge the battery in a warm location (such as indoors).

- Do not block the air vent. Otherwise the interior will overheat, reducing the charger's performance.
 - If the cooling fan is not operating, contact a HiKOKI Authorized Service Center for repairs.
- (2) Regarding the temperatures and charging time of the rechargeable battery
The temperatures and charging time will become as shown in **Table 3**.

Table 3

Battery		Charger	UC18YSL3	
Type of battery			Li-ion	
Charging voltage			14.4–18 V	
Temperatures at which the battery can be recharged			0°C–50°C	
Charging time, for battery capacity, approx. (At 20°C)		1.5 Ah	15 min	
		2.0 Ah	20 min	
		2.5 Ah	25 min	
		3.0 Ah	20 min (BSL1430C, BSL1830C: 30 min)	
		4.0 Ah	26 min (BSL1840M: 40 min)	
		5.0 Ah	32 min	
		6.0 Ah	38 min	
		8.0 Ah	52 min	
	Multi volt battery		1.5 Ah (×2 unit)	20 min
			2.5 Ah (×2 unit)	32 min
		4.0 Ah (×2 unit)	52 min	
Number of battery cells			4–10	
Charging voltage for USB			5 V	
Charging current for USB			2 A	
Weight			0.6 kg	

NOTE

The recharging time may vary according to the ambient temperature and power source voltage.

4. Disconnect the charger's power cord from the receptacle.

5. Hold the charger firmly and pull out the battery.

NOTE

Be sure to pull out the battery from the charger after use, and then keep it.

English

Regarding electric discharge in case of new batteries, etc.

As the internal chemical substance of new batteries and batteries that have not been used for an extended period is not activated, the electric discharge might be low when using them the first and second time. This is a temporary phenomenon, and normal time required for recharging will be restored by recharging the batteries 2–3 times.

How to make the batteries perform longer.

- (1) Recharge the batteries before they become completely exhausted.
When you feel that the power of the tool becomes weaker, stop using the tool and recharge its battery. If you continue to use the tool and exhaust the electric current, the battery may be damaged and its life will become shorter.
- (2) Avoid recharging at high temperatures.
A rechargeable battery will be hot immediately after use. If such a battery is recharged immediately after use, its internal chemical substance will deteriorate, and the battery life will be shortened. Leave the battery and recharge it after it has cooled for a while.

CAUTION

- **If the battery is charged while it is heated because it has been left for a long time in a location subject to direct sunlight or because the battery has just been used, the charge indicator lamp of the charger lights for 0.3 seconds, does not light for 0.3 seconds (off for 0.3 seconds). In such a case, first let the battery cool, then start charging.**
- **When the charge indicator lamp flickers (at 0.2-second intervals), check for and take out any foreign objects in the charger's battery connector. If there are no foreign objects, it is probable that the battery or charger is malfunctioning. Take it to your authorized Service Center.**

PRIOR TO OPERATION

1. Power switch
Ensure that the switch is in the OFF position.
2. Check your work environment
Ensure the following before operation:
 - No flammable gas, liquid, or object at worksite.
 - When grinding thin steel sheet it may cause a high booming noise.
To avoid such noise, place a rubber mat under the workpiece.
 - Clear the area of children or unauthorized personnel.
3. Fitting and adjusting the wheel guard
The wheel guard is a protective device to prevent injury should the depressed center wheel shatter during operation. Ensure that the guard is properly fitted and fastened before commencing grinding operation.

[How to attach and adjust the wheel guard] (Fig. 8)

- Slightly loosen the screw on the wheel guard.
- Install the wheel guard to the packing gland, turn it to the angle suitable for operation, and make adjustment.
- After the adjustment, ensure that the screw is securely tightened on the wheel guard in order to fix it completely.

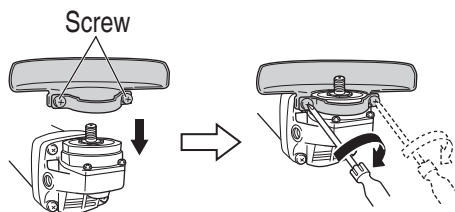

Fig. 8

4. Thoroughly check that the depressed center wheel is free of cracks, splits and other abnormalities before mounting. Make sure it is firmly clamped and has been properly mounted. Refer to page 52 of this manual for ASSEMBLING AND DISASSEMBLING THE DEPRESSED CENTER WHEEL.

5. Test the grinder before using.

Before actually beginning the grinding work, test the grinder by first clearing the area of all other personnel. Make sure the wheel guard is in place and that you are wearing eye protection. Turn the grinder “on”, and make sure the grinder runs smoothly and shows no abnormalities.

Duration of the trial run is as follows:

When depressed center wheel is replaced	3 minutes or more
When starting daily work	1 minute or more

6. Use only properly rated depressed center wheels.

Use only depressed center wheels rated at 13300 r/min or more.

Using a depressed center wheel rated less can lead to wheel disintegration during operation and cause serious bodily injury.

7. Check the push button.

Make sure that the push button is disengaged by pushing push button two or three times before turning on the grinder. (Fig. 9)

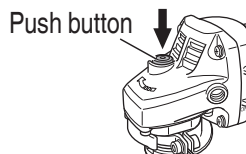

Fig. 9

8. Remaining battery indicator

You can check the battery's remaining capacity by pressing the remaining battery indicator switch to light the indicator lamp.

(Fig. 10, Table 4 on page 50)

The indicator will shut off approximately 3 seconds after the remaining battery indicator switch is pressed.

It is best to use the remaining battery indicator as a guide since there are slight differences such as ambient temperature and the condition of the battery.

Also, the remaining battery indicator may vary from those equipped to a tool or charger.

(A battery is not included with this product.)

Remaining battery indicator lamp Remaining battery indicator switch

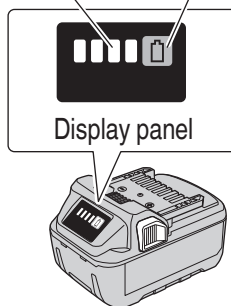





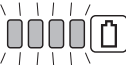
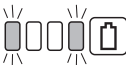

Fig. 10

Table 4

State of lamp	Battery Remaining Power
	Lights ; The battery remaining power is over 75%
	Lights ; The battery remaining power is 50%–75%.
	Lights ; The battery remaining power is 25%–50%.
	Lights ; The battery remaining power is less than 25%
	Blinks ; The battery remaining power is nearly empty. Recharge the battery soonest possible.
	Blinks ; Output suspended due to high temperature. Remove the battery from the tool and allow it to fully cool down.
	Blinks ; Output suspended due to failure or malfunction. The problem may be the battery so please contact your dealer.

As the remaining battery indicator shows somewhat differently depending on ambient temperature and battery characteristics, read it as a reference.

NOTE

Do not give a strong shock to the switch panel or break it. It may lead to a trouble.

GRINDER OPERATION**CAUTION**

To extend the lifetime, the lithium-ion battery equips with the protection function to stop the output. Therefore, if the tool is overloaded, the motor may stop. However, this is not the trouble but the result of protection function. In this case, release the switch of tool and eliminate the causes of overloading.

NOTE

- To prevent injuries, this product has a function that prevents unexpected motor rotation when the battery is inserted. The motor will not run if the battery is inserted while the switch is still ON. After installing the battery, turn the switch off and then back on again.
- These models are equipped with a protection function that will shut down the tool in the event of an overload.
Should the tool shut down due to an overload, turn the power off and then turn it back on again.

An overload that stops tool operation and lasts more than 10 seconds may not be released by turning the power off and on. Should this happen, remove the battery from the tool and reinstall it before turning on the power switch.

1. Hold the grinder firmly by its housing and side handle (**Fig. 11**).

The grinder produces a counterforce which must be controlled by firmly holding onto the grinder.

2. Turn the grinder "on". (**Fig. 12**)

When you start the tool, firstly push the rear part of switch, then push the switch forward. When you need to keep switch in ON position, push the head of switch to latch in ON position.

When release the switch to OFF position, push the rear part of switch.

3. Use light grinding pressure.

There is no need to press hard when grinding. Usually the grinder's own weight is sufficient to allow the required light contact with the surface to be ground.

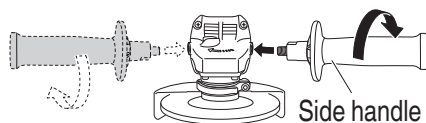

Fig. 11

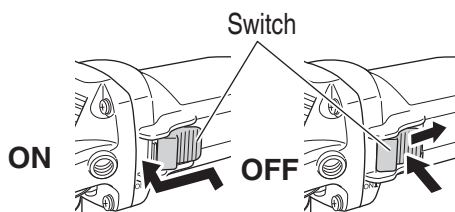

Fig. 12

WARNING

Do not press the grinder forcibly against the surface to be ground. Heavy pressure can result in wheel breakage and serious injury. It can also damage the surface being ground or damage the grinder's motor.

4. Use proper grinding angle. Grind only with the wheel's edge by lifting the grinder 15° to 30° , as shown in **Fig. 13**.

CAUTION

Do not use the entire surface of the depressed center wheel. Use only the edge of the depressed center wheel.

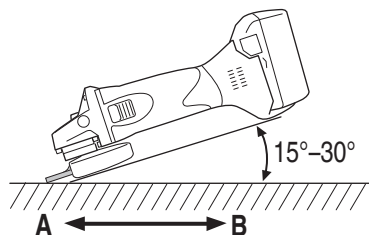

Fig. 13

5. Move the grinder in the proper direction.

When using a new depressed center wheel in direction A (**Fig. 13**), the wheel edge may cut into the workpiece. In this case, grind in direction B (**Fig. 13**). Once the wheel edge is worn, the workpiece can be ground in both directions.

NOTE

The wheel provided (resinoid wheel) is rated as Class A grain and # 36 grain size. It is most suitable for heavy grinding of steel and other types of materials.

English

- Adjust operation to desired finish.
For a fine finish, decrease pressure by lifting slightly. Grind slowly and at the appropriate speed.

CAUTION

The revolving depressed center wheel will create air turbulence.
Do no lay the grinder down in areas of dust or dirt until it has come to a complete stop.

ASSEMBLING AND DISASSEMBLING THE DEPRESSED CENTER WHEEL (Fig. 14)

WARNING

Be sure to turn off the switch and pull out the battery.

- Assembling
 - Turn the disc grinder upsidedown so that the spindle is facing upward.
 - Align the across flats of the wheel washer (A) (G1810DA) or the wheel washer (C) (G1813DA) with the notched part of the spindle, then attach them.
 - Fit the protuberance of the depressed center wheel onto the wheel washer (A) or (C).
 - Screw the wheel nut onto the spindle.
 - While pushing the push button with one hand, lock the spindle by turning the depressed center wheel slowly with the other hand.
Tighten the wheel nut by using the supplied wrench as shown in **Fig. 14**.

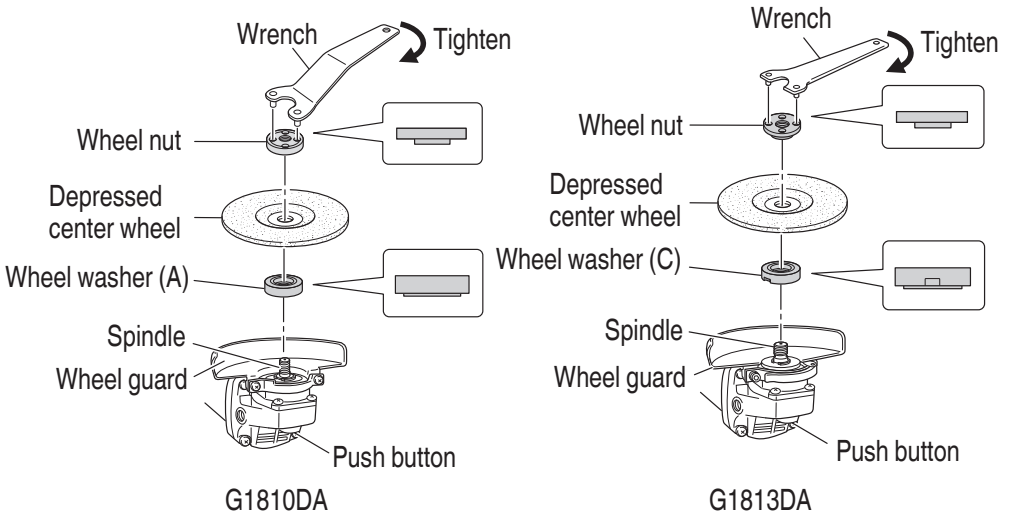

Fig. 14

2. Disassembling
Follow the above procedures in reverse.

CAUTION

- Confirm that the depressed center wheel is mounted firmly.
- Confirm that the push button is disengaged by pushing push button two or three times before switching the power tool on.

ASSEMBLING AND DISASSEMBLING THE CUTTING WHEEL AND DIAMOND WHEEL (Fig. 15)

WARNING

Be sure to turn off the switch and pull out the battery.

1. Assembling
 - (1) Turn the disc grinder upsidedown so that the spindle is facing upward.
 - (2) Align the across flats of the wheel washer (A) (G1810DA) or the wheel washer (C) (G1813DA) with the notched part of the spindle, then attach them.
 - (3) Fit the cutting wheel and diamond wheel onto the wheel washer (A) or (C).
 - (4) Screw the wheel nut onto the spindle.
 - (5) While pushing the push button with one hand, lock the spindle by turning the depressed center wheel slowly with the other hand.
Tighten the wheel nut by using the supplied wrench as shown in **Fig. 15**.

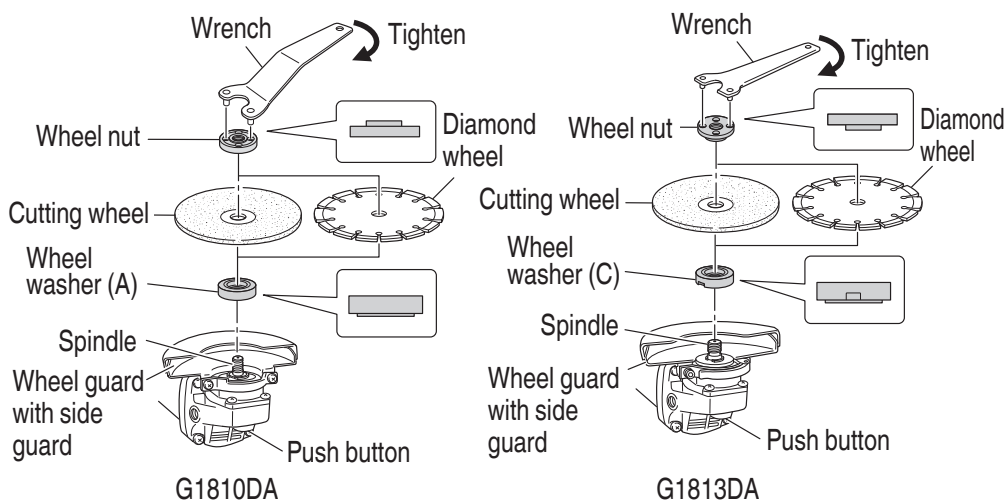

Fig. 15

English

- Disassembling
Follow the above procedures in reverse.

CAUTION

- Confirm that the depressed center wheel is mounted firmly.
- Confirm that the push button is disengaged by pushing push button two or three times before switching the power tool on.

NOTE

- Avoid using excessive force by modifying the feed rate when operating the tool.
- The wheel guard for the cutting wheel will heat up to high temperatures from grind sparks. Do not touch the wheel guard during operation.

HOW TO RECHARGE USB DEVICE

WARNING

- Prior to use, check the connecting USB cable for any defect or damage. Using a defective or damaged USB cable can cause smoke emission or ignition.
- When the product is not being used, cover the USB port with the rubber cover. Buildup of dust etc. in the USB port can cause smoke emission or ignition.

NOTE

- There may be an occasional pause during USB recharging.
 - When a USB device is not being charged, remove the USB device from the charger. Failure to do so may not only reduce the battery life of a USB device, but may also result in unexpected accidents.
 - It may not be possible to charge some USB devices, depending on the type of device.
- Select a charging method
Depending on the charge method selected, either the battery is inserted into the charger or the power cord is plugged into an outlet.
- Charging a USB device from a electrical outlet (Fig. 16-a).
 - Charging a USB device and battery from a electrical outlet.(Fig. 16-b)

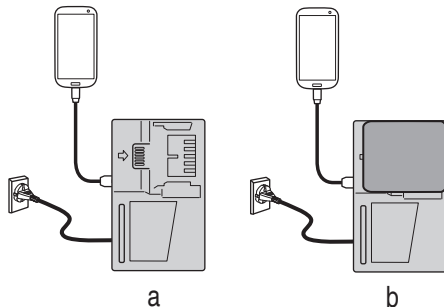

Fig. 16

- (2) Connect the USB cable. (Fig. 17)
 Pull back the rubber cover and firmly plug in a commercially available USB cable (appropriate to the device being charged) into the USB port.

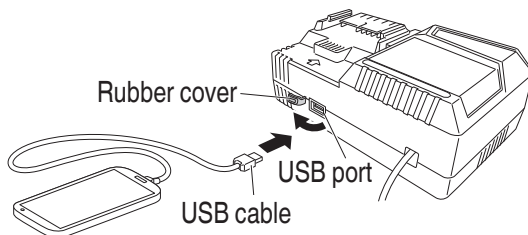

Fig. 17

- (3) When charging is completed
- To verify charge status, check the USB device.
 - Unplug the power cord from the electrical outlet. (Fig. 18)
 - Place the rubber cover over the USB port.

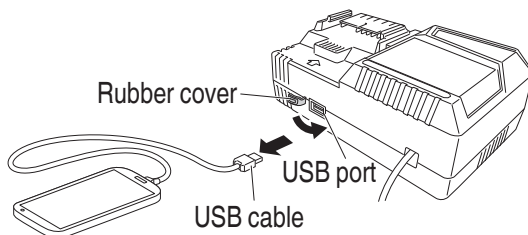

Fig. 18

MAINTENANCE AND INSPECTION

WARNING

- Be sure to turned off the switch and pull out the battery.
- Using cracked, deformed or damaged wheels can lead to wheel breakage and resulting serious injury.

1. Inspecting the depressed center wheel
 Ensure that the depressed center wheel is free of cracks and surface defects.
2. Inspecting the mounting screws
 Regularly inspect all mounting screws and ensure that they are properly tightened. Should any of the screws be loose, retighten them immediately. Failure to do so could result in serious hazard.

CAUTION

Using this power tool with loosened screws is extremely dangerous.

English

3. Inspection of terminals (tool and battery)
Check to make sure that swarf and dust have not collected on the terminals.
On occasion check prior, during and after operation.

CAUTION

**Remove any swarf or dust which may have collected on the terminals.
Failure to do so may result in malfunction.**

4. Cleaning on the outside
When the cordless disc grinder is stained, wipe with a soft dry cloth or a cloth moistened with soapy water. Do not use chloric solvents, gasoline or paint thinner, for they melt plastics.

5. Filter cleaning and inspection

WARNING

Wear protective glasses and a dust mask when cleaning the filter with an air gun. Failure to do so may result in inhalation or exposure of the eyes to debris or dust.

After use, remove any debris or dust adhered to the filter using a soft brush. (Fig. 19)

Check the filter periodically to ensure that it is free of scratching, chipping, or tearing. Replace with a new filter if the filter is damaged in any way.

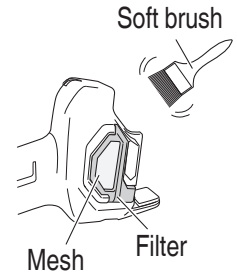
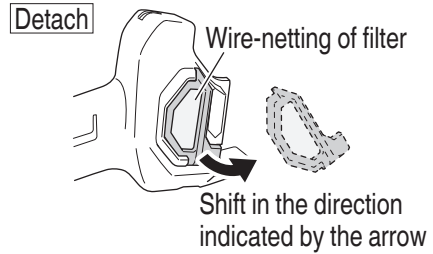

Fig. 19

NOTE

- If the mesh is clogged and the debris or dust cannot be removed, detach the filter and clean it with an air gun, etc. (Fig. 20)
- After cleaning, make sure to securely attach the filter.



6. Maintenance of the motor
The motor unit winding is the very "heart" of the power tool. Exercise due care to ensure the winding does not become damaged and/or wet with oil or water.

NOTE

In order to expel debris and dust, periodically run the motor with no load.

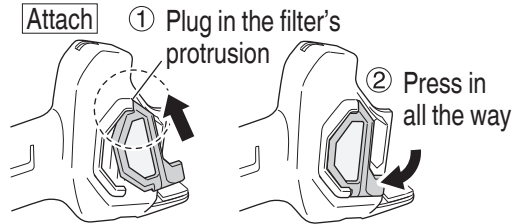

Fig. 20

7. Storage

Store the cordless disc grinder in a place in which the temperature is less than 40°C, and out of reach of children.

NOTE

Storing lithium-ion batteries.

Make sure the lithium-ion batteries have been fully charged before storing them.

Prolonged storage (3 months or more) of batteries with a low charge may result in performance deterioration, significantly reducing battery usage time or rendering the batteries incapable of holding a charge.

However, significantly reduced battery usage time may be recovered by repeatedly charging and using the batteries two to five times.

If the battery usage time is extremely short despite repeated charging and use, consider the batteries dead and purchase new batteries.

CAUTION

In the operation and maintenance of power tools, the safety regulations and standards prescribed in each country must be observed.

Important notice on the batteries for the HiKOKI cordless power tools

Please always use one of our designated genuine batteries. We cannot guarantee the safety and performance of our cordless power tool when used with batteries other than these designated by us, or when the battery is disassembled and modified (such as disassembly and replacement of cells or other internal parts).

SELECTING ACCESSORIES

Select accessories that are suited to a specific task.
For details contact HiKOKI Authorized Service Center.

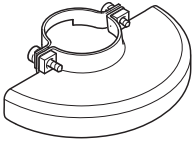

Part Number: 331076 (100 mm)
331766 (125 mm)
Wheel guard



(100 mm)
Part Number: 313933
Wrench

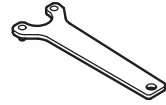

(125 mm)
Part Number: 938332Z
Wrench



Part Number: 339578 (100 mm)
376067 (125 mm)
Wheel washer

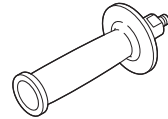
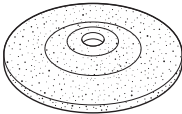

Part Number: 378279
Side handle



Part Number: 372737 (100 mm)
339579 (125 mm)
Wheel nut

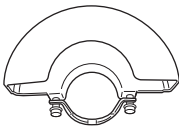

Part Number: 302099
(100 mm)
Wheel guard
(for cutting wheel)

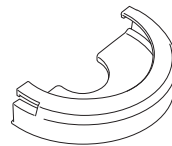

Part Number: 372701
(125 mm)
Guard clip

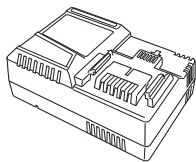

UC18YSL3
(14.4 V-18 V)
Charger

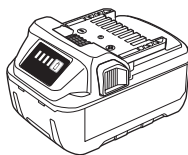

BSL1850MA
Battery

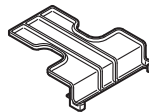

Part Number: 329897
Battery cover

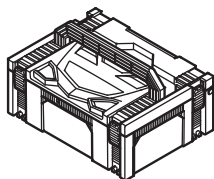

Part Number: 336471
Stackable case

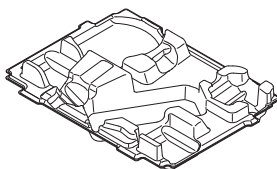

Part Number: 375802
Inner tray



Part Number: 372107
Filter



Part Number: 372108
Filter

服务中心
高壹工机商业(上海)有限公司
上海市闵行区浦江工业园区三鲁路3585号7幢3楼

制造商
广东高壹工机有限公司
广东省广州市番禺区化龙镇工业路富裕围工业村

Koki Holdings Co., Ltd.

205

编号: C99747221 G

发行日期: 2022年 5月

中国印刷