

WH18DC

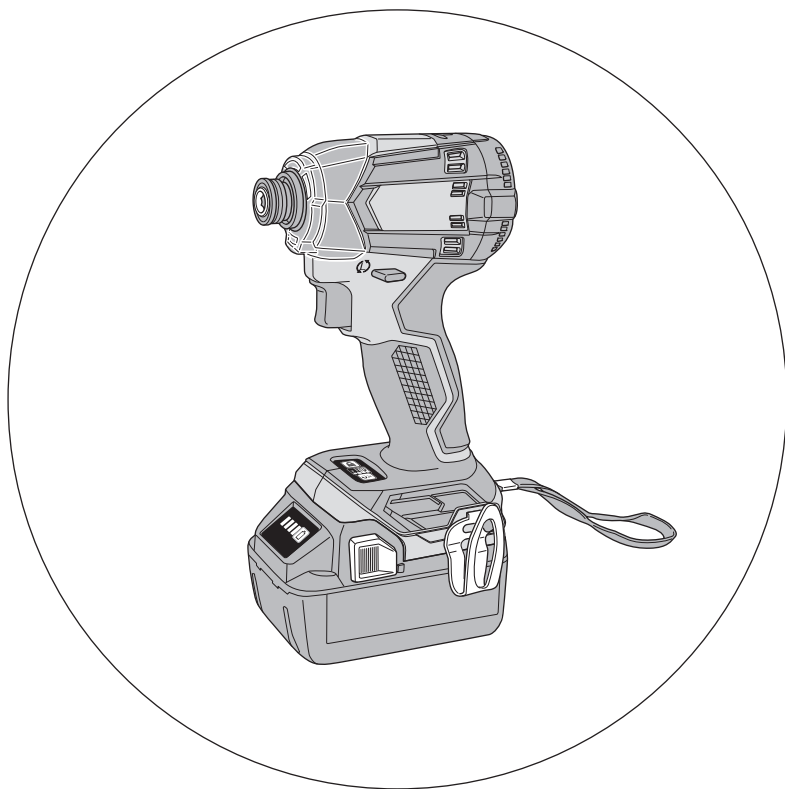

en Handling instructions

zh 使用說明書

1

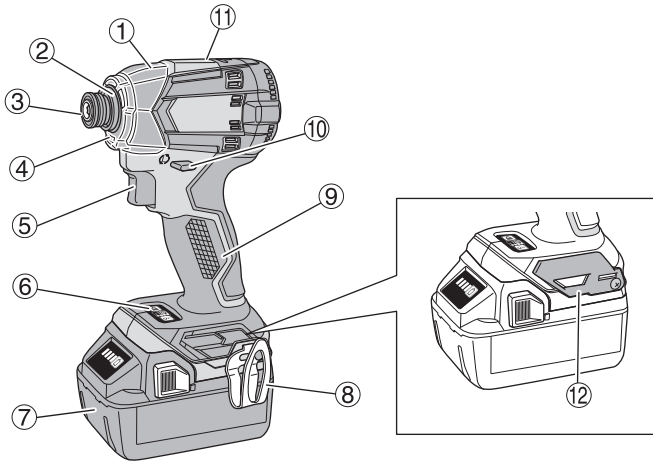

2

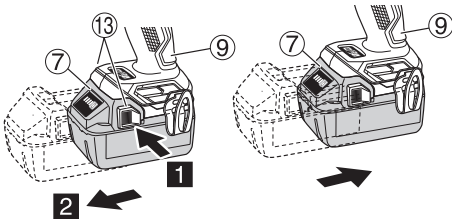

3

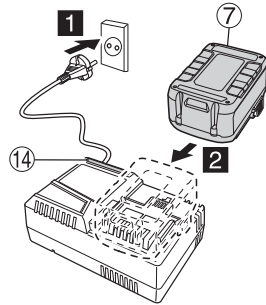

4

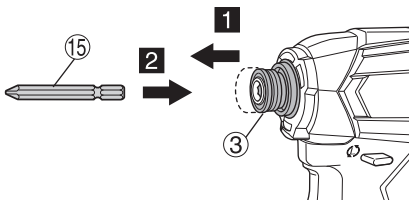

5

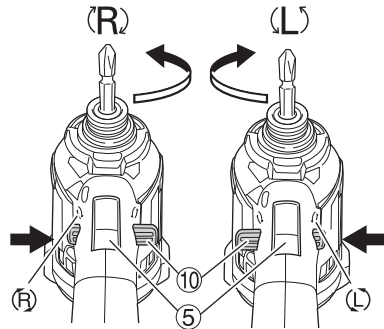

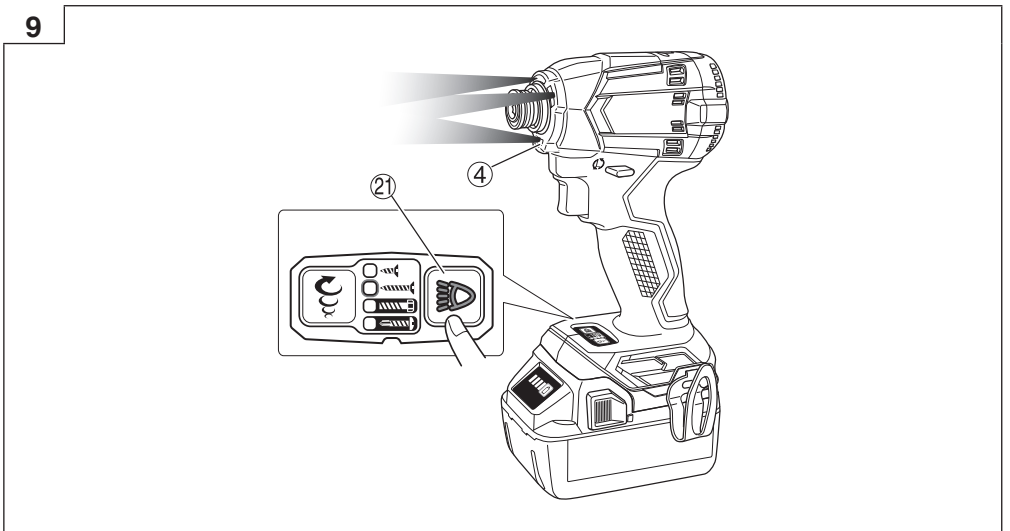
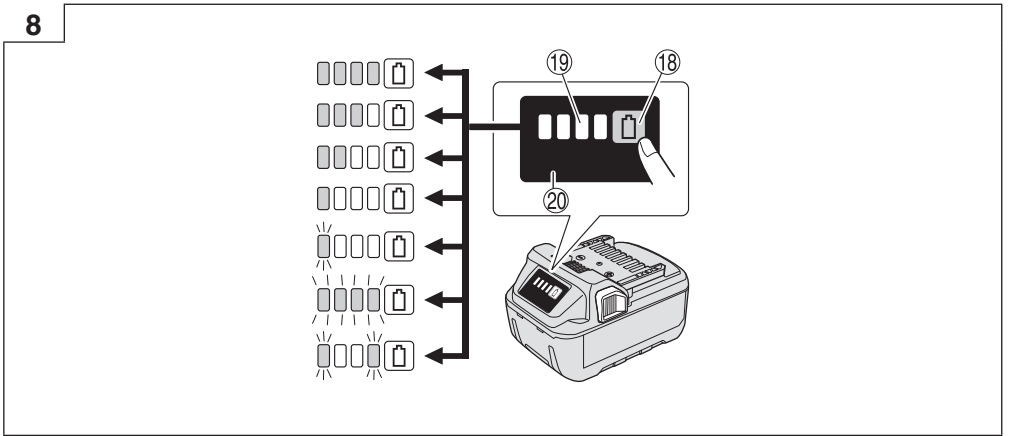
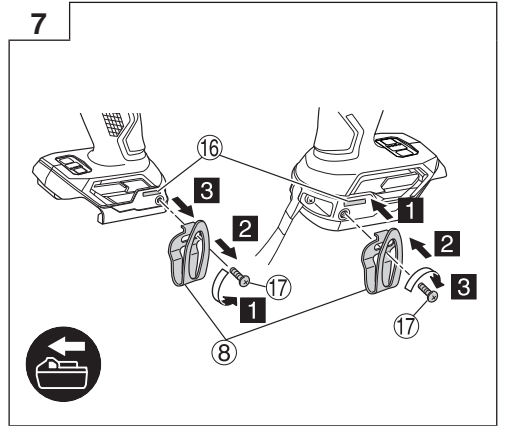
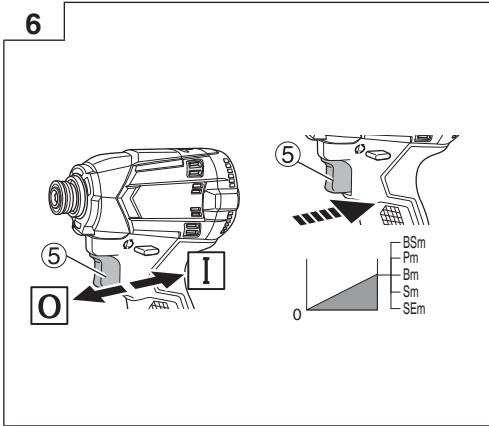

10

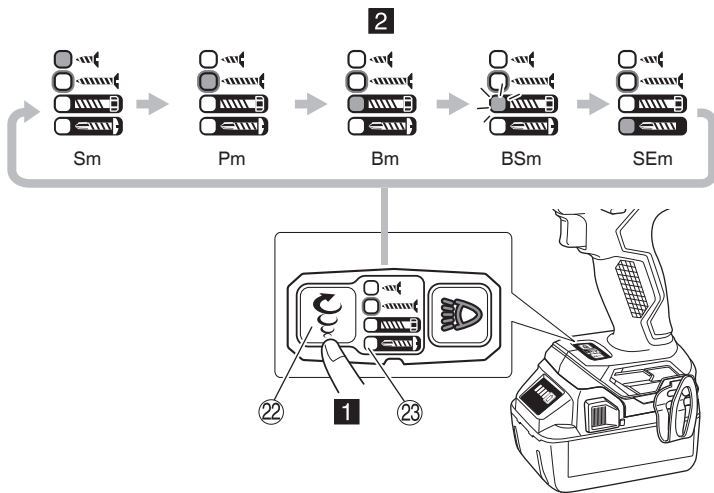

11

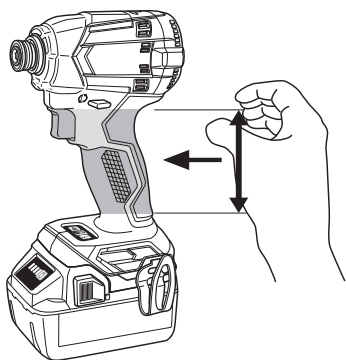

GENERAL POWER TOOL SAFETY WARNINGS

⚠ WARNING

Read all safety warnings, instructions, illustrations and specifications provided with this power tool.

Failure to follow all instructions listed below may result in electric shock, fire and/or serious injury.

Save all warnings and instructions for future reference.

The term "power tool" in the warnings refers to your mains-operated (corded) power tool or battery-operated (cordless) power tool.

1) Work area safety

- a) **Keep work area clean and well lit.**
Cluttered or dark areas invite accidents.
- b) **Do not operate power tools in explosive atmospheres, such as in the presence of flammable liquids, gases or dust.**
Power tools create sparks which may ignite the dust or fumes.
- c) **Keep children and bystanders away while operating a power tool.**
Distractions can cause you to lose control.

2) Electrical safety

- a) **Power tool plugs must match the outlet. Never modify the plug in any way. Do not use any adapter plugs with earthed (grounded) power tools.**
Unmodified plugs and matching outlets will reduce risk of electric shock.
- b) **Avoid body contact with earthed or grounded surfaces, such as pipes, radiators, ranges and refrigerators.**
There is an increased risk of electric shock if your body is earthed or grounded.
- c) **Do not expose power tools to rain or wet conditions.**
Water entering a power tool will increase the risk of electric shock.
- d) **Do not abuse the cord. Never use the cord for carrying, pulling or unplugging the power tool. Keep cord away from heat, oil, sharp edges or moving parts.**
Damaged or entangled cords increase the risk of electric shock.
- e) **When operating a power tool outdoors, use an extension cord suitable for outdoor use.**
Use of a cord suitable for outdoor use reduces the risk of electric shock.
- f) **If operating a power tool in a damp location is unavoidable, use a residual current device (RCD) protected supply.**
Use of an RCD reduces the risk of electric shock.

3) Personal safety

- a) **Stay alert, watch what you are doing and use common sense when operating a power tool. Do not use a power tool while you are tired or under the influence of drugs, alcohol or medication.**
A moment of inattention while operating power tools may result in serious personal injury.
- b) **Use personal protective equipment. Always wear eye protection.**
Protective equipment such as a dust mask, non-skid safety shoes, hard hat or hearing protection used for appropriate conditions will reduce personal injuries.

- c) **Prevent unintentional starting. Ensure the switch is in the off-position before connecting to power source and/or battery pack, picking up or carrying the tool.**

Carrying power tools with your finger on the switch or energising power tools that have the switch on invites accidents.

- d) **Remove any adjusting key or wrench before turning the power tool on.**

A wrench or a key left attached to a rotating part of the power tool may result in personal injury.

- e) **Do not overreach. Keep proper footing and balance at all times.**

This enables better control of the power tool in unexpected situations.

- f) **Dress properly. Do not wear loose clothing or jewellery. Keep your hair and clothing away from moving parts.**

Loose clothes, jewellery or long hair can be caught in moving parts.

- g) **If devices are provided for the connection of dust extraction and collection facilities, ensure these are connected and properly used.**

Use of dust collection can reduce dust-related hazards.

- h) **Do not let familiarity gained from frequent use of tools allow you to become complacent and ignore tool safety principles.**

A careless action can cause severe injury within a fraction of a second.

4) Power tool use and care

- a) **Do not force the power tool. Use the correct power tool for your application.**

The correct power tool will do the job better and safer at the rate for which it was designed.

- b) **Do not use the power tool if the switch does not turn it on and off.**

Any power tool that cannot be controlled with the switch is dangerous and must be repaired.

- c) **Disconnect the plug from the power source and/or remove the battery pack, if detachable, from the power tool before making any adjustments, changing accessories, or storing power tools.**

Such preventive safety measures reduce the risk of starting the power tool accidentally.

- d) **Store idle power tools out of the reach of children and do not allow persons unfamiliar with the power tool or these instructions to operate the power tool.**

Power tools are dangerous in the hands of untrained users.

- e) **Maintain power tools and accessories. Check for misalignment or binding of moving parts, breakage of parts and any other condition that may affect the power tool's operation. If damaged, have the power tool repaired before use.**

Many accidents are caused by poorly maintained power tools.

- f) **Keep cutting tools sharp and clean.**

Properly maintained cutting tools with sharp cutting edges are less likely to bind and are easier to control.

- g) **Use the power tool, accessories and tool bits etc. in accordance with these instructions, taking into account the working conditions and the work to be performed.**

Use of the power tool for operations different from those intended could result in a hazardous situation.

- h) **Keep handles and grasping surfaces dry, clean and free from oil and grease.**

English

Slippery handles and grasping surfaces do not allow for safe handling and control of the tool in unexpected situations.

5) Battery tool use and care

a) Recharge only with the charger specified by the manufacturer.

A charger that is suitable for one type of battery pack may create a risk of fire when used with another battery pack.

b) Use power tools only with specifically designated battery packs.

Use of any other battery packs may create a risk of injury and fire.

c) When battery pack is not in use, keep it away from other metal objects, like paper clips, coins, keys, nails, screws or other small metal objects, that can make a connection from one terminal to another.

Shorting the battery terminals together may cause burns or a fire.

d) Under abusive conditions, liquid may be ejected from the battery; avoid contact. If contact accidentally occurs, flush with water. If liquid contacts eyes, additionally seek medical help.

Liquid ejected from the battery may cause irritation or burns.

e) Do not use a battery pack or tool that is damaged or modified.

Damaged or modified batteries may exhibit unpredictable behaviour resulting in fire, explosion or risk of injury.

f) Do not expose a battery pack or tool to fire or excessive temperature.

Exposure to fire or temperature above 130°C may cause explosion.

g) Follow all charging instructions and do not charge the battery pack or tool outside the temperature range specified in the instructions.

Charging improperly or at temperatures outside the specified range may damage the battery and increase the risk of fire.

6) Service

a) Have your power tool serviced by a qualified repair person using only identical replacement parts.

This will ensure that the safety of the power tool is maintained.

b) Never service damaged battery packs.

Service of battery packs should only be performed by the manufacturer or authorized service providers.

PRECAUTION

Keep children and infirm persons away.

When not in use, tools should be stored out of reach of children and infirm persons.

CORDLESS IMPACT DRIVER SAFETY WARNINGS

Hold the power tool by insulated gripping surfaces, when performing an operation where the fastener may contact hidden wiring. Fasteners contacting a "live" wire may make exposed metal parts of the power tool "live" and could give the operator an electric shock.

ADDITIONAL SAFETY WARNINGS

1. This is a portable tool for tightening and loosening screws, bolts and nuts. Use it only for these operation.
2. Make sure to securely hold the tool during operation. Failure to do so can result in accidents or injuries. (Fig. 11)
3. Make sure that the battery is installed firmly. If it is as all loose it could come off and cause an accident.
4. Preparing and checking the work environment. Make sure that the work site meets all the conditions laid forth in the precautions.
5. Do not allow foreign matter to enter the hole for connecting the rechargeable battery.
6. Never disassemble the rechargeable battery and charger.
7. Never short-circuit the rechargeable battery. Short-circuiting the battery will cause a great electric current and overheat. It results in burn or damage to the battery.
8. Do not dispose of the battery in fire. If the battery is burnt, it may explode.
9. Bring the battery to the shop from which it was purchased as soon as the post-charging battery life becomes too short for practical use. Do not dispose of the exhausted battery.
10. Do not insert object into the air ventilation slots of the charger. Inserting metal objects or inflammables into the charger air ventilation slots will result in electrical shock hazard or damaged charger.
11. Check the actual tightening torque with a torque wrench.
12. Stop the tool before switching the direction of rotation. Always release the switch and wait for tool to stop before switching the direction of rotation.
13. Never touch the turning part. Do not allow the turning part section to get near your hands or any other part of your body. You could be cut or caught in the turning part. Also, be careful not to touch the turning part after using continuously it for a long time. It gets quite hot and could burn you.
14. Please use the designated attachments which are listed in the operations manual and HiKOKI's catalog. Accidents or injuries could result from not doing so.
15. Make sure to firmly install the attachments in the anvil. If the attachments is not firmly installed it might come out and cause injuries.
After installing the driver bit, pull lightly out the bit to make sure that it does not come loose during use. If the guide sleeve does not return to its original position, then the bit is not installed properly.
16. Resting the unit after continuous work.
17. The power tool is equipped with a temperature protection circuit to protect the motor. Continuous work may cause the temperature of the unit to rise, activating the temperature protection circuit and automatically stopping operation. If this happens, allow the power tool to cool before resuming use.
18. The motor may stop in the event the tool is overloaded. In this should occur, release the tool's switch and eliminate the cause of the overload.
Avoid touching the front case which can heat up during continuous operation.
19. The use of the battery in a cold condition (below 0 degree Centigrade) can sometimes result in the weakened tightening torque and reduced amount of work. This, however, is a temporary phenomenon, and returns to normal when the battery warms up.
20. Install securely the hook. Unless the hook is securely installed, it may cause an injury while using.
When electing to carry the tool hooked to your hip belt, make sure to detach the tool bit and side handle. Failure to do so may result in unexpected injury.

21. Do not touch the metal parts, as it gets very hot during continuous work.
22. Do not look directly into the light. Such actions could result in eye injury.
Wipe off any dirt or grime attached to the lens of the LED light with a soft cloth, being careful not to scratch the lens.
Scratches on the lens of the LED light can result in decreased brightness.
23. Do not use the product if the tool or the battery terminals (battery mount) are deformed.
Installing the battery could cause a short circuit that could result in smoke emission or ignition.
24. Keep the tool's terminals (battery mount) free of swarf and dust.
 - Prior to use, make sure that swarf and dust have not collected in the area of the terminals.
 - During use, try to avoid swarf or dust on the tool from falling on the battery.
 - When suspending operation or after use, do not leave the tool in an area where it may be exposed to falling swarf or dust.
Doing so could cause a short circuit that could result in smoke emission or ignition.
25. Always use the tool and battery at temperatures between -5°C and 40°C.
26. Always charge the battery at an ambient temperature of 0–40°C.
7. If the battery charging fails to complete even when a specified recharging time has elapsed, immediately stop further recharging.
8. Do not put or subject the battery to high temperatures or high pressure such as into a microwave oven, dryer, or high pressure container.
9. Keep away from fire immediately when leakage or foul odor are detected.
10. Do not use in a location where strong static electricity generates.
11. If there is battery leakage, foul odor, heat generated, discolored or deformed, or in any way appears abnormal during use, recharging or storage, immediately remove it from the equipment or battery charger, and stop use.
12. Do not immerse the battery or allow any fluids to flow inside. Conductive liquid ingress, such as water, can cause damage resulting in fire or explosion. Store your battery in a cool, dry place, away from combustible and flammable items. Corrosive gas atmospheres must be avoided.

CAUTION

1. If liquid leaking from the battery gets into your eyes, do not rub your eyes and wash them well with fresh clean water such as tap water and contact a doctor immediately.
If left untreated, the liquid may cause eye-problems.
2. If liquid leaks onto your skin or clothes, wash well with clean water such as tap water immediately.
There is a possibility that this can cause skin irritation.
3. If you find rust, foul odor, overheating, discolor, deformation, and/or other irregularities when using the battery for the first time, do not use and return it to your supplier or vendor.

WARNING

If a conductive foreign matter enters in the terminal of lithium ion battery, the battery may be shorted, causing fire. When storing the lithium ion battery, obey surely the rules of following contents.

- Do not place conductive debris, nail and wires such as iron wire and copper wire in the storage case.
- To prevent shorting from occurring, load the battery in the tool or insert securely the battery cover for storing until the ventilator is not seen.

REGARDING LITHIUM-ION BATTERY TRANSPORTATION

When transporting a lithium-ion battery, please observe the following precautions.

WARNING

Notify the transporting company that a package contains a lithium-ion battery, inform the company of its power output and follow the instructions of the transportation company when arranging transport.

- Lithium-ion batteries that exceed a power output of 100 Wh are considered to be in the freight classification of Dangerous Goods and will require special application procedures.
- For transportation abroad, you must comply with international law and the rules and regulations of the destination country.

CAUTION ON LITHIUM-ION BATTERY

To extend the lifetime, the lithium-ion battery equips with the protection function to stop the output.

In the cases of 1 to 3 described below, when using this product, even if you are pulling the switch, the motor may stop. This is not the trouble but the result of protection function.

1. When the battery power remaining runs out, the motor stops.
In such a case, charge it up immediately.
2. If the tool is overloaded, the motor may stop. In this case, release the switch of tool and eliminate causes of overloading. After that, you can use it again.
3. If the battery is overheated under overload work, the battery power may stop.
In this case, stop using the battery and let the battery cool. After that, you can use it again.

Furthermore, please heed the following warning and caution.

WARNING

In order to prevent any battery leakage, heat generation, smoke emission, explosion and ignition beforehand, please be sure to heed the following precautions.

1. Make sure that swarf and dust do not collect on the battery.
 - During work make sure that swarf and dust do not fall on the battery.
 - Make sure that any swarf and dust falling on the power tool during work do not collect on the battery.
 - Do not store an unused battery in a location exposed to swarf and dust.
 - Before storing a battery, remove any swarf and dust that may adhere to it and do not store it together with metal parts (screws, nails, etc.).
2. Do not pierce battery with a sharp object such as a nail, strike with a hammer, step on, throw or subject the battery to severe physical shock.
3. Do not use an apparently damaged or deformed battery.
4. Do not use the battery in reverse polarity.
5. Do not connect directly to an electrical outlets or car cigarette lighter sockets.
6. Do not use the battery for a purpose other than those specified.

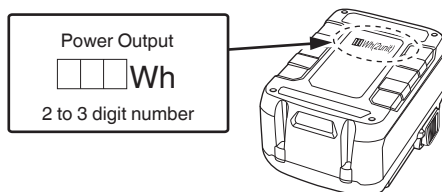



PRECAUTIONS REGARDING THE DUST-RESISTANCE AND WATER-PROOFING FUNCTIONS

This product conforms to IP56 protection class ratings (dust-resistance and water-proofing) for electrical equipment as stipulated by the international IEC regulations. (Only the main unit conforms to the IP56 protection class ratings when equipped with a battery.)

[Descriptions of IP Codes]

IP56

-  Protection rating for water penetration
 Must be no adverse effects on the equipment when sprayed with powerful jets of water from all directions (water-proofed).
 (100 L of water per minute sprayed for approximately three minutes from a distance of approximately three meters with the use of a spray nozzle with a diameter of 12.5 mm.)
-  Protection rating for external assault by solid objects
 Dust that may cause adverse effects on the equipment must not be able to enter (dust-resistance).
 (The equipment to be left non-operable in a test chamber in which particles of talcum powder with a diameter of less than 75 µm are floating in the air with the use of an agitation pump at a rate of 2 kg per cubic meter for eight hours.)

The equipment has been designed to withstand the effects of dust and water, but there is no guarantee that it will not malfunction. Do not use or leave the equipment in locations where it is subject to excessive amounts of dust, or in locations where it is submerged in water or subject to rainwater.



NAMES OF PARTS (Fig. 1–Fig. 11)













①	Protector	⑬	Latch
②	Hammer case	⑭	Charge indicator lamp
③	Guide sleeve	⑮	Driver bit (sold separately)
④	LED Light	⑯	Groove
⑤	Trigger switch	⑰	Screw
⑥	Switch panel	⑱	Remaining battery indicator switch
⑦	Battery	⑲	Remaining battery indicator lamp
⑧	Hook	⑳	Display panel
⑨	Handle	㉑	Light section switch
⑩	Push button	㉒	Tightening mode selector switch
⑪	Housing	㉓	Tightening mode indicator lamp
⑫	Color plate (sold separately)		

SYMBOLS

WARNING

The following show symbols used for the machine.
Be sure that you understand their meaning before use.

	WH18DC: Cordless Impact Driver
	To reduce the risk of injury, user must read instruction manual.
	Direct current
V	Rated voltage
n ₀	No-load speed

/min	Oscillation per minute
Pm	Power mode
BSm	Bolt single mode
Bm	Bolt mode
Sm	Soft mode
SEm	Self drilling screw mode
Bpm	Impact rate
	Small screw
	Ordinary bolt
	High tension bolt
	Self drilling screw
MT	Tightening torque (Maximum)
	Hex. drive size
	Weight
	Switching ON
	Switching OFF
	Disconnect the battery
	Light section switch
	Clockwise rotation
	Counterclockwise rotation
	Remaining battery indicator switch

	Lights ; The battery remaining power is over 75%.
	Lights ; The battery remaining power is 50%–75%.
	Lights ; The battery remaining power is 25%–50%.
	Lights ; The battery remaining power is less than 25%.
	Blinks ; The battery remaining power is nearly empty. Recharge the battery soonest possible.
	Blinks ; Output suspended due to high temperature. Remove the battery from the tool and allow it to fully cool down.
	Blinks ; Output suspended due to failure or malfunction. The problem may be the battery so please contact your dealer.
	Tightening mode selector switch
	Tightening mode indicator lamp
	Lighting: "delicate work" Small diameter machine screws (M6 level), etc.
	Lighting: "from normal work to heavy load work" Overall screws, long screws, coach screws
	Lighting: "tightening and loosening nuts and bolts"
	Blinking: "delicate work" Bolts used for racks, fences, furniture, etc.
	Lighting: Self drilling screw
	Warning

SPECIFICATIONS

The specifications of this machine are listed in the Table on page 23.

NOTE

Due to HIKOKI's continuing program of research and development, the specifications herein are subject to change without prior notice.

CHARGING

Before using the power tool, charge the battery as follows.

- 1. Connect the charger's power cord to the receptacle.**
When connecting the plug of the charger to a receptacle, the pilot lamp will blink in red (At 1- second intervals).
 - 2. Insert the battery into the charger.**
Firmly insert the battery into the charger as shown in **Fig. 3** (on page 2).
 - 3. Charging**
When inserting a battery in the charger, the charge indicator lamp will blink in blue.
When the battery becomes fully recharged, the charge indicator lamp will light up in green. (See **Table 1**)
- (1) Charge indicator lamp indication
The indications of the charge indicator lamp will be as shown in **Table 1**, according to the condition of the charger or the rechargeable battery.

STANDARD ACCESSORIES

In addition to the main unit (1 unit), the package contains the accessories listed on page 23.

Standard accessories are subject to change without notice.

APPLICATIONS

Driving and removing of machine screws, wood screws, tapping screws, etc.

Table 1

Indications of the charge indicator lamp				
Charge indicator lamp (RED / BLUE / GREEN / PURPLE)	Before charging	Blinks (RED)	Lights for 0.5 seconds. Does not light for 0.5 seconds. (off for 0.5 seconds)	Plugged into power source
	While charging	Blinks (BLUE)	Lights for 0.5 seconds. Does not light for 1 second. (off for 1 second)	Battery capacity at less than 50%
		Blinks (BLUE)	Lights for 1 second. Does not light for 0.5 seconds. (off for 0.5 seconds)	Battery capacity at less than 80%
		Lights (BLUE)	Lights continuously	Battery capacity at more than 80%
	Charging complete	Lights (GREEN)	Lights continuously (Continuous buzzer sound: about 6 seconds)	
	Overheat standby	Blinks (RED)	Lights for 0.3 seconds. Does not light for 0.3 seconds. (off for 0.3 seconds)	Battery overheated. Unable to charge. (Charging will commence when battery cools)
	Charging impossible	Flickers (PURPLE)	Lights for 0.1 seconds. Does not light for 0.1 seconds. (Intermittent buzzer sound: about 2 seconds)	Malfunction in the battery or the charger

(2) Regarding the temperatures and charging time of the rechargeable battery
The temperatures and charging time will become as shown in **Table 2**.

Table 2

Charger		UC18YSL3					
Battery	Type of battery	Li-ion					
	Temperatures at which the battery can be recharged	0°C–50°C					
	Charging voltage	V	14.4		18		
	Charging time, approx. (At 20°C)	min	BSL14xx series		BSL18xx series		Multi volt series
			(4 cells)	(8 cells)	(5 cells)	(10 cells)	(10 cells)
		BSL1415S : 15 BSL1415 : 15 BSL1415X : 15 BSL1420 : 20 BSL1425 : 25 BSL1430C : 30	BSL1430 : 20 BSL1440 : 26 BSL1450 : 32 BSL1460 : 38	BSL1815S : 15 BSL1815 : 15 BSL1815X : 15 BSL1820 : 20 BSL1825 : 25 BSL1830C : 30 BSL1840M : 40 BSL1850C : 32	BSL1830 : 20 BSL1840 : 26 BSL1850 : 32 BSL1850MA : 32 BSL1860 : 38	BSL36A18 : 32 BSL36B18 : 52	

NOTE

The recharging time may vary according to the ambient temperature and power source voltage.

4. Disconnect the charger's power cord from the receptacle.

5. Hold the charger firmly and pull out the battery.

NOTE

Be sure to pull out the battery from the charger after use, and then keep it.

Regarding electric discharge in case of new batteries, etc.

As the internal chemical substance of new batteries and batteries that have not been used for an extended period is not activated, the electric discharge might be low when using them the first and second time. This is a temporary phenomenon, and normal time required for recharging will be restored by recharging the batteries 2–3 times.

How to make the batteries perform longer.

(1) Recharge the batteries before they become completely exhausted.

When you feel that the power of the tool becomes weaker, stop using the tool and recharge its battery. If you continue to use the tool and exhaust the electric current, the battery may be damaged and its life will become shorter.

(2) Avoid recharging at high temperatures.

A rechargeable battery will be hot immediately after use. If such a battery is recharged immediately after use, its internal chemical substance will deteriorate, and the battery life will be shortened. Leave the battery and recharge it after it has cooled for a while.

CAUTION

- If the battery is charged while it is heated because it has been left for a long time in a location subject to direct sunlight or because the battery has just been used, the charge indicator lamp of the charger lights for 0.3 seconds, does not light for 0.3 seconds (off for 0.3 seconds). In such a case, first let the battery cool, then start charging.
- When the charge indicator lamp flickers (at 0.2-second intervals), check for and take out any foreign objects in the charger's battery connector. If there are no foreign objects, it is probable that the battery or charger is malfunctioning. Take it to your authorized Service Center.
- Since the built-in micro computer takes about 3 seconds to confirm that the battery being charged with UC18YSL3 is taken out, wait for a minimum of 3 seconds before reinserting it to continue charging. If the battery is reinserted within 3 seconds, the battery may not be properly charged.

By using the Tightening mode selector switch, the tightening torque can be adjusted according to the type of work. The Tightening mode switches between 5 different modes each time the Tightening mode selector switch is pressed. Upon pulling the trigger switch in bolt single mode, the driver will automatically stop after applying a number of impacts. Soft / power / bolt and self drilling screw mode will commence impact upon pulling the trigger switch and will continuously apply impact without auto-stopping. Soft mode is a mode that does not inflict damage on thin nails or decorative materials. Power mode can be used for normal work up to heavy load work. Bolt mode has a short pull margin for the trigger switch, making the driver ideal for high-speed tightening work. Bolt single mode controls the impact, allowing control of the tightening force. Use this mode for delicate work such as tightening bolts for racks, fences, furniture, etc. Self drilling screw mode is ideal for tightening self drilling screws by reducing the chances of overtightening that could result in severing the screw head, breaking the screw, or slippage.

MOUNTING AND OPERATION

Action	Figure	Page
Removing and inserting the battery	2	2
Charging	3	2
Mounting the bit	4	2
Reversing the rotational direction	5	2
Switch operation	6	3
Removing and mounting the hook	7	3
Remaining battery indicator	8	3
How to use the LED light*1	9	3
Tightening mode selector function*2	10	4
Selecting accessories	—	24

NOTE

- The appropriate mode differs depending on the screw and the material being screwed. Drive in a few test screws and adjust the mode setting accordingly.
- The tightening mode selector switch can only be set after the battery has been installed in the driver and the trigger switch has been pulled once.

LED LIGHT WARNING SIGNAL (Fig. 12)

This product features functions that are designed to protect the tool itself as well as the battery. While the switch is pulled, if any of the safeguard functions are triggered during operation, the LED light will blink as described in **Table 3**. When any of the safeguard functions are triggered, immediately remove your finger from the switch and follow the instructions described under corrective action.

*1 How to use the LED light

NOTE

- Press the light section switch on the switch panel to change the lighting mode of the LED light from "Always-ON" → "SW interlocked" → "OFF".
- To conserve battery power, make sure to extinguish the light as much as possible.
- To prevent the battery power consumption caused by forgetting to turn off the LED light, the light goes off automatically in about 2 minutes.

*2 Tightening mode selector function

CAUTION

Select tightening mode while the trigger switch is released. Failure to do so could result in malfunction.

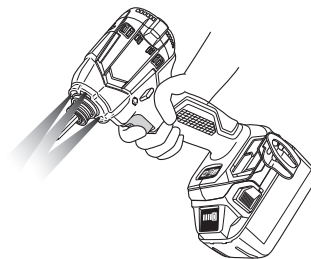

Fig. 12

Table 3

Safeguard Function	LED Light Display	Corrective Action
Temperature Protection	On 0.3 second/off 0.3 second <div style="display: flex; justify-content: space-around; width: 100px;"> <div style="width: 10px; height: 10px; background-color: black;"></div> <div style="width: 10px; height: 10px; background-color: black;"></div> <div style="width: 10px; height: 10px; background-color: black;"></div> <div style="width: 10px; height: 10px; background-color: black;"></div> </div>	Allow the tool and battery to thoroughly cool.

MAINTENANCE AND INSPECTION

1. Inspecting the driver bit

Using a broken bit or one with a worn out tip is dangerous because the bit can slip. Replace it.

2. Inspecting the mounting screws

Regularly inspect all mounting screws and ensure that they are properly tightened. Should any of the screws be loose, retighten them immediately. Failure to do so could result in serious hazard.

3. Maintenance of the motor

The motor unit winding is the very "heart" of the power tool. Exercise due care to ensure the winding does not become damaged and/or wet with oil or water.

4. Inspection of terminals (tool and battery)

Check to make sure that swarf and dust have not collected on the terminals.

On occasion check prior, during and after operation.

CAUTION

Remove any swarf or dust which may have collected on the terminals.

Failure to do so may result in malfunction.

5. Cleaning on the outside

When the power tool is stained, wipe with a soft dry cloth or a cloth moistened with soapy water. Do not use chloric solvents, gasoline or paint thinner, for they melt plastics.

6. Storage

Store the power tool and battery in a place in which the temperature is less than 40°C and out of reach of children.

NOTE

Storing lithium-ion batteries.

Make sure the lithium-ion batteries have been fully charged before storing them.

Prolonged storage (3 months or more) of batteries with a low charge may result in performance deterioration, significantly reducing battery usage time or rendering the batteries incapable of holding a charge.

However, significantly reduced battery usage time may be recovered by repeatedly charging and using the batteries two to five times.

If the battery usage time is extremely short despite repeated charging and use, consider the batteries dead and purchase new batteries.

CAUTION

In the operation and maintenance of power tools, the safety regulations and standards prescribed in each country must be observed.

Important notice on the batteries for the HiKOKI cordless power tools

Please always use one of our designated genuine batteries. We cannot guarantee the safety and performance of our cordless power tool when used with batteries other than these designated by us, or when the battery is disassembled and modified (such as disassembly and replacement of cells or other internal parts).

NOTE

Due to HiKOKI's continuing program of research and development, the specifications herein are subject to change without prior notice.

TROUBLESHOOTING

Use the inspections in the table below if the tool does not operate normally. If this does not remedy the problem, consult your dealer or the HiKOKI Authorized Service Center.

1. Power tool

Symptom	Possible cause	Remedy
Tool doesn't run	No remaining battery power	Charge the battery.
	The trigger switch was held down while the battery was inserted.	The safety function was activated. If the trigger switch is released once and then pulled again, the tool will run.
Tool suddenly stopped	Tool was overburdened.	Get rid of the problem causing the overburden.
	The battery is overheated.	Let the battery cool down.
	The trigger switch was held down for 5 minutes or more.	This is not a malfunction. The motor was automatically stopped to prevent failure of the tool.
Tool bits -can't be attached -fall off	The shape of the attachment portion doesn't match.	Use a bit with a hexagonal shaft that has a width across flats of 6.35 mm.
		If you are using an L-type tool bit, replace it with an S-type bit.
Switch can't be pulled.	Forward/reverse selector button is positioned halfway.	Press the button firmly into position for the desired direction of rotation.
An abnormal high-pitched noise occurs when the trigger switch is pulled.	The trigger switch is being pulled only slightly.	This is not a malfunction. It does not occur if the trigger switch is pulled more fully.
Screw head slips or comes loose.	Bit number doesn't match with the screw size.	Install a suitable bit.
	The bit is worn.	Replace with a new bit.

2. Charger

Symptom	Possible cause	Remedy
The charge indicator lamp rapidly flickers purple, and battery charging doesn't begin.	The battery is not inserted all the way.	Insert the battery firmly.
	There is foreign matter in the battery terminal or where the battery is attached.	Remove the foreign matter.
The charge indicator lamp blinks red, and battery charging doesn't begin.	The battery is not inserted all the way.	Insert the battery firmly.
	The battery is overheated.	If left alone, the battery will automatically begin charging if its temperature decreases, but this may reduce battery life. It is recommended that the battery be cooled in a well-ventilated location away from direct sunlight before charging it.
Battery usage time is short even though the battery is fully charged.	The battery's life is depleted.	Replace the battery with a new one.
The battery takes a long time to charge.	The temperature of the battery, the charger, or the surrounding environment is extremely low.	Charge the battery indoors or in another warmer environment.
	The charger's vents are blocked, causing its internal components to overheat.	Avoid blocking the vents.
	The cooling fan is not running.	Contact a HiKOKI Authorized Service Center for repairs.

一般安全規則

⚠ 警告

閱讀所有安全警告說明

未遵守警告與說明可能導致電擊、火災或其他嚴重傷害。

請妥善保存本使用說明書，以供未來參考之用。

「電動工具」一詞在警告中，係指電源操作（有線）之電動工具或電池操作（無線）之電動工具。

1) 工作場所安全

- a) 保持工作場所清潔及明亮。
雜亂或昏暗的區域容易發生意外。
- b) 勿在易產生爆炸之環境中操作，譬如有易燃液體、瓦斯或粉塵存在之處。
電動工具產生火花會引燃粉塵或煙氣。
- c) 當操作電動工具時，確保兒童及過往人員遠離。
分神會讓您失去控制。

2) 電氣安全

- a) 電動工具插頭必須與插座配合，絕不可以任何方法修改插頭，且不得使用任何轉接插頭於有接地之電動工具。
不修改插頭及所結合之插座，可減少電擊。
- b) 避免身體接觸到地面，諸如管子、散熱器、爐灶及冰箱。
如果您的身體接地或觸地，會增加電擊的危險。
- c) 勿讓電動工具淋雨或曝露在潮濕的環境下。
電動工具進水會增加電擊的危險。
- d) 勿濫用電源線。請勿使用電源線去纏繞、拖拉電動工具或拔插頭，保持電源線遠離熱氣、油氣、尖角或可動零件。
損壞或纏繞的電源線會增加電擊之危險。
- e) 電動工具在室外操作時，請務必使用適合室外用的延長線。
使用合適之室外用延長線會減少電擊的危險。
- f) 若無法避免在潮濕地區操作電動工具，請使用以漏電斷路器 (RCD) 來保護電源。
使用 RCD，可降低觸電危險。

3) 人員安全

- a) 保持機警，注意您正在做什麼，並運用正確常識操作電動工具。
當你感到疲勞或受藥品、酒精或醫療影響時，請勿操作電動工具。
操作中瞬間的不注意，可能造成人員嚴重的傷害。

- b) 使用個人防護裝備，經常配戴安全眼鏡。
配戴防塵口罩、防滑安全鞋、硬帽等防護裝備，或在適當情況下使用聽覺防護，可減少人員傷害。
 - c) 防止意外發生。在連接電源或電池組、拿起或攜帶工具前，請確認開關是在「off」（關閉）的位置。
以手指放在開關握持電動工具，或在電動工具的開關於“on”的狀況下插上插頭，都會導致意外發生。
 - d) 在電動工具啟動前，先卸下任何調整用鑰匙或扳手。
扳手或鑰匙遺留在電動工具的轉動部位時，可能導致人員傷害。
 - e) 身體勿過度伸張，任何時間要保持站穩及平衡。
以便在不預期的狀態下，能對電動工具有較好的控制。
 - f) 衣著要合宜，別穿太鬆的衣服或戴首飾。
保持你的頭髮、衣服及手套遠離轉動部位。
寬鬆的衣服、手飾及長髮會被捲入轉動部位。
 - g) 如果裝置要用於粉塵抽取及集塵設施，要確保其連接及正當使用。
使用集塵裝置可減少與灰塵相關的危險。
 - h) 請勿因頻繁使用本工具，熟悉操作而忽略本工具的安全原則。
粗心的行動有可能瞬間即造成嚴重傷害。
- #### 4) 電動工具之使用及注意事項
- a) 勿強力使用電動工具，使用正確之電動工具為您所需。
正確使用電動工具，會依其設計條件，使工作做得更好更安全。
 - b) 如果開關不能轉至開或關的位置，勿使用電動工具。
任何電動工具不能被開關所控制是危險的，必須要修理。
 - c) 進行任何調整、更換配件或收存電動工具時，必須將插頭與電源分開，且需將電池組從電動工具中取出。
此種預防安全措施，可減少意外開啟電動工具之危險。
 - d) 收存停用之電動工具，需遠離兒童，且不容許不熟悉電動工具或未瞭解操作電動工具說明的人操作電動工具。
在未受過訓練的人手裡，電動工具極為危險。
 - e) 保養電動工具，檢查是否可動零件有錯誤的結合或卡住、零件破裂及可能影響電動工具操作的任何其他情形。
電動工具如果損壞，在使用前要修好。
許多意外皆肇因於不良的保養。

- f) 保持切割工具銳利清潔。
適當的保養切割工具，保持銳利之切割鋒口，可減少卡住並容易控制。
- g) 按照說明書使用電動工具、配件及刀具時，必須考量工作條件及所執行之工作。
若未依照這些使用說明操作電動工具時，可能造成相關之危害情況。
- h) 保持把手和握持面乾燥、清潔，且未沾到油脂和潤滑油。
滑溜的把手和握持面在操作時會有安全上的問題，且可能造成本工具意外失去控制。

5) 電池式電動工具的使用及注意事項

- a) 需再充電時，僅能使用製造商指定的充電器。
因充電器僅適合同一型式的電池組，若使用任何其它電池組時，將導致起火的危險。
- b) 使用電動工具時，僅能使用按照其特性設計的電池組。
因使用其它任何電池組時，將導致人員傷害及起火的危險。
- c) 當電池組不再使用時，需保存好並遠離其它的金屬物件，例如：迴紋針、錢幣、鑰匙、圖釘、螺釘，或類似能造成端子與端子間連接的其它較小金屬物件。
因電池組端子間短路時，將導致燃燒或起火的危險。
- d) 在誤用情況下，電解液可能自電池中噴出；請避免接觸。當發生意外接觸時，請用清水沖洗。若電解液觸及眼睛時，請儘速尋求醫療協助。因自電池中噴出的電解液，將導致灼傷或刺激皮膚。
- e) 請勿使用損壞或改造的電池組或電動工具。
損壞或改造的電池可能會發生不可預知的行為，進而導致火災、爆炸或受傷的風險。
- f) 請勿使電池組或電動工具接觸到火源或處於溫度過高的地方。
接觸火源或溫度超過 130°C 可能會引起爆炸。
- g) 請遵循所有充電指示，並且不要在說明書指定的溫度範圍之外為電池組或電動工具充電。
充電不當或溫度超出指定範圍可能會損壞電池並增加火災的風險。

6) 維修

- a) 讓您的電動工具由合格修理人員僅使用相同的維修零件更換。
如此可確保電動工具的安全得以維持。
- b) 切勿對損壞的電池組進行維修。
電池組的維修只能由製造商或授權服務維修店進行。

注意事項

不可讓孩童和體弱人士靠近工作場所。
應將不使用的電動工具存放在孩童和體弱人士伸手不及的地方。

充電式衝擊起子機安全注意事項

進行緊固件可能接觸到暗線的操作時，請握著電動工具的絕緣手柄表面。接觸到“通電”電線的緊固件可能使電動工具的金屬零件“通電”，而造成操作人員觸電。

附加安全警告

1. 本產品為用於旋緊和旋鬆螺絲、螺栓和螺帽的可攜式工具。請僅將本工具用於這些操作。
2. 操作時請務必牢牢地握住本工具。否則可能會導致事故或受傷。(圖 11)
3. 確保電池安裝牢固。如果電池鬆動，可能會脫落而造成事故。
4. 準備和檢查工作環境。確保工作場所符合注意事項中所規定的全部條件。
5. 請勿讓異物進入充電電池連接口內。
6. 切勿拆卸充電電池與充電器。
7. 切勿使充電電池短路。電池短路會造成極大電流和過熱。從而燒壞電池。
8. 請勿將電池丟入火中。燃燒電池會引起爆炸。
9. 充電後電池壽命若太短不夠使用，請盡快將電池送往經銷店。不可將用過的電池丟棄。
10. 請勿將異物插入充電器的通風口。若將金屬異物或易燃物插入通風口的話，將會引起觸電事故或使充電器受損。
11. 使用扭力扳手確認實際的旋緊力矩。
12. 切換旋轉方向之前，請先停止工具。切換旋轉方向之前，請務必先釋放開關並等待工具停止。
13. 切勿觸摸旋轉部件。請勿讓旋轉部件區域靠近手或身體的任何其他部位。有可能會被割傷或卡在旋轉部件裡。此外，長時間連續使用後，請小心不要觸摸到旋轉部件。旋轉部件會變得非常燙，有可能會燙傷您。
14. 請使用本使用說明書和 HiKOKI 產品目錄中所列出的指定附件。否則可能導致事故或受傷。
15. 確保將附件牢固地安裝在鐵砧。如果附件未安裝牢固，可能會脫落而導致受傷。
起子鑽頭安裝完畢之後，請輕輕地將鑽頭向外拉動，確保其不會在使用過程中鬆動。若導筒沒有返回原來的位位置，表示鑽頭未正確安裝。
16. 連續使用機組後應讓工具休息。
17. 本電動工具配備有溫度保護電路以保護馬達。連續作業可能會導致工具的溫度上升，啟動溫度保護電路及自動停止操作。如果發生這種情況，請讓電動工具降溫後再使用。
18. 本工具過載的情況下，馬達可能會停止。這種狀況發生時，請釋放工具的開關並消除造成過載的原因。
前殼體在連續作業期間會變熱，請避免碰觸。

- 在寒冷的條件下使用電池（低於攝氏 0 度），有時可能會導致減弱鎖緊扭矩和工作量減少。但這是一種暫時的現象，當電池升溫後即恢復正常。
- 確保掛鉤安裝牢固。否則使用時可能會造成傷害。欲將工具吊掛於腰帶攜帶時，請務必取下工具鑽頭和邊杆。否則可能會導致意外的人體傷害。
- 切勿觸摸金屬部分，連續操作後金屬部分會變得很快。
- 請勿直視燈泡。若直視，可能會導致眼睛受傷。用軟布擦去附著在 LED 鏡頭上的灰塵或污垢，注意不要刮傷鏡頭。LED 鏡頭上的刮痕可能會導致亮度下降。
- 如果工具或電池端子（電池座）變形，請勿使用本產品。安裝電池可能會造成短路，從而導致冒煙或起火。
- 保持工具的端子（電池座）沒有削屑和灰塵。
 - 使用前請確認端子區域沒有堆積削屑和灰塵。
 - 使用過程中盡量避免工具上的削屑或灰塵掉落在電池上。
 - 暫停操作或使用後，請勿將工具留在可能暴露於有掉落削屑或灰塵的區域。否則可能會造成短路，從而導致冒煙或起火。
- 務必在 -5°C 至 40°C 的溫度下使用本工具和電池。
- 務必在 0-40°C 的溫度環境下進行充電。

鋰離子電池使用注意事項

為延長使用壽命，鋰離子電池備配停止輸出的保護功能。

若是在使用本產品時發生下列 1 至 3 的情況，即使按下開關，馬達也可能停止。這並非故障，而是啟動保護功能的結果。

- 在殘留的電池電力即將耗盡時，馬達會停止。在這種情況下，請立即予以充電。
- 若工具超過負荷，馬達亦可能停止。在這種情況下，請鬆開工具的開關，試著消除超過負荷的原因。之後您就可以再度使用。
- 若電池在過載工作情況下過熱，電池電力可能會中止。在這種情況下，請停止使用電池，讓電池冷卻。之後您就可以再度使用。

此外，請留心下列的警告及注意事項。

警告

為事先防止電池發生滲漏、發熱、冒煙、爆炸及起火等事故，請確保留意下列事項。

- 確保電池上沒有堆積削屑及灰塵。
 - 在工作時確定削屑及灰塵沒有掉落在電池上。
 - 確定所有工作時掉落在電動工具上的削屑和灰塵沒有堆積在電池上。
 - 請勿將未使用的電池存放在曝露於削屑和灰塵的位置。

- 在存放電池之前，請清除任何可能附著在上面的削屑和灰塵，並請切勿將它與金屬零件（螺絲、釘子等）存放在一起。
- 請勿以釘子等利器刺穿電池、以鐵錘敲打、踩踏、丟擲電池，或將其劇烈撞擊。
- 切勿使用明顯損壞或變形的電池。
- 使用電池時請勿顛倒電極。
- 請勿直接連接電源插座或汽車點煙器孔座。
- 請依規定方式使用電池，切勿移作他用。
- 如果已過了再充電時間，電池仍無法完成充電，請立即停止繼續充電。
- 請勿將電池放置於高溫或高壓處，例如微波爐、烘乾機或高壓容器內。
- 發現有滲漏或異味時，請立即將電池遠離火源處。
- 請勿在會產生強烈靜電的地方使用。
- 如電池出現滲漏、異味、發熱、褪色或變形，或在使用、充電或存放時出現任何異常，請立即將它從裝備或電池充電器拆下，並停止使用。
- 請勿將電池浸入任何液體，或讓任何液體流入電池內。若水等具有傳導性的液體滲入，可能會造成損壞，進而導致火災或爆炸。將電池存放在陰涼、乾燥的地方，遠離可燃及易燃物品。必須避免腐蝕性氣體環境。

注意

- 若電池滲漏出的液體進入您的眼睛，請勿搓揉眼睛，並以自來水等乾淨清水充分沖洗，立刻送醫。若不加以處理，液體可能會導致眼睛不適。
- 若液體滲漏至您的皮膚或衣物，請立即以自來水等清水沖洗。上述情況可能會使皮膚受到刺激。
- 若初次使用電池時發現生鏽、異味、過熱、褪色、變形及／或其他異常情況時，請勿使用並將該電池退還給供應商或廠商。

警告

若具有導電性的異物進入鋰離子電池的端子，可能會造成短路，進而引發火災。請在存放電池時遵循以下事項。

- 請勿將導電物品，如鐵釘、鐵絲等金屬絲，銅線和電線放入儲存箱內。
- 為了防止發生短路，將電池裝入工具內或確實壓下電池蓋儲存電池，直至遮住通風孔為止。

關於鋰離子電池的運輸

運輸鋰離子電池時，請遵守以下注意事項。

警告

安排運輸時，請通知運輸公司包裹中含有鋰離子電池，告知該電池之輸出功率，並按照運輸公司的指示。

- 輸出功率超過 100 Wh 的鋰離子電池被視為貨物分類中的危險物品，將需要特殊的申請程序。
- 對於國外的運輸，必須遵守國際法規則和目的國法規。

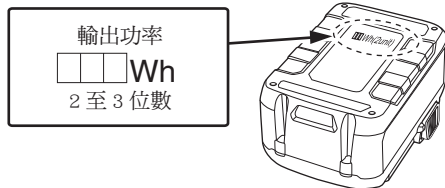

關於防塵和防水功能的注意事項

本產品符合國際 IEC 法規所規定的電氣設備 IP56 防護等級（防塵和防水）。（裝有電池時，僅主裝置符合 IP56 防護等級。）

[IP 代碼的說明]

IP56

↪ 滲水的防護等級

水從各方向強力噴射時，對設備不得有任何不良影響（防水）。

（使用直徑 12.5 mm 的噴嘴從約三公尺的距離每分鐘噴射 100 L 的水，噴射時間約三分鐘。）

↪ 固體外來物質侵入的防護等級

不得讓可能對設備造成不良影響的灰塵進入（防塵）。

（設備以非運作狀態放置於試驗室內，並在試驗室內使用攪拌泵浦以每立方公尺 2 公斤的速率使空氣中飄浮直徑小於 75 μm 的滑石粉顆粒約八小時。）

本設備之設計可防止灰塵和水，但恕不保證不會發生故障。請勿在有過量灰塵、浸水或容易受到雨淋的地方使用或放置本設備。

各部位名稱（圖1-圖11）



① 保護器	⑬ 卡榫
② 錘殼	⑭ 充電指示燈
③ 導筒	⑮ 起子鑽頭（另售）
④ LED 燈	⑯ 凹槽
⑤ 觸發開關	⑰ 螺絲
⑥ 開關面板	⑱ 剩餘電池電量指示開關
⑦ 電池	⑲ 電池剩餘量指示燈
⑧ 掛鉤	⑳ 顯示屏
⑨ 握把	㉑ 燈光分段開關
⑩ 按鈕	㉒ 旋緊模式選擇器開關
⑪ 機殼	㉓ 旋緊模式指示燈
⑫ 色板（另售）	





符號

警告

以下為使用於本機器的符號。請確保您在使用前明白其意義。

	WH18DC: 衝擊起子機
	使用前請詳讀使用說明書。
	直流電流
V	額定電壓
n ₀	無負荷速度
/min	每分鐘振動
P _m	強力模式
B _{Sm}	螺栓單模式
B _m	螺栓模式
S _m	減弱模式

	自鑽螺絲模式
	衝擊率
	小型螺絲
	普通螺絲
	高張力螺絲
	自鑽螺絲
	旋緊力矩 (最大)
	六角起子尺寸
	重量
	開關ON
	開關OFF
	取出電池
	燈光分段開關
	順時針旋轉
	逆時針旋轉
	剩餘電池電量指示開關
	亮起： 電池剩餘電量超過 75%。
	亮起： 電池剩餘電量為 50% - 75%。
	亮起： 電池剩餘電量為 25% - 50%。
	亮起： 電池剩餘電量少於 25%。
	閃爍： 電池剩餘電量幾近零。請盡快進行充電。
	閃爍： 由於高溫導致輸出被暫停。從工具中取出電池，並使其完全冷卻。
	閃爍： 由於故障或機能失常導致輸出被暫停。問題可能是電池，請聯繫您的經銷商。
	旋緊模式選擇器開關
	旋緊模式指示燈

	亮燈：「細膩作業」 小直徑機器螺絲 (M6 級) 等
	亮燈：「從正常作業到重負載作業」 全部的螺絲、長型螺絲、方頭螺絲
	亮燈：「旋緊和旋鬆螺帽和螺絲」
	閃爍：「細膩作業」 用於機架、柵欄、家具等的螺絲
	亮燈： 自鑽螺絲
	警告

標準附件

除了主機身 (1 台) 以外，包裝盒內包含第 23 頁所列之附件。

標準附件可能不預先通告而徑予更改。

用途

旋入與卸下機器螺絲、木螺絲、自攻螺絲等。

規格

本機器的規格列於第 23 頁的表中。

註

為求改進，本手冊所載規格可能不預先通告而徑予更改。

充電

使用電動工具之前，按下述方法將電池進行充電。

- 將充電器的電源線纜連接到插座。
插頭接上插座時，信號燈會閃爍紅燈 (閃爍間隔時間為 1 秒)。
 - 將電池裝入充電器。
將電池確實插入充電器如圖 3 (第 2 頁) 所示。
 - 充電
當電池插入充電器時，充電信號燈會閃爍藍燈。
當電池完全充電時，充電信號燈會亮起綠燈。(見表 1)
- (1) 充電信號燈指示
依據充電器或電池的狀態，充電信號燈會有不同的指示，如表 1 所示。

表 1

充電信號燈的指示				
充電信號燈 (紅 / 藍 / 綠 / 紫)	充電前	閃爍 (紅)	亮起 0.5 秒，熄滅 0.5 秒。(熄滅間 0.5 秒)	插入電源
	充電時	閃爍 (藍)	亮起 0.5 秒，熄滅 1 秒。(熄滅間 1 秒)	電池容量少於 50%
		閃爍 (藍)	亮起 1 秒，熄滅 0.5 秒。(熄滅間 0.5 秒)	電池容量少於 80%
		亮起 (藍)	持續亮起	電池容量超過 80%
	充電完成	亮起 (綠)	持續亮起 (連續的蜂鳴聲：約 6 秒)	
	過熱待機	閃爍 (紅)	亮起 0.3 秒，熄滅 0.3 秒。(熄滅間 0.3 秒)	電池過熱。 無法充電。 (待電池降溫後便會開始充電)
	無法充電	快速閃爍 (紫)	亮起 0.1 秒，熄滅 0.1 秒。(熄滅間 0.1 秒) ■ ■ ■ ■ ■ ■ ■ ■ ■ ■ ■ ■ ■ ■ ■ ■ (間歇的蜂鳴聲：約 2 秒)	電池或充電器故障

(2) 關於充電電池的溫度和充電時間
溫度和充電時間如表 2 中所示。

表 2

充電器		UC18YSL3					
電池	電池類型	Li-ion					
	電池可充電的溫度	0°C - 50°C					
	充電電壓	V		14.4		18	
	充電時間， 約 (於 20°C)	分鐘	BSL14xx 系列		BSL18xx 系列		多伏特系列
			(4 個電池芯)	(8 個電池芯)	(5 個電池芯)	(10 個電池芯)	(10 個電池芯)
			BSL1415S : 15 BSL1415 : 15 BSL1415X : 15 BSL1420 : 20 BSL1425 : 25 BSL1430C : 30	BSL1430 : 20 BSL1440 : 26 BSL1450 : 32 BSL1460 : 38	BSL1815S : 15 BSL1815 : 15 BSL1815X : 15 BSL1820 : 20 BSL1825 : 25 BSL1830C : 30 BSL1840M : 40 BSL1850C : 32	BSL1830 : 20 BSL1840 : 26 BSL1850 : 32 BSL1850MA : 32 BSL1860 : 38	BSL36A18 : 32 BSL36B18 : 52

註：
根據環境溫度和電源電壓，充電時間可能會有所不同。

- 將充電器的電源線從插座拔下。
- 拿穩充電器並取出電池。

註：
充電結束後，務必從充電器取出電池，然後妥善存放。

怎樣讓電池使用時間更長。

- 在電池電量完全耗盡之前給電池充電。
在感覺工具的動力變弱時，停止使用工具並為電池充電。如果繼續使用工具消耗電流，可能會造成對電池的損壞，電池使用壽命會縮短。
- 避免在高溫下充電。
充電電池在剛使用後會發熱。如果在電池剛使用後為電池充電，電池的內部化學物質的性能會下降，電池使用壽命會縮短。請先將電池放置一會兒，待電池冷卻後再進行充電。

使用新電池或其他電池，產生電量較弱的問題時。

由於新電池及長時間未使用之電池的內部化學物質未活化，因此初次及第二次使用時的電量會較弱。此為暫時現象；在充電 2 至 3 次後，電量就會恢復正常。

注意

- 電池因長時間放置在直射陽光處遭到日曬或剛使用後會發熱，若在此時進行充電，充電器的信號燈會亮起 0.3 秒，非亮起 0.3 秒（熄滅 0.3 秒）。此時您必須先待電池冷卻，再進行充電。
- 充電信號燈快速閃爍時（間隔時間為 0.2 秒），請檢查充電器的電池連接處是否有異物並加以清除。若沒有異物，則表示電池或充電器可能發生故障，請將其送往當地授權服務中心。
- 由於 UC18YSL3 內置微電腦需要約 3 秒的時間確認進行充電的電池已被取出，請等待至少 3 秒後再將電池重新插入繼續充電。如果電池在 3 秒之內重新插入，電池可能無法正常充電。

安裝和操作

動作	圖表	頁數
拆卸和安裝電池	2	2
充電	3	2
安裝鑽頭	4	2
逆轉旋轉方向	5	2
開關操作	6	3
掛鉤的拆卸和安裝	7	3
電池剩餘電量指示器	8	3
使用 LED 燈 *1	9	3
旋緊模式選擇器功能 *2	10	4
選擇附件	—	24

*1 使用 LED 燈

註

- 按下開關面板上的燈光分段開關，可將LED燈的亮燈模式更改為「始終開啟」→「SW互鎖」→「關閉」。
- 為了節省電池電量，務必盡可能關閉燈光。
- 為防止因忘記關閉LED燈而消耗電池的電量，燈光會在約2分鐘後自動熄滅。

*2 旋緊模式選擇器功能

注意

在觸發開關釋放時選擇旋緊模式。否則可能會導致故障。

透過使用旋緊模式選擇器開關，可根據作業類型來調整旋緊力矩。

每次按下旋緊模式選擇器開關，可在 5 種不同模式之間切換旋緊模式。

在螺栓單模式下扳動觸發開關時，驅動器將在施加一些衝擊力後自動停止。

減弱／強力／螺栓和自鑽螺絲模式將在扳動觸發開關時開始產生衝擊力，並且將連續施加衝擊力而不會自動停止。

減弱模式是一種不會對細釘子或裝飾材料造成損害的模式。

強力模式可用於正常作業至重負載作業。

螺栓模式的觸發開關扳動裕度短，使驅動器非常適合高速旋緊作業。

螺栓單模式可控制衝擊力，從而能夠控制旋緊力。使用此模式進行細膩作業，例如旋緊用於機架、柵欄、家具等的螺栓。

自鑽螺絲模式可降低因過度旋緊而導致螺絲頭裂開、螺絲損壞或滑動的可能性，非常適合旋緊自鑽螺絲。

註

- 合適的模式根據螺絲類型和要旋緊的材料而異。旋入一些測試用螺絲，並根據結果調整模式的設定。
- 只能在起子機已安裝電池且拉動一次觸發開關之後，才可以進行旋緊模式選擇器開關的設定。

LED 燈警示信號 (圖 12)

該產品配備有保護工具本身及電池的功能。開關被拉動的同時，若在操作期間有任何的保護功能被啟動，LED 燈將閃爍如表 3 所述。當有任何的保護功能被啟動時，請立即從開關上移開手指，並按照下述校正動作的指示。



圖 12

表 3

保護功能	LED 燈顯示	校正動作
溫度保護	亮起 0.3 秒 / 熄滅 0.3 秒 ■ ■ ■ ■	使工具和電池徹底冷卻。

維護和檢查

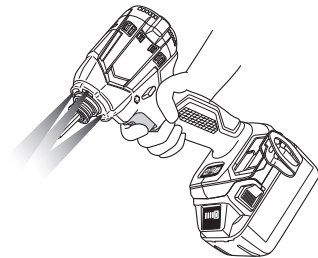
1. 檢查起子鑽頭
使用破損的鑽頭或尖端磨損的鑽頭是非常危險的，因為鑽頭可能滑動。應立即更換。
2. 檢查安裝螺釘
要經常檢查安裝螺釘是否緊固妥善。若發現螺釘鬆了，應立即重新扭緊，否則會導致嚴重的事務。
3. 電動機的維護
電動機繞線是電動工具的心臟部。應仔細檢查有無損傷，是否被油液或水沾濕。
4. 端子的檢查（工具和電池）
檢查以確保端子上沒有堆積削屑和灰塵。
有時於操作前、操作期間和操作後檢查。

注意

去除任何可能已堆積在端子上的削屑或灰塵。
否則可能會導致故障。

5. 清理外部
電動工具髒汙時，請使用乾淨軟布或沾肥皂水的布擦拭。切勿使用氯溶液、汽油或稀釋劑，以免塑膠部分溶化。
6. 收藏
電動工具和電池應收藏於溫度低於 40°C 而為小孩拿不到的地方。

註

存放鋰離子電池

存放鋰離子電池前，確保其已完全充電。
電池在低電力的狀態下長期存放（3 個月以上），可能會導致性能劣化，電池的使用時間顯著降低或無法再進行充電。

然而，反覆將電池充電和暫停充電二至五次，可能會改善電池使用時間的顯著降低情況。
反覆充電後，若電池的使用時間仍呈現極短現象，表示電池壽命已盡，請購買新的電池。

注意

在操作和維修電動工具中，必須遵守各國的安全規則和標準規定。

HiKOKI 充電式工具電池重要注意事項

請務必使用本公司所指定的原廠電池。若未使用本公司所指定的電池，或使用經拆解及改裝的電池（例如，拆解後更換電池芯或其他內部零件），則本公司無法保證充電式工具的性能及操作安全。

註：

為求改進，本手冊所載規格可能不預先通告而徑予更改。

疑難排解

若電動工具無法正常運作，請參閱下表的檢查項目。若問題仍無法解決，請洽當地經銷商或 HiKOKI 所認可的維修中心。



1. 電動工具

情況	可能原因	解決方法
工具無法運轉	無剩餘電池電量	為電池充電。
	觸發開關在電池插入時被按住。	安全功能已啟動。 釋放觸發開關一次然後再重新拉動，工具將會運作。
工具突然停止	工具負擔過重	除去造成工具負擔過重的問題。
	電池過熱。	讓電池冷卻下來。
	觸發開關已被按住 5 分鐘以上。	這不是故障。 馬達為防止工具故障而自動停止。
工具鑽頭 - 無法安裝 - 脫落	安裝部的形狀不相配	使用對邊寬度為 6.35 mm 的六角軸鑽頭。
		如果您正在使用 L 型工具鑽頭，請將其更換為 S 型鑽頭。
開關無法拉動	正轉 / 逆轉選擇按鈕位於中間	將按鈕牢固地按入所希望轉動方向的位置。
拉動觸發開關時產生異常尖銳的噪音。	觸發開關僅被稍微拉動。	這不是故障。 充分拉動觸發開關就不會產生該噪音。
螺絲頭滑動或鬆開。	鑽頭號碼與螺絲尺寸不相配	安裝合適的鑽頭。
	鑽頭已磨損	更換新的鑽頭。

2. 充電器

情況	可能原因	解決方法
充電指示燈迅速閃爍紫色，且電池不開始充電。	電池未完全插入。	牢固地插入電池。
	電池端子內或電池安裝處有異物。	移除異物。
充電指示燈閃爍紅色，且電池不開始充電。	電池未完全插入。	牢固地插入電池。
	電池過熱。	若放著不管，當電池溫度降低後就會自動開始充電，但這可能會縮短電池的壽命。建議在充電前將電池放在遠離陽光直射且通風良好的位置進行冷卻。
即使電池已充滿電，電池的使用時間仍然很短。	電池壽命已耗盡。	更換新的電池。
電池的充電時間很長。	電池、充電器或周圍環境的溫度非常低。	在室內或其他較溫暖的環境進行電池的充電。
	充電器的通風口被堵塞，造成其內部組件過熱。	避免堵塞通風口。
	冷卻風扇未運轉。	聯繫 HiKOKI 授權服務中心以進行修理。

		WH18DC	
V	V	18	
n ₀	Pm	/min	0-3400
	Bm/BSm	/min	0-2900
	Sm	/min	0-900
	SEm	/min	0-3700
	mm	4-10	
	mm	M5-M18	
	mm	M5-M14	
	mm	φ3.5-φ6	
MT	N · m	210	
	mm	6.35 (1/4")	
	kg	1.6 (BSL1850MA attached)	

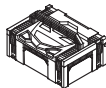
		WH18DC
		(2JCP)
	UC18YSL3	1
	BSL1850MA	2
		1
		1

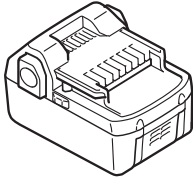

BSL18..

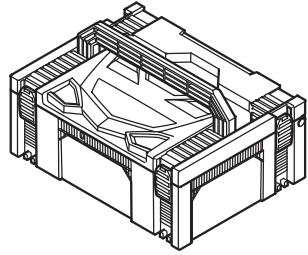

336471

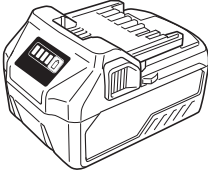

BSL36..18

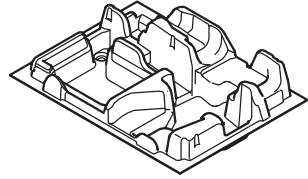

339776

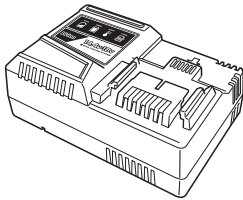

UC18YSL3 (14.4 V-18 V)

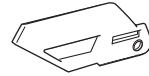

- Light Gold: 377857
- Titanium Silver: 377858
- Sky Blue: 377859
- Violet: 377860
- Signal Red: 377861

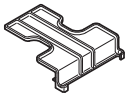

329897

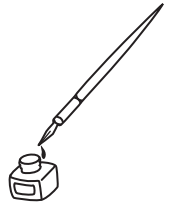

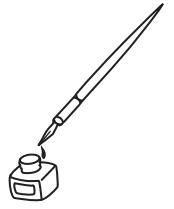

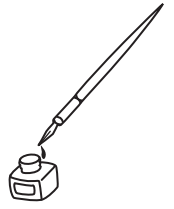

Koki Holdings Co., Ltd.

Shinagawa Intercity Tower A, 15-1, Konan 2-chome,
Minato-ku, Tokyo, Japan