

HIKOKI

充电式冲击起子机 Cordless Impact Driver

WH 18DC

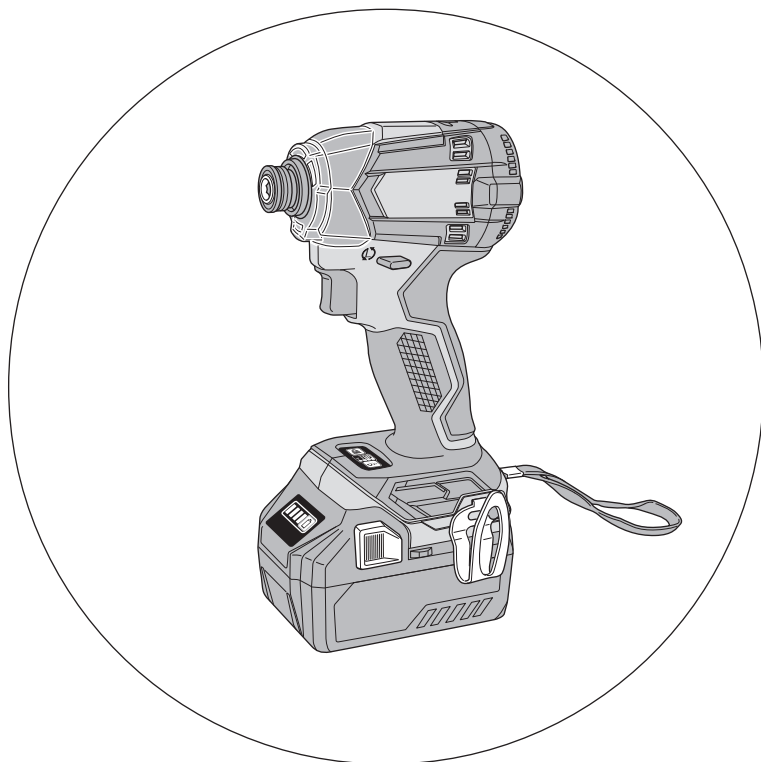

保留备用
Keep for future reference



使用说明书
Handling instructions

目次

电动工具通用安全警告.....	2	电池的拆卸 / 安装法.....	11
充电式冲击起子机安全警告.....	5	充电.....	11
锂离子电池使用注意事项.....	6	作业之前.....	14
锂离子电池运输.....	7	使用方法.....	15
USB 设备连接器使用注意事项.....	7	操作上的注意事项.....	20
防尘和防水功能注意事项.....	8	USB 设备的充电方法.....	21
符号.....	8	维护和检查.....	22
规格.....	9	故障排除.....	23
标准附件.....	10	选择附件.....	26
用途.....	10		

电动工具通用安全警告

⚠ 警告！

阅读电动工具附带的所有安全警告、说明、插图和规格说明。
不遵照以下说明会导致电击、着火和 / 或严重伤害。

保存所有警告和说明书以备查阅。

在所有下列的警告中术语“电动工具”指市电驱动（有线）电动工具或电池驱动（无线）电动工具。

1) 工作场地的安全

- a) 保持工作场地清洁和明亮。
混乱和黑暗的场地会引发事故。
- b) 不要在易爆环境，如有易燃液体、气体或粉尘的环境下操作电动工具。
电动工具产生的火花会点燃粉尘或气体。
- c) 让儿童和旁观者离开后操作电动工具。
注意力不集中会使操作者失去对工具的控制。

2) 电气安全

- a) 电动工具插头必须与插座相配。绝不能以任何方式改装插头。
需接地的电动工具不能使用任何转换插头。
未经改装的插头和相配的插座将减少电击危险。
- b) 避免人体接触接地表面，如管道、散热片和冰箱。
如果你身体接地会增加电击危险。
- c) 不得将电动工具暴露在雨中或潮湿环境中。
水进入电动工具将增加电击危险。

- d) 不得滥用电线。绝不能用电线搬运、拉动电动工具或拔出其插头。使电线远离热源、油、锐边或运动部件。
受损或缠绕的软线会增加电击危险。
- e) 当在户外使用电动工具时，使用适合户外使用的外接软线。
适合户外使用的软线将减少电击危险。
- f) 如果在潮湿环境下操作电动工具是不可避免的，应使用剩余电流动作保护器（RCD）。
使用RCD可减小电击危险。

3) 人身安全

- a) 保持警觉，当操作电动工具时关注所从事的操作并保持清醒。
当你感到疲倦，或在有药物、酒精或治疗反应时，不要操作电动工具。
在操作电动工具时瞬间的疏忽会导致严重人身伤害。
- b) 使用个人防护装置。始终佩戴护目镜。
安全装置，诸如适当条件下使用防尘面具、防滑安全鞋、安全帽、听力防护等装置能减少人身伤害。
- c) 防止意外起动。确保开关在连接电源和 / 或电池盒、拿起或搬运工具时处于关断位置。
手指放在已接通电源的开关上或开关处于接通时插入插头可能会导致危险。
- d) 在电动工具接通之前，拿掉所有调节钥匙或扳手。
遗留在电动工具旋转零件上的扳手或钥匙会导致人身伤害。
- e) 手不要伸展得太长。时刻注意立足点和身体平衡。
这样在意外情况下能很好地控制电动工具。
- f) 着装适当。不要穿宽松衣服或佩戴饰品。让衣服、手套和头发远离运动部件。
宽松衣服、佩饰或长发可能会卷入运动部件中。
- g) 如果提供了与排屑、集尘设备连接用的装置，要确保它们连接完好且使用得当。
使用这些装置可减少尘屑引起的危险。
- h) 请勿因频繁使用工具的熟悉感而掉以轻心，忽视工具的安全性原则。
粗心的行为可能会导致瞬间发生严重伤害。

4) 电动工具使用和注意事项

- a) 不要滥用电动工具，根据用途使用适当的电动工具。
选用适当设计的电动工具会使你工作更有效、更安全。
- b) 如果开关不能接通或关断工具电源，则不能使用该电动工具。
不能用开关来控制的电动工具是危险的且必须进行修理。
- c) 在进行任何调整、更换附件或存放电动工具之前，必须从电源上拔掉插头和 / 或取下电池盒（如果可拆卸）。
这种防护性措施将减少工具意外起动的危险。

- d) 将闲置不用的电动工具贮存在儿童所及范围之外，并且不要让不熟悉电动工具或对这些说明不了解的人操作电动工具。
电动工具在未经培训的用户手中是危险的。
 - e) 维护电动工具和附件。检查运动件是否调整到位或卡住，检查零件破损情况和影响电动工具运行的其他状况。
如有损坏，电动工具应在使用前修理好。
许多事故由维护不良的电动工具引发。
 - f) 保持切削刀具锋利和清洁。
保养良好的有锋利切削刃的刀具不易卡住而且容易控制。
 - g) 按照使用说明书，考虑作业条件和进行的作业来使用电动工具、附件和工具的刀头等。
将电动工具用于那些与其用途不符的操作可能会导致危险。
 - h) 保持手柄和抓握表面干燥、清洁，远离油和油脂。
如果手柄和抓握表面湿滑，可能导致在发生意外情况时，无法安全操作和控制工具。
- 5) 电池式工具使用和注意事项
- a) 只用制造商规定的充电器充电。
将适用于某种电池盒的充电器用到其他电池盒时会发生着火危险。
 - b) 只使用配有特制电池盒的电动工具。
使用其他电池盒会发生损坏和着火危险。
 - c) 当电池盒不用时，将它远离其他金属物体，例如回形针、硬币、钥匙、钉子、螺钉或其他小金属物体，以防一端与另一端连接。
电池端部短路会引起燃烧或火灾。
 - d) 在滥用条件下，液体会从电池中溅出；避免接触。如果无意间碰到了，用水冲洗。如果液体碰到了眼睛，还要寻求医疗帮助。
从电池中溅出的液体会发生腐蚀或燃烧。
 - e) 请勿使用损坏或改装的电池盒或工具。
损坏或改装的电池可能会引发突发状况，导致火灾、爆炸或受伤。
 - f) 请勿将电池盒或工具暴露在有火源或高温环境中。
如果暴露在有火源或 130 度以上高温的环境中，可能引起爆炸。
 - g) 请完全按照充电说明进行操作，不要在说明中规定的温度范围外的环境中对电池盒或工具充电。
充电不当或在规定温度范围外的环境中充电可能会导致电池损坏，增加发生火灾的风险。
- 6) 维修
- a) 将你的电动工具送交专业维修人员，使用同样的备件进行修理。
这样将确保所维修的电动工具的安全性。
 - b) 请勿维修已损坏的电池盒。
需由制造商或经授权的服务供应商进行维修。

注意！

不可让儿童和体弱人士靠近工作场所。

应将不使用的工具存放在儿童和体弱人士接触不到的地方。

充电式冲击起子机安全警告

1. 在执行紧固件可能会接触到暗线的操作时，通过绝缘的抓紧表面拿住电动工具。接触“带电”电线的紧固件会使电动工具的裸露金属部件“带电”，并可能使操作员遭到电击。
2. 本工具为手提式工具，用于旋紧和旋松螺丝。请不要用于其它作业。
3. 如长时间进行作业，请使用耳塞。
4. 单手操作非常危险。操作时请用双手握紧电动工具。
5. 安装好起子机的钻头以后，请轻轻地将钻头往外拉确认钻头是否松弛。如钻头安装得不妥当，在使用时钻头可能会松弛而引起危险。
6. 请使用与螺丝相配的钻头。
7. 用本冲击起子机旋紧螺丝时，如冲击起子机与螺丝之间的位置不成直线，则会损坏螺丝头，同时起子机的旋转力也不能被妥善地传给螺丝。所以，旋紧螺丝时，请使起子机与螺丝成一直线。
8. 务请在0°C—40°C的温度下进行充电。温度低于0°C将会导致充电过度，极其危险。电池不能在高于40°C的温度下充电。
最适合于充电的温度是20—25°C。
9. 不要连续使用充电器。
一次充电完毕后，在15分钟内不要再次使用该充电器对电池充电。
10. 勿让杂质进入电池连结口内。
11. 切勿拆卸电池与充电器。
12. 切勿使电池短路。使电池短路将会造成很大的电流和过热，从而烧坏电池。
13. 请勿将电池丢入火中。
电池受热将会爆炸。
14. 请勿将异物插入充电器的通风口。
若将金属异物或易燃物插入通风口的话，将会引起触电事故或使充电器受损。
15. 充电后电池寿命太短不够使用时，请尽快将电池送往经销店。请勿将用过的电池乱丢。
16. 请勿使用耗竭了的电池，否则会损坏充电器。
17. 请勿使用工具或电池端子（电池安装部位）明显变形的产品。
否则，安装电池后可能会短路，造成冒烟或起火。
18. 请清除工具端子（电池安装部位）上的削屑和灰尘。
 - 使用前请确保电池上没有堆积削屑和灰尘。
 - 在使用过程中，请尽量避免工具上的削屑或灰尘掉落在电池上。
 - 暂时不使用工具时或使用后，应将工具存放在不会掉落削屑或灰尘的地方。
否则可能短路，造成冒烟或起火。

锂离子电池使用注意事项

为延长使用期限，锂离子电池备配停止输出的保护功能。

若是在使用本产品时发生下列 1 至 3 的情况，即使按下开关，马达也可能停止。这并非故障，而是启动保护功能的结果。

1. 在残留的电池电力即将耗尽时，马达会停止。
在这种情况下，请立即予以充电。
 2. 若工具超过负荷，马达亦可能停止。在这种情况下，请松开工具的开关，试着消除超过负荷的原因。之后您就可以再度使用。
 3. 若电池在过载工作情况下过热，电池电力可能会中止。
在这种情况下，请停止使用电池，让电池冷却。之后您就可以再度使用。
- 此外，请留心下列的警告及注意事项。

警告！

为防止发生电池漏电、发热、冒烟、爆炸及提前点燃，请确保留意下列事项。

1. 确保电池上没有堆积削屑及灰尘。
 - 在工作时确定削屑及灰尘没有掉落在电池上。
 - 确定所有工作时掉落在电动工具上的削屑和灰尘没有堆积在电池上。
 - 请勿将未使用的电池存放在曝露于削屑和灰尘的位置。
 - 在存放电池之前，请清除任何可能附着在上面的削屑和灰尘，并请切勿将它与金属零件（螺丝、钉子等）存放在一起。
2. 请勿以钉子等利器刺穿电池、以铁锤敲打、踩踏、丢掷电池，或将其剧烈撞击。
3. 切勿使用明显损坏或变形的电池。
4. 使用电池时请勿颠倒电极。
5. 请勿直接连接电源插座或汽车点烟器孔座。
6. 请依规定方式使用电池，切勿移作他用。
7. 如果已过了再充电时间，电池仍无法完成充电，请立即停止继续再充电。
8. 请勿将电池放置于高温或高压处，例如微波炉、烘干机或高压容器内。
9. 在发觉有渗漏或异味时，请勿接近远离火源。
10. 请勿在会产生强烈静电的地方使用。
11. 如有电池渗漏、异味、发热、褪色或变形，或在使用、充电或存放时出现任何异常，请立即将它从装备或电池充电器拆下，并停止使用。
12. 请勿浸泡电池或让任何液体流入电池内部。导电液体进入（如水），可能造成电池损坏，甚至可导致火灾或爆炸。将电池存放在阴凉、干燥的地方，远离易燃物品。必须避免将电池置于腐蚀性气体环境中。

注意！

1. 若电池渗漏出的液体进入您的眼睛，请勿搓揉眼睛，并以自来水等干净清水充分冲洗，立刻送医。
若不加以处理，液体可能会导致眼睛不适。
2. 若液体渗漏至您的皮肤或衣物，请立即以自来水等清水冲洗。
上述情况可能会使皮肤受到刺激。
3. 若初次使用电池时发现生锈、异味、过热、褪色、变形及 / 或其它异常情况时，请勿使用并将该电池退还给供货商或厂商。

警告！

如果导电异物接触到锂离子电池的端子，电池可能短路，并导致火灾。

存放锂离子电池时，请务必遵循下列注意事项。

- 切勿在存放盒中放置导电的残片，钉子，以及导线，如铁线和铜线。
- 或者将电池装在电动工具中，或者在牢固按入电池盖并挡住通风孔后再存放，以防止短路。（参照图 1）



图 1

锂离子电池运输

当运输一个锂离子电池，请注意以下预防措施。

警告！

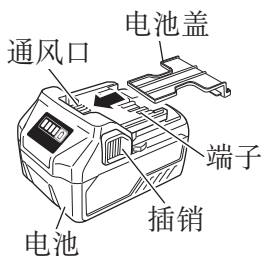
告知运输公司，包装内包含一个锂离子电池，告知该公司其功率输出并且要按照运输公司的指引安排运输。

- 功率输出超过 100Wh 的锂离子电池被视作危险物品运输分类并且需要特别申请程序。
- 对于境外运输，您必须遵守国际法以及输入国的规章和条例。



图 2

USB设备连接器使用注意事项

发生意外情况时，本产品连接的 USB 中保存的数据可能发生损坏或丢失。使用本产品前，请务必备份 USB 设备中的数据。

请注意，如 USB 设备中存储的数据发生损坏、丢失或连接的设备发生损坏，本公司概不负责。

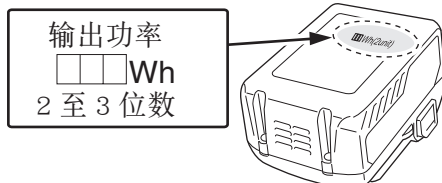
防尘和防水功能注意事项

本产品符合国际 IEC 标准中规定的电气设备 IP56 防护等级（防尘和防水）。（装有电池时，仅重要的组件符合 IP56 防护等级。）

[IP 代码描述]

IP56



防水等级

强水流从各方向喷射时务必不会对设备产生不良影响（防水）。
（使用直径 12.5mm 的喷嘴时，请在距离 3 米左右处进行喷射，每分钟喷射 100L 水，每个方向喷射约 3 分钟。）



固体异物侵入防护等级

完全杜绝灰尘落入对设备造成不良干扰（防尘）。
（将设备在实验室中静置 8 小时，使用搅拌机以 2 千克 / 立方米的速度将滑石粉颗粒的直径搅拌至 $75\mu\text{m}$ 以下，使其漂浮在空中。）

虽然设备已配备了防尘、防水设计，但并不能排除发生故障的可能性。请勿将设备放置在可能会存在大量灰尘、溅到大量水或雨水的环境中。

符号

警告！

如下所示的符号用于本机。使用前请务必理解其含意。

	为降低伤害风险，用户必须阅读使用说明书	n_0	空载转速
	直流电	/min	每分钟的振动次数
V	额定电压		警告

规格

电动工具

型式	WH18DC	
电压	18V	
空载转速	强力模式	0—3400/min
	螺栓模式 / 螺栓单拧模式	0—2900/min
	轻柔模式	0—900/min
	自钻螺钉模式	0—3700/min
能力	小螺钉	M4—M10
	普通螺栓	M5—M18
	高强度抗拉螺栓	M5—M14
	自钻螺钉	$\phi 3.5 - \phi 6$
旋紧扭矩	最大 210N·m	
	在 20°C 的温度下完全充电时， 旋紧 M16 高强度抗拉螺栓 旋紧时间：3 秒	
钎柄尺寸	6.35mm 六角螺栓	
电池	BSL36A18：锂离子 36V / 18V (2.5Ah / 5.0Ah 10 节)	
重量	1.6kg (安装 BSL36A18)	



充电器

型式	UC18YSL3
充电电压	14.4—18 V
重量	0.6kg

标准附件

除了主机（1 台）外，产品包中还包括表中所列的附件。

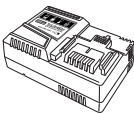
表 1

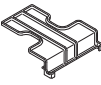
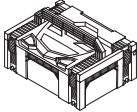
		WH18DC
		NNP
充电器（UC18YSL3）		—
电池（BSL36A18）		—
电池盖		—
塑料盒（可堆叠）		1

根据工具套件的规格不同，所提供的充电器和电池会有所不同。

用途

旋紧和拆除机用螺丝、木螺丝、自攻螺丝等。

电池的拆卸 / 安装法

1. 电池的拆卸法

请先紧抓住把手、然后再推压电池插销以拆下电池（参照图 3 和图 4）。

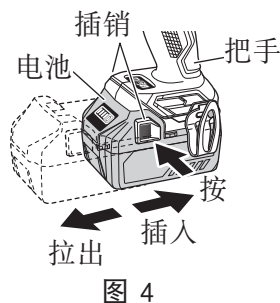

注意！

切勿使电池短路。

2. 电池的安装法

插入电池时请注意极性（参照图 4）。

充电

使用电动工具之前，按下述方法将电池进行充电。

1. 将充电器的电源线连接到插座。

将充电器插头连接到插座时，指示灯闪烁红色（间隔为 1 秒）。

2. 将电池插入充电器。

如图 5 所示，将电池紧紧地插入充电器。

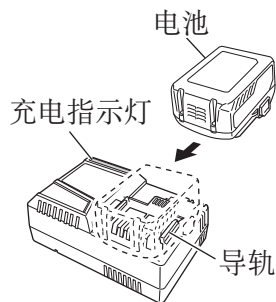

3. 充电

将电池插入充电器后，充电指示灯将呈蓝色闪烁。







电池完全充电后，充电指示灯将持续点亮呈绿色。（参照第 12 页的表 2）

中文

(1) 充电指示灯的指示状态

根据充电器或可充电电池的情况，充电指示灯的显示如 表 2 所示。

表 2

充电指示灯的指示状态				
充电指示灯 (红 / 蓝 / 绿 / 紫)	充电前	闪烁 (红)	点亮 0.5 秒钟。不点亮 0.5 秒钟。(熄灭 0.5 秒钟) 	插入电源
	充电时	闪烁 (蓝)	点亮 0.5 秒钟。不点亮 1 秒 钟。(熄灭 1 秒钟) 	电池电量低于50%
		闪烁 (蓝)	点亮 1 秒钟。不点亮 0.5 秒钟。(熄灭 0.5 秒钟) 	电池电量低于80%
		点亮 (蓝)	连续点亮 	电池电量高于80%
	充电完成	点亮 (绿)	连续点亮  (发出持续蜂鸣声：约 6 秒)	
	过热待机	闪烁 (红)	点亮 0.3 秒钟。不点亮 0.3 秒钟。(熄灭 0.3 秒钟) 	电池过热。无法充 电 (电池冷却后将 开始充电)
	无法充电	闪动 (紫色)	点亮 0.1 秒钟。不点亮 0.1 秒钟。(熄灭 0.1 秒钟)  (发出断续蜂鸣声：约 2 秒)	电池或充电器故障

(2) 可充电电池温度和充电时间相关资料。
温度和充电时间如表 3 所示

表 3

充电器		UC18YSL3					
电池	电池类型	锂离子电池					
	电池可充电温度	0°C – 50°C					
	充电电压	V	14.4		18		
	充电时间 (环境温度 20°C)	分钟	BSL14xx 系列		BSL18xx 系列		多电压系列
			(4 节)	(8 节)	(5 节)	(10 节)	(10 节)
			BSL1415S : 15 BSL1415 : 15 BSL1415X : 15 BSL1420 : 20 BSL1425 : 25 BSL1430C : 30	BSL1430 : 20 BSL1440 : 26 BSL1450 : 32 BSL1460 : 38	BSL1815S : 15 BSL1815 : 15 BSL1815X : 15 BSL1820 : 20 BSL1825 : 25 BSL1830C : 30 BSL1840M : 40 BSL1850C : 32	BSL1830 : 20 BSL1840 : 26 BSL1850 : 32 BSL1860 : 38	BSL36A18 : 32 BSL36B18 : 52
USB	充电电压	V	5				
	充电电流	A	2				

注：

充电时间可能会因环境温度和电源电压而异。

4. 从电源插座拔下充电器的电源线。

5. 握紧充电器并取出电池。

注：

充电后，先将电池从充电器中取出，然后妥善保存。

关于新电池的放电。

新电池内部的化学物质未被激活或电池长时间不使用时，初次或第二次使用时需要将其放电至较低电量。这只是暂时现象，将电池充电2-3次即可恢复为充电所需的正常时间。

较长时间保持电池性能的方法

(1) 在电池电力完全耗尽之前进行充电。

感到电动工具的能力变弱时，请停止使用并给电池充电。若您继续使用电动工具并耗尽电力，电池可能会损坏或其使用寿命缩短。

(2) 避免在高温环境中充电。

使用后可充电电池的温度将迅速升高。若使用后立即对这种电池进行充电，其内部化学物质会劣化，电池使用寿命将缩短。请稍等片刻，待电池冷却后再进行充电。

注意！

- 如果电池长时间放置在阳光直射的地方或者刚刚使用完毕时，电池会变热。如果此时对电池充电，充电器的充电指示灯会点亮 0.3 秒钟，然后熄灭 0.3 秒钟（熄灭 0.3 秒钟）。此时请等待电池冷却后再开始充电。
- 充电指示灯闪动（闪动间隔为 0.2 秒钟）时，请检查充电器的电池连接器内是否有异物并加以清除。如没有异物，则可能是电池或充电器发生了故障。请将其送往当地授权服务中心。
- 因内置的微电脑需要约 3 秒钟才能确认正用 UC18YSL3 充电的电池已被取出，因此请等待 3 秒钟后再重新插入电池继续充电。如果在不到 3 秒内就插入电池，则电池可能充电不正常。

作业之前

1. 准备和检查工作环境

确认工作场所满足使用注意事项中所述的所有条件。

2. 检查电池

确认已紧紧装上电池。如果松弛则电池可能会脱开，并造成事故。

3. 安装钻头

按照下述步骤安装螺丝钻头。（图 6）

(1) 从工具前端拉出导套。

(2) 将钻头插入铁钻内的六角孔。

(3) 放开导套，导套返回到原来位置。

(4) 要取下钻头时，请从工具前端拉出导套。



图 6

注意！

如果导套不返回到原来位置，则说明未正确安装钻头。

使用方法

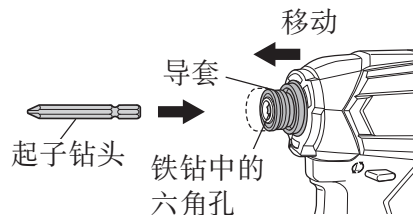
1. 检查旋转方向

推动选择按钮的 R（右）侧，钻头便会顺时针（从后方看时）旋转

按推钮的 L（左）侧使钻头逆时针旋转。（请参照图 7）。（机身上标有(L)和(R)标记。）



图 7

注意！

起子机运转时，无法切换推钮。如需切换推钮，将起子机停止运转后再切换推钮。

2. 开关操作

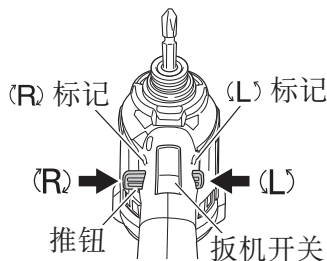
○ 操作时请确保牢牢握住工具。否则可能导致事故或受伤。（图 8）

○ 压下扳机开关，则本机旋转；松开扳机，则本机停止。

○ 可通过改变扳机开关的扣动幅度来控制转速。幅度小则转速低，幅度大则转速高。

○ 松开扳机开关时，制动器将立即停止。

注：

当马达即将起转时，可能会产生一种嗡嗡声。这只不过是一种噪音，而非机器故障。

3. 使用挂钩

挂钩用于在工作时将电动工具挂到腰带上。



图 8

注意！

○ 使用挂钩时，牢固挂好挂钩，以防意外掉落。如果电动工具掉落，可能造成意外伤害。

○ 将电动工具挂在腰带上行动时，切勿在电动工具头上安装任何钻头。如果在将电动工具挂在腰带上行动时安装了尖利的钻头，可能造成伤害。

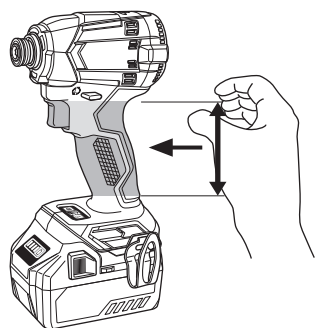
○ 将挂钩安装牢固。如果安装不牢固，在使用时可能造成伤害。

中文

(1) 卸下挂钩。

用十字螺丝刀卸下用于固定挂钩的螺丝。(图 9)

(2) 重新装上挂钩并拧紧螺丝。

将挂钩牢固安装到电动工具的凹槽中，拧紧螺丝固定挂钩。(图 10)



图 9



图 10

4. 剩余电池电量指示灯

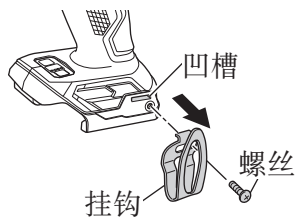
可以按下剩余电池电量指示灯开关点亮指示灯，查看电池的剩余电量。(图 11, 表 4)

按住剩余电池电量指示灯开关约 3 秒后，指示灯将熄灭。

环境温度和电池状态可能会对剩余电池电量产生轻微的影响，因此，建议您仅将指示灯作为参考。

此外，电动工具或充电器上的剩余电池电量指示灯可能有所不同。

剩余电池电量指示灯 剩余电池电量指示灯开关





图 11

表 4

指示灯状态	电池剩余电量
	点亮； 电池剩余电量超过 75%
	点亮； 电池剩余电量为50%—75%
	点亮； 电池剩余电量为25%—50%
	点亮； 电池剩余电量不到 25%

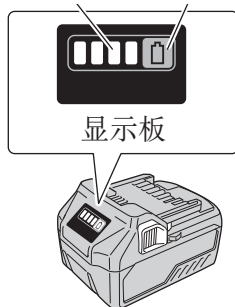
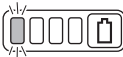
	闪烁； 电池剩余电量即将耗尽。请尽快对电池进行充电。
	闪烁； 因高温暂停输出从电动工具中取下电池，让电池完全冷却。
	闪烁； 因失败或故障暂停输出。电池可能出现故障，请与经销商联系。

环境温度和电池特性不同，则所显示的电池剩余电量也会有些许不同，以上内容仅供参考。

注：

请勿强烈撞击或破坏开关面板。否则可能会导致故障。

5. LED 灯的使用方法

按下灯的开关，LED 灯模式的变化如表 5 所示。

(图 12)

请经常关灯以防消耗电池电量。

表 5

	常亮模式	SW 互锁模式	省电模式
状态	常亮模式 (2 分钟后 关闭)	仅在软件运行时亮灯	常灭



图 12

注意！

- 请不要直视灯光，避免眼睛直接受灯光照射。
如果眼睛持续受灯光照射，会伤害眼睛。
- 用软布仔细擦拭附着在 LED 灯镜片上的灰尘或污垢，小心不要划伤镜片。
如果划伤 LED 灯的镜片，可能会导致亮度减弱。

注：

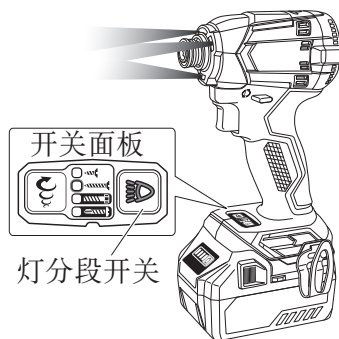
如果忘记关闭 LED 灯，LED 灯将自动熄灭 2 分钟以防消耗电池电量。

6. 旋紧模式选择功能

注意！

- 请勿撞击或损坏开关面板。
- 请在松开扳机开关时选择旋紧模式。否则可能导致故障。

(1) 旋紧模式选择开关

通过使用旋紧模式选择开关，可以根据作业类型调整旋紧扭矩。

每按一次旋紧模式旋转开关，即可在 5 种不同的模式中切换旋紧模式。

在螺栓单拧模式下拉动扳机开关时，起子机将在施加多个冲击力后自动停止。轻柔 / 强力 / 螺栓和自钻螺钉模式在拉动扳机开关时开始冲击，并持续冲击而不会自动停止。

轻柔模式是一种不会损坏薄钉或装饰材料的模式。

强力模式可用于正常作业至重负荷作业。

由于螺栓模式下的扳机开关拉动限度短，因此该模式下的起子机非常适合于高速旋紧作业。

螺栓单拧模式通过控制冲击力来控制旋紧力。该模式用于旋紧诸如机架、栅栏、家具等的螺栓之类的精细作业。

自钻螺钉模式是旋紧自钻螺钉的理想选择，该模式可降低由于过度旋紧而导致螺钉头部断裂、螺钉破损或滑丝的可能性。

旋紧模式选择开关



旋紧模式指示灯









图 13

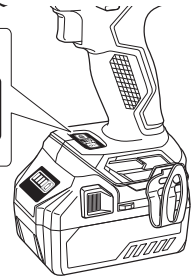
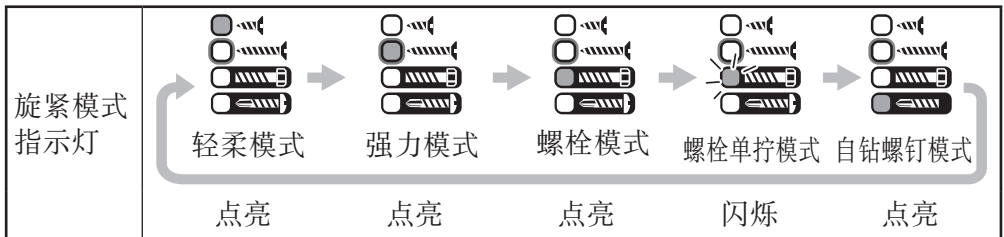

- 注：
- 请根据螺钉和需钻钉的材料选择适当的模式。请钻入一些测试用螺钉，相应地调整模式设定。
 - 仅在驱动器已安装电池且已拉动过一次扳机开关后，才可以对旋紧模式选择开关进行设定。

选择模式旋转开关设定示例

	轻柔模式	强力模式	螺栓模式	螺栓单拧模式	自钻螺钉模式
					
转速	0—900/min	3400/min	0—2900/min		3700/min
使用	“精细作业” 旋紧小直径螺钉 (M6 或类似) 等	“正常作业” 旋紧短螺钉 固定石膏板等 “重负荷作业” 旋紧长螺钉、 方头螺钉、 螺栓等	“旋紧和松开 螺母和螺栓”	“精细作业” 用于机架、 栅栏、家具 等的螺栓	旋紧自钻螺钉

7. 拧紧和拧松螺丝

安装适合螺丝的转头，使转头对准螺丝头的凹槽，然后拧紧螺丝。

推动冲击起子机，使转头恰好与螺丝头吻合。

注意！

- 长时间将冲击起子机应用于螺丝会造成螺丝拧得过紧，且容易使螺丝折断。
- 用冲击起子机拧紧螺丝时，如果起子机与螺丝有一定角度，则可能损坏螺丝头，正确的作用力无法传送到螺丝。拧紧时，使冲击起子机正好对准螺丝。

8. 拧紧和拧松螺栓

首先必须选择与螺栓或螺母相对应的六角扳手。接下来，将套筒安装到铁钻上，用六角扳手咬住要拧紧的螺母。与螺栓成直线地握住工具，按电源开关冲击螺母几秒钟。

如果螺母松动地安装到螺栓上，螺栓可能随着螺母转动，则说明未正确拧紧。在此情况下，停止冲击螺母，用扳手按住螺母头后重新启动冲击，或者手动拧紧螺栓和螺母，以防它们滑动。

9. LED 灯警示信号 (图 14)

该产品设计出具有保护该工具以及电池的功能。当拔出开关，如果在操作过程中触发了任何保护功能，LED 灯将会如第 20 页的表 6 所描述的进行闪光。当触发了任何保护功能，立即将您的手指从开关上移开并按照正确步骤所描述的指引进行操作。





图 14

表 6

保护功能	LED 灯显示	正确步骤
温度保护	开启 0.3 秒 / 关闭 0.3 秒 	让该工具和电池得到充分冷却。

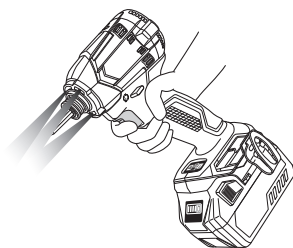
操作上的注意事项

1. 连续作业后须让电动工具休息片刻

在连续进行螺栓紧固作业后以及在更换电池后，请让电动工具暂停作业 15 分钟。如果在更换电池后立刻开始作业，马达和开关等的温度将会升高，结果导致烧毁。

注：

请勿触摸金属部件，它们在连续工作后可能高温。

2. 关于转速控制开关的注意事项

此开关带有可无级改变转速的内置电路。因此，当轻拉启动扳机开关（低速转动）并在连续旋紧螺丝中停止马达转动时，电路部分的元件可能会因过热而损坏。

3. 使用适宜於螺丝的旋紧时间

根据螺丝的材料和尺寸以及所旋紧的材料等，其适宜的转矩有所不同，因此请使用适宜于该螺丝的旋紧时间。尤其是，如果对小于 M8 的螺丝使用过长的旋紧时间，则螺丝有损坏的危险。因此，请事先确认旋紧时间和旋紧转矩。

4. 以适于受冲击螺栓的旋紧扭矩进行操作

螺栓和螺母最适宜的旋紧扭矩因螺栓或螺母的材料和尺寸而有所不同。对小螺栓使用过大的旋紧扭矩会扭曲或损坏螺栓。旋紧扭矩的增加与操作时间成正比。请使用正确的螺栓操作时间。

5. 握住工具

用双手牢牢握住工具。在这种情况下，与螺丝或螺栓成直线地握住工具。无需用力推工具，用足以抵消冲击力的力握住工具。

6. 确定旋紧扭矩

下列因素会造成旋紧扭矩的下降。因此请在工作前用手工扭矩扳手来确定上紧螺栓所需的实际旋紧扭矩。影响旋紧扭矩的因素如下。

(1) 电压

达到放电极限时，电压降低，旋紧扭矩也减少。

(2) 操作时间

操作时间增加时旋紧扭矩也增加。但是，即使工具驱动很长的一段时间，旋紧扭矩也不会增大到超过某个特定值。

(3) 螺栓的直径

旋紧扭矩根据螺栓的直径变化。一般来说较大直径的螺栓需要较大的旋紧扭矩。

(4) 旋紧的状态

即使使用相同尺寸螺纹的螺栓，旋紧扭矩根据螺栓的扭矩比率、等级和长度也各不相同。旋紧扭矩还因螺栓所要上紧的加工件的表面状况而有所不同。螺栓和螺母一起转动时，扭矩会大大减少。

(5) 拧紧扭矩因电池充电程度而异。

USB设备的充电方法

警告

- 使用之前请检查 USB 连接线缆是否有破损或损坏。
使用有破损或损坏的 USB 线缆可能会导致冒烟或着火。
- 不使用产品时，请用橡胶盖封好 USB 端口。
USB 端口中落入灰尘等可能会导致冒烟或着火。

注：

- USB 充电过程中，可能会有偶尔暂停。
- USB 设备未充电时，请将充电器上拔下 USB 设备。
否则不仅会减少 USB 设备的电池寿命，还会导致意外事故。
- 根据设备类型，可能无法对部分 USB 设备进行充电。

(1) 选择充电方式

根据所选的充电方式，将电池插入充电器或连接电源线插入插座。

- 将 USB 设备插入插座进行充电（图 15-a）。
- 将 USB 设备和电池插入插座进行充电。（图 15-b）



图 15

中文

(2) 连接 USB 线缆。(图 16)

拔下橡胶盖并将市售的 USB 线缆（匹配充电的设备）紧紧插入 USB 端口。

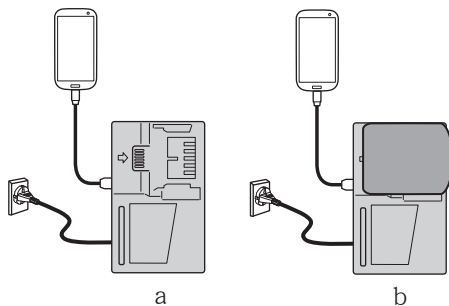

图 16

(3) 充电完成时

- 检查 USB 设备以检验充电状态。
- 从插座中拔下电源线。(图 17)
- 用橡胶盖盖住 USB 端口。

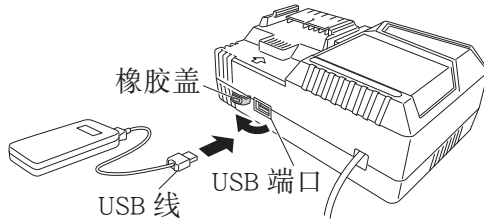

图 17

维护和检查

1. 检查工具

继续使用已破损的钻头或钻头尖已磨损的钻头是非常危险的，因为钻头会滑脱。因此，请更换已破损的钻头或钻头尖已磨损的钻头。

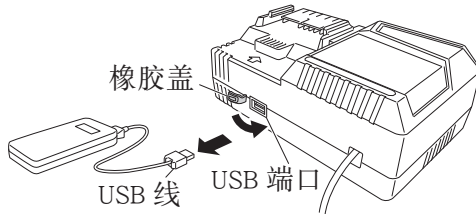
2. 检查安装螺钉

要经常检查安装螺钉是否紧固妥善。若发现螺钉松了，应立即重新扭紧，否则会导致严重的事故。

3. 电动机的维护

电动机绕线是电动工具的“心脏部”应仔细检查有无损伤，是否被油液或水沾湿。

4. 检查端子（工具和电池）

确保端子上没有堆积削屑和灰尘。

在操作前、操作时和操作后需要时常检查。

注意！

请清除端子上的削屑或灰尘。

否则可能导致故障。

5. 清理外部

冲击起子机沾污时，用干软布或沾肥皂水的布擦拭。切勿使用氯溶液、汽油或稀释剂，以免塑胶部分溶化。

6. 收藏

冲击起子机和电池应收藏于温度低于 40°C 和小孩拿不到的地方。

注：

存放锂离子电池

在存放前请确保电池已完全充电。

电池在低电量的状态下长时间存放（3 个月或更长），可能会导致电池性能劣化，使用时间明显减少或无法进行充电。

但是，即使是使用时间明显减少的电池，通过反复充电和使用 2 ~ 5 次，有时也可恢复使用时间。

若反复充电和使用后电池的使用时间仍非常短，请认作为电池已达到了使用寿命并更换新的电池。

注意！

在操作和维修电动工具时，必须遵守贵国制定的安全的有关规则和标准。

关于 HiKOKI 牌无线电动工具的重要通知：

请确保始终使用我们指定的正版电池。如果使用我们指定以外的电池，或对电池进行拆卸和改动（例如拆卸和更换电池组件或其他内部部件），那么我们无法保证我们无线电动工具的安全性和使用性能。

故障排除

如果工具操作不正常，请使用下表中的检查步骤。如果未能解决问题，请向经销商或 HiKOKI 公司授权服务中心咨询。

1. 电动工具

现象	可能的原因	解决办法
工具无法运行	没有剩余电池电量	为电池充电
	插入电池时，扳机开关为按下状态。	安全功能被激活。 一旦松开扳机开关，然后重新拉动，工具将开始运转。
工具突然停止	工具过度负重	避免因负载过重而引发的问题。
	电池过热。	让电池冷却。
	按下扳机开关 5 分钟或更久。	这种情况不属于故障。 电机已自动停止以防止工具发生故障。

现象	可能的原因	解决办法
钻头 - 无法安装 - 掉落	安装部分的形状不匹配	请使用开口尺寸宽 6.35 mm 的六角柄进行操作。
		如果使用 L 型工具钻头，请替换为 S 型钻头。
无法拔出开关	向前 / 向后选择按钮没有按到底	根据想要的旋转方向将按钮紧压到底
拉动扳机开关时，将发出异常尖锐的噪声。	请轻微拉动扳机开关。	这种情况不属于故障。如果充分拉动扳机开关，则不会发生此种情况。
螺丝头滑落或松开	钻头数量与螺丝尺寸不匹配	安装适合的钻头
	钻头已经磨损	替换为新钻头

2. 充电器

现象	可能的原因	解决办法
充电指示灯快速闪烁紫色，电池未开始充电。	电池未完全插入。	请紧紧插入电池。
	电池端部或电池的连接处有异物。	将异物清除。
充电指示灯闪烁红色，电池未开始充电。	电池未完全插入。	请紧紧插入电池。
	电池过热。	如果继续放置，电池将在温度降低后自动开始充电，但此种情况可能会缩短电池使用寿命。建议将电池放置在通风良好的位置，在充电前避免阳光直射。
即使电池完全充电，电池的使用寿命也会逐渐缩短。	电池的使用寿命已耗尽。	请更换新电池。
电池的充电时间较长。	电池、充电器或周围环境的温度过低。	请在室内或温暖的环境中充电。
	充电器的排气孔堵塞，导致其内部部件过热。	请勿堵塞排气孔。
	冷却扇未运转。	请联系 HiKOKI 授权服务中心进行维修。

现象	可能的原因	解决办法
USB 电源灯熄灭，USB 设备停止充电。	电池剩余电量低。	用电量充足电池替换它。
		将充电器的电源插头插入电插座中。
即使 USB 设备充电完毕，USB 电源灯也不熄灭。	USB 电源灯点亮呈绿色，提示可进行 USB 充电。	这种情况不属于故障。
不清楚 USB 设备的充电状态如何或者是否充电完毕。	即使充电完毕，USB 电源灯也不熄灭。	检查正在充电的 USB 设备以确定其充电状态。
USB 设备在中途暂停充电。	使用电池作为电源对 USB 设备进行充电时，充电器插入电插座。	这种情况不属于故障。充电器与电源间存在差异时，USB 将暂停充电约 5 秒钟。
	使用电源插座作为电源对 USB 设备进行充电时，电池插入充电器。	
电池和 USB 设备同时充电时，USB 设备将在中途暂停充电。	电池已完全充电。	这种情况不属于故障。检查电池是否已充电完成时，充电器将暂停 USB 充电约 5 秒钟。
电池和 USB 设备同时充电时，USB 设备将无法开始充电。	电池剩余电量已不足。	这种情况不属于故障。电池电量达到一定程度时，USB 将自动开始充电。

选择附件

根据特定作业选择适合的附件。
有关详细信息请联系 HiKOKI 授权服务中心。

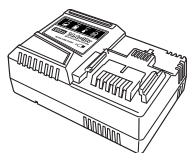

UC18YSL3
(14.4V-18V)
充电器



BSL36A18
电池

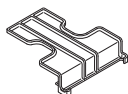

产品编号：329897
电池盖

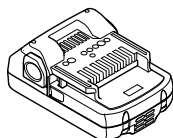

BSL18..

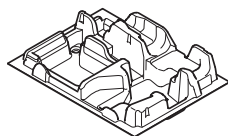
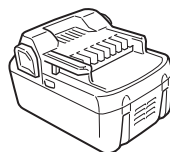

产品编号：339776

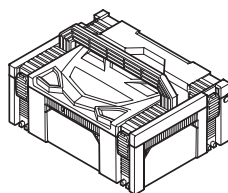

产品编号：336471
塑料盒（可堆叠）



浅金色：产品编号：377857
钛银色：产品编号：377858
天蓝色：产品编号：377859
蓝紫色：产品编号：377860
信号红：产品编号：377861
色板

CONTENTS

GENERAL POWER TOOL SAFETY WARNINGS	27
CORDLESS IMPACT DRIVER SAFETY WARNINGS	30
CAUTION ON LITHIUM-ION BATTERY	31
REGARDING LITHIUM-ION BATTERY TRANSPORTATION	33
USB DEVICE CONNECTION PRECAUTIONS	33
PRECAUTIONS REGARDING THE DUST-RESISTANCE AND WATER-PROOFING FUNCTIONS.....	34
SYMBOLS	34
SPECIFICATIONS	35
STANDARD ACCESSORIES	36
APPLICATIONS.....	36
BATTERY REMOVAL / INSTALLATION	37
CHARGING	37
PRIOR TO OPERATION.....	40
HOW TO USE.....	41
OPERATIONAL CAUTIONS.....	46
HOW TO RECHARGE USB DEVICE	47
MAINTENANCE AND INSPECTION	49
TROUBLESHOOTING.....	50
SELECTING ACCESSORIES.....	53

GENERAL POWER TOOL SAFETY WARNINGS

WARNING

Read all safety warnings, instructions, illustrations and specifications provided with this power tool.

Failure to follow all instructions listed below may result in electric shock, fire and/or serious injury.

Save all warnings and instructions for future reference.

The term “power tool” in the warnings refers to your mains-operated (corded) power tool or battery-operated (cordless) power tool.

- 1) **Work area safety**
 - a) **Keep work area clean and well lit.**
Cluttered or dark areas invite accidents.
 - b) **Do not operate power tools in explosive atmospheres, such as in the presence of flammable liquids, gases or dust.**
Power tools create sparks which may ignite the dust or fumes.
 - c) **Keep children and bystanders away while operating a power tool.**
Distractions can cause you to lose control.

English

2) Electrical safety

- a) **Power tool plugs must match the outlet.**
Never modify the plug in any way.
Do not use any adapter plugs with earthed (grounded) power tools.
Unmodified plugs and matching outlets will reduce risk of electric shock.
- b) **Avoid body contact with earthed or grounded surfaces, such as pipes, radiators, ranges and refrigerators.**
There is an increased risk of electric shock if your body is earthed or grounded.
- c) **Do not expose power tools to rain or wet conditions.**
Water entering a power tool will increase the risk of electric shock.
- d) **Do not abuse the cord. Never use the cord for carrying, pulling or unplugging the power tool.**
Keep cord away from heat, oil, sharp edges or moving parts.
Damaged or entangled cords increase the risk of electric shock.
- e) **When operating a power tool outdoors, use an extension cord suitable for outdoor use.**
Use of a cord suitable for outdoor use reduces the risk of electric shock.
- f) **If operating a power tool in a damp location is unavoidable, use a residual current device (RCD) protected supply.**
Use of an RCD reduces the risk of electric shock.

3) Personal safety

- a) **Stay alert, watch what you are doing and use common sense when operating a power tool.**
Do not use a power tool while you are tired or under the influence of drugs, alcohol or medication.
A moment of inattention while operating power tools may result in serious personal injury.
- b) **Use personal protective equipment. Always wear eye protection.**
Protective equipment such as a dust mask, non-skid safety shoes, hard hat or hearing protection used for appropriate conditions will reduce personal injuries.
- c) **Prevent unintentional starting. Ensure the switch is in the off-position before connecting to power source and/or battery pack, picking up or carrying the tool.**
Carrying power tools with your finger on the switch or energising power tools that have the switch on invites accidents.
- d) **Remove any adjusting key or wrench before turning the power tool on.**
A wrench or a key left attached to a rotating part of the power tool may result in personal injury.
- e) **Do not overreach. Keep proper footing and balance at all times.**
This enables better control of the power tool in unexpected situations.
- f) **Dress properly. Do not wear loose clothing or jewellery. Keep your hair, clothing and gloves away from moving parts.**
Loose clothes, jewellery or long hair can be caught in moving parts.

- g) **If devices are provided for the connection of dust extraction and collection facilities, ensure these are connected and properly used.**
Use of dust collection can reduce dust-related hazards.
- h) **Do not let familiarity gained from frequent use of tools allow you to become complacent and ignore tool safety principles.**
A careless action can cause severe injury within a fraction of a second.

4) Power tool use and care

- a) **Do not force the power tool. Use the correct power tool for your application.**
The correct power tool will do the job better and safer at the rate for which it was designed.
- b) **Do not use the power tool if the switch does not turn it on and off.**
Any power tool that cannot be controlled with the switch is dangerous and must be repaired.
- c) **Disconnect the plug from the power source and/or remove the battery pack, if detachable, from the power tool before making any adjustments, changing accessories, or storing power tools.**
Such preventive safety measures reduce the risk of starting the power tool accidentally.
- d) **Store idle power tools out of the reach of children and do not allow persons unfamiliar with the power tool or these instructions to operate the power tool.**
Power tools are dangerous in the hands of untrained users.
- e) **Maintain power tools and accessories. Check for misalignment or binding of moving parts, breakage of parts and any other condition that may affect the power tool's operation.**
If damaged, have the power tool repaired before use.
Many accidents are caused by poorly maintained power tools.
- f) **Keep cutting tools sharp and clean.**
Properly maintained cutting tools with sharp cutting edges are less likely to bind and are easier to control.
- g) **Use the power tool, accessories and tool bits etc. in accordance with these instructions, taking into account the working conditions and the work to be performed.**
Use of the power tool for operations different from those intended could result in a hazardous situation.
- h) **Keep handles and grasping surfaces dry, clean and free from oil and grease.**
Slippery handles and grasping surfaces do not allow for safe handling and control of the tool in unexpected situations.

5) Battery tool use and care

- a) **Recharge only with the charger specified by the manufacturer.**
A charger that is suitable for one type of battery pack may create a risk of fire when used with another battery pack.
- b) **Use power tools only with specifically designated battery packs.**
Use of any other battery packs may create a risk of injury and fire.

English

- c) **When battery pack is not in use, keep it away from other metal objects, like paper clips, coins, keys, nails, screws or other small metal objects, that can make a connection from one terminal to another.**
Shorting the battery terminals together may cause burns or a fire.
- d) **Under abusive conditions, liquid may be ejected from the battery; avoid contact. If contact accidentally occurs, flush with water. If liquid contacts eyes, additionally seek medical help.**
Liquid ejected from the battery may cause irritation or burns.
- e) **Do not use a battery pack or tool that is damaged or modified.**
Damaged or modified batteries may exhibit unpredictable behaviour resulting in fire, explosion or risk of injury.
- f) **Do not expose a battery pack or tool to fire or excessive temperature.**
Exposure to fire or temperature above 130°C may cause explosion.
- g) **Follow all charging instructions and do not charge the battery pack or tool outside the temperature range specified in the instructions.**
Charging improperly or at temperatures outside the specified range may damage the battery and increase the risk of fire.

6) Service

- a) **Have your power tool serviced by a qualified repair person using only identical replacement parts.**
This will ensure that the safety of the power tool is maintained.
- b) **Never service damaged battery packs.**
Service of battery packs should only be performed by the manufacturer or authorized service providers.

CAUTION

Keep children and infirm persons away.

When not in use, tools should be stored out of reach of children and infirm persons.

CORDLESS IMPACT DRIVER SAFETY WARNINGS

1. **Hold power tool by insulated gripping surfaces, when performing an operation where the fastener may contact hidden wiring. Fasteners contacting a “live” wire may make exposed metal parts of the power tool “live” and could give the operator an electric shock.**
2. **This is portable tool for tightening and loosening screws. Use it only for these operation.**
3. **Use the earplugs if using for a long time.**
4. **One-hand operation is extremely dangerous; hold the unit firmly with both hands when operating.**
5. **After installing the driver bit, pull lightly out the bit to make sure that it does not come loose. If the bit is not installed properly, it can come loose during use, which can be dangerous.**

6. Use the bit that matches the screw.
7. Tightening a screw with the impact driver at an angle to that screw can damage the head of the screw and the proper force will not be transmitted to the screw. Tighten with this impact driver lined up straight with the screw.
8. Always charge the battery at a temperature of 0–40°C.
A temperature of less than 0°C will result in over charging which is dangerous. The battery cannot be charged at a temperature greater than 40°C.
The most suitable temperature for charging is that of 20–25°C.
9. Do not use the charger continuously.
When one charging is completed, leave the charger for about 15 minutes before the next charging of battery.
10. Do not allow foreign matter to enter the hole for connecting the battery.
11. Never disassemble the battery and charger.
12. Never short-circuit the battery.
Short-circuiting the battery will cause a great electric current and overheat. It results in burn or damage to the battery.
13. Do not dispose of the battery in fire.
If the battery burnt, it may explode.
14. Do not insert object into the air ventilation slots of the charger.
Inserting metal objects or inflammables into the charger air ventilation slots will result in electrical shock hazard or damaged charger.
15. Bring the battery to the shop from which it was purchased as soon as the post-charging battery life becomes too short for practical use. Do not dispose of the exhausted battery.
16. Using an exhausted battery will damage the charger.
17. Do not use the product if the tool or the battery terminals (battery mount) are deformed.
Installing the battery could cause a short circuit that could result in smoke emission or ignition.
18. Keep the tool's terminals (battery mount) free of swarf and dust.
 - Prior to use, make sure that swarf and dust have not collected in the area of the terminals.
 - During use, try to avoid swarf or dust on the tool from falling on the battery.
 - When suspending operation or after use, do not leave the tool in an area where it may be exposed to falling swarf or dust.
Doing so could cause a short circuit that could result in smoke emission or ignition.

CAUTION ON LITHIUM-ION BATTERY

To extend the lifetime, the lithium-ion battery equips with the protection function to stop the output.

In the cases of 1 to 3 described below, when using this product, even if you are pulling the switch, the motor may stop. This is not the trouble but the result of protection function.

English

1. When the battery power remaining runs out, the motor stops.
In such case, charge it up immediately.
2. If the tool is overloaded, the motor may stop. In this case, release the switch of tool and eliminate causes of overloading. After that, you can use it again.
3. If the battery is overheated under overload work, the battery power may stop.
In this case, stop using the battery and let the battery cool. After that, you can use it again.

Furthermore, please heed the following warning and caution.

WARNING

In order to prevent any battery leakage, heat generation, smoke emission, explosion and ignition beforehand, please be sure to heed the following precautions.

1. Make sure that swarf and dust do not collect on the battery.
 - During work make sure that swarf and dust do not fall on the battery.
 - Make sure that any swarf and dust falling on the power tool during work do not collect on the battery.
 - Do not store an unused battery in a location exposed to swarf and dust.
 - Before storing a battery, remove any swarf and dust that may adhere to it and do not store it together with metal parts (screws, nails, etc.).
2. Do not pierce battery with a sharp object such as a nail, strike with a hammer, step on, throw or subject the battery to severe physical shock.
3. Do not use an apparently damaged or deformed battery.
4. Do not use the battery in reverse polarity.
5. Do not connect directly to an electrical outlets or car cigarette lighter sockets.
6. Do not use the battery for a purpose other than those specified.
7. If the battery charging fails to complete even when a specified recharging time has elapsed, immediately stop further recharging.
8. Do not put or subject the battery to high temperatures or high pressure such as into a microwave oven, dryer, or high pressure container.
9. Keep away from fire immediately when leakage or foul odor are detected.
10. Do not use in a location where strong static electricity generates.
11. If there is battery leakage, foul odor, heat generated, discolored or deformed, or in any way appears abnormal during use, recharging or storage, immediately remove it from the equipment or battery charger, and stop use.
12. Do not immerse the battery or allow any fluids to flow inside. Conductive liquid ingress, such as water, can cause damage resulting in fire or explosion. Store your battery in a cool, dry place, away from combustible and flammable items. Corrosive gas atmospheres must be avoided.

CAUTION

1. If liquid leaking from the battery gets into your eyes, do not rub your eyes and wash them well with fresh clean water such as tap water and contact a doctor immediately.
If left untreated, the liquid may cause eye-problems.

2. If liquid leaks onto your skin or clothes, wash well with clean water such as tap water immediately.
There is a possibility that this can cause skin irritation.
3. If you find rust, foul odor, overheating, discolor, deformation, and/or other irregularities when using the battery for the first time, do not use or return it to your supplier or vendor.

WARNING

If a conductive foreign matter enters in the terminal of lithium ion battery, the battery may be shorted, causing fire. When storing the lithium ion battery, obey surely the rules of following contents.

- Do not place conductive debris, nail and wires such as iron wire and copper wire in the storage case.
- Either install the battery in the power tool or store by securely pressing into the battery cover until the ventilation holes are concealed to prevent short-circuits (See Fig. 1).

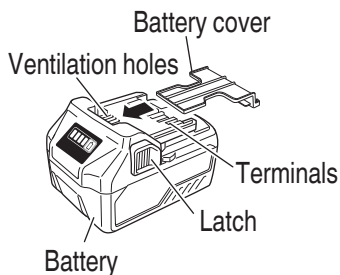

Fig. 1

REGARDING LITHIUM-ION BATTERY TRANSPORTATION

When transporting a lithium-ion battery, please observe the following precautions.

WARNING

Notify the transporting company that a package contains a lithium-ion battery, inform the company of its power output and follow the instructions of the transportation company when arranging transport.

- Lithium-ion batteries that exceed a power output of 100 Wh are considered to be in the freight classification of Dangerous Goods and will require special application procedures.
- For transportation abroad, you must comply with international law and the rules and regulations of the destination country.

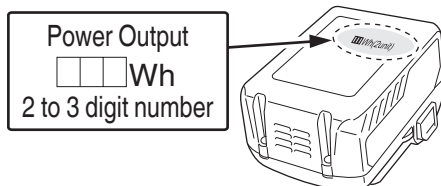

Fig. 2

USB DEVICE CONNECTION PRECAUTIONS

When an unexpected problem occurs, the data in a USB device connected to this product may be corrupted or lost. Always make sure to back up any data contained in the USB device prior to use with this product.

Please be aware that our company accepts absolutely no responsibility for any data stored in a USB device that is corrupted or lost, nor for any damage that may occur to a connected device.

PRECAUTIONS REGARDING THE DUST-RESISTANCE AND WATER-PROOFING FUNCTIONS

This product conforms to IP56 protection class ratings (dust-resistance and water-proofing) for electrical equipment as stipulated by the international IEC regulations. (Only the main unit conforms to the IP56 protection class ratings when equipped with a battery.)

[Descriptions of IP Codes]

IP56



- ↳ Protection rating for water penetration
Must be no adverse effects on the equipment when sprayed with powerful jets of water from all directions (water-proofed).
(100 L of water per minute sprayed for approximately three minutes from a distance of approximately three meters with the use of a spray nozzle with a diameter of 12.5 mm.)
- ↳ Protection rating for external assault by solid objects
Dust that may cause adverse effects on the equipment must not be able to enter (dust-resistance).
(The equipment to be left non-operable in a test chamber in which particles of talcum powder with a diameter of less than 75 μm are floating in the air with the use of an agitation pump at a rate of 2 kg per cubic meter for eight hours.)

The equipment has been designed to withstand the effects of dust and water, but there is no guarantee that it will not malfunction. Do not use or leave the equipment in locations where it is subject to excessive amounts of dust, or in locations where it is submerged in water or subject to rainwater.

SYMBOLS

WARNING

The following show symbols used for the machine. Be sure that you understand their meaning before use.

	To reduce the risk of injury, user must read instruction manual.	n_0	No-load speed
	Direct current	/min	Oscillation per minute
V	Rated voltage		Warning

SPECIFICATIONS

POWER TOOL

Model		WH18DC
Voltage		18 V
No-load speed	Power mode	0–3400 /min
	Bolt mode/Bolt single mode	0–2900 /min
	Soft mode	0–900 /min
	Self drilling screw mode	0–3700 /min
Capacity	Small screw	M4–M10
	Ordinary bolt	M5–M18
	High tension bolt	M5–M14
	Self drilling screw	φ3.5–φ6
Tightening torque		Maximum 210 N·m
		Tightening is M16 high tension bolt, when fully charged at 20°Ctemp. Tightening time: 3 sec.
Bit shank size		6.35 mm Hex.
Battery		BSL36A18: Li-ion 36 V / 18 V (2.5 Ah / 5.0 Ah 10 cells)
Weight		1.6 kg (BSL36A18 attached)



CHARGER

Model	UC18YSL3
Charging voltage	14.4–18 V
Weight	0.6 kg

STANDARD ACCESSORIES

In addition to the main unit (1 unit), the package contains the accessories listed in the below.

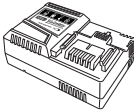
Table 1

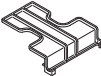
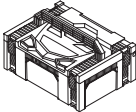
		WH18DC
		NNP
Charger (UC18YSL3)		—
Battery (BSL36A18)		—
Battery cover		—
Plastic case (Stackable)		1

The charger and battery supplied are different depending on the set specification.

APPLICATIONS

Driving and removing of machine screws, wood screws, tapping screws, etc.

BATTERY REMOVAL / INSTALLATION

1. Battery removal
Hold the handle tightly and push the battery latches to remove the battery (see **Fig. 3, 4**).

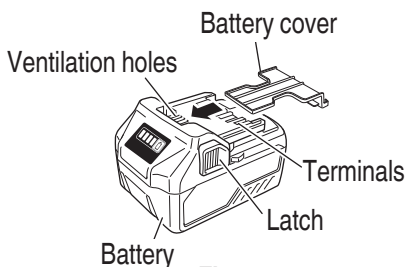

Fig. 3

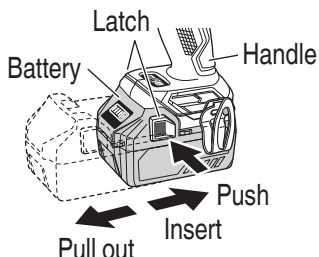

Fig. 4

CAUTION

Never short-circuit the battery.

2. Battery installation
Insert the battery while observing its polarities (see **Fig. 4**).

CHARGING

Before using the power tool, charge the battery as follows.

1. **Connect the charger's power cord to the receptacle.**

When connecting the plug of the charger to a receptacle, the pilot lamp will blink in red (At 1- second intervals).

2. **Insert the battery into the charger.**

Firmly insert the battery into the charger as shown in **Fig. 5**.

3. **Charging**

When inserting a battery in the charger, the charge indicator lamp will blink in blue.

When the battery becomes fully recharged, the charge indicator lamp will light up in green. (See **Table 2 on page 38**)

- (1) Charge indicator lamp indication

The indications of the charge indicator lamp will be as shown in **Table 2 on page 38**, according to the condition of the charger or the rechargeable battery.

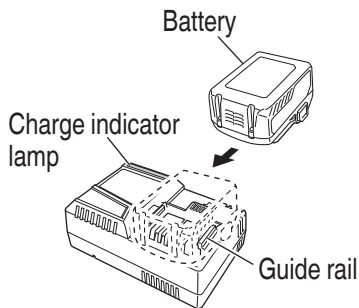





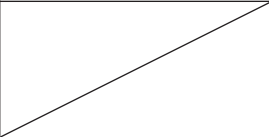



Fig. 5

Table 2

Indications of the charge indicator lamp				
Charge indicator lamp (RED / BLUE / GREEN / PURPLE)	Before charging	Blinks (RED)	Lights for 0.5 seconds. Does not light for 0.5 seconds. (off for 0.5 seconds) 	Plugged into power source
	While charging	Blinks (BLUE)	Lights for 0.5 seconds. Does not light for 1 second. (off for 1 second) 	Battery capacity at less than 50%
		Blinks (BLUE)	Lights for 1 second. Does not light for 0.5 seconds. (off for 0.5 seconds) 	Battery capacity at less than 80%
		Lights (BLUE)	Lights continuously 	Battery capacity at more than 80%
	Charging complete	Lights (GREEN)	Lights continuously  (Continuous buzzer sound: about 6 seconds)	
	Overheat standby	Blinks (RED)	Lights for 0.3 seconds. Does not light for 0.3 seconds. (off for 0.3 seconds) 	Battery overheated. Unable to charge. (Charging will commence when battery cools)
	Charging impossible	Flickers (PURPLE)	Lights for 0.1 seconds. Does not light for 0.1 seconds. (off for 0.1 seconds)  (Intermittent buzzer sound: about 2 seconds)	Malfunction in the battery or the charger

- (2) Regarding the temperatures and charging time of the rechargeable battery
The temperatures and charging time will become as shown in **Table 3**.

Table 3

Charger		UC18YSL3					
Battery	Type of battery	Li-ion					
	Temperatures at which the battery can be recharged	0°C-50°C					
	Charging voltage	V	14.4		18		
	Charging time, approx. (At 20°C)	min	BSL14xx series		BSL18xx series		Multi volt series
			(4 cells)	(8 cells)	(5 cells)	(10 cells)	(10 cells)
		BSL1415S: 15 BSL1415 : 15 BSL1415X: 15 BSL1420 : 20 BSL1425 : 25 BSL1430C: 30	BSL1430 : 20 BSL1440 : 26 BSL1450 : 32 BSL1460 : 38	BSL1815S: 15 BSL1815 : 15 BSL1815X: 15 BSL1820 : 20 BSL1825 : 25 BSL1830C: 30 BSL1840M: 40 BSL1850C: 32	BSL1830 : 20 BSL1840 : 26 BSL1850 : 32 BSL1860 : 38	BSL36A18: 32 BSL36B18: 52	
USB	Charging voltage	V	5				
	Charging current	A	2				

NOTE

The recharging time may vary according to the ambient temperature and power source voltage.

4. Disconnect the charger's power cord from the receptacle.**5. Hold the charger firmly and pull out the battery.****NOTE**

Be sure to pull out the battery from the charger after use, and then keep it.

Regarding electric discharge in case of new batteries, etc.

As the internal chemical substance of new batteries and batteries that have not been used for an extended period is not activated, the electric discharge might be low when using them the first and second time. This is a temporary phenomenon, and normal time required for recharging will be restored by recharging the batteries 2-3 times.

English

How to make the batteries perform longer.

- (1) Recharge the batteries before they become completely exhausted.
When you feel that the power of the tool becomes weaker, stop using the tool and recharge its battery. If you continue to use the tool and exhaust the electric current, the battery may be damaged and its life will become shorter.
- (2) Avoid recharging at high temperatures.
A rechargeable battery will be hot immediately after use. If such a battery is recharged immediately after use, its internal chemical substance will deteriorate, and the battery life will be shortened. Leave the battery and recharge it after it has cooled for a while.

CAUTION

- **If the battery is charged while it is heated because it has been left for a long time in a location subject to direct sunlight or because the battery has just been used, the charge indicator lamp of the charger lights for 0.3 seconds, does not light for 0.3 seconds (off for 0.3 seconds). In such a case, first let the battery cool, then start charging.**
- **When the charge indicator lamp flickers (at 0.2-second intervals), check for and take out any foreign objects in the charger's battery connector. If there are no foreign objects, it is probable that the battery or charger is malfunctioning. Take it to your authorized Service Center.**
- **Since the built-in micro computer takes about 3 seconds to confirm that the battery being charged with UC18YSL3 is taken out, wait for a minimum of 3 seconds before reinserting it to continue charging. If the battery is reinserted within 3 seconds, the battery may not be properly charged.**

PRIOR TO OPERATION

1. Preparing and checking the work environment
Make sure that the work site meets all the conditions laid forth in the precautions.
2. Checking the battery
Make sure that the battery is installed firmly. If it is at all loose it could come off and cause an accident.
3. Installing the bit
Always follow the following procedure to install driver bit. (**Fig. 6**)
 - (1) Pull the guide sleeve away from front of the tool.
 - (2) Insert the bit into the hexagonal hole in the anvil.
 - (3) Release the guide sleeve and it returns to its original position.
 - (4) If you want to remove the bit, pull the guide sleeve away from front of the tool.

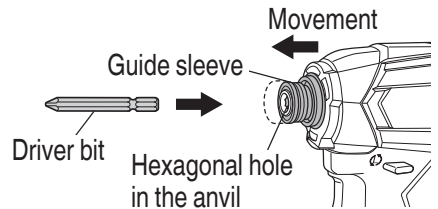

Fig. 6

CAUTION

If the guide sleeve does not return to its original position, then the bit is not installed properly.

HOW TO USE

1. Check the rotational direction
The bit rotates clockwise (viewed from the rear side) by pushing the R-side of the pushing button. The L-side of the pushing button is pushed to turn the bit counterclockwise (See Fig. 7) (The (L) and (R) marks are provided on the body).

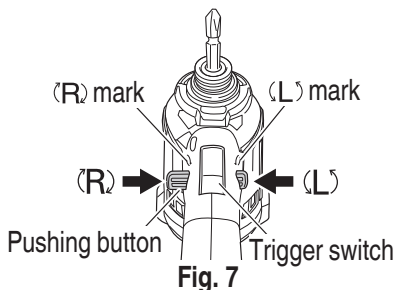

Fig. 7

CAUTION

The pushing button cannot be switched while the impact driver is turning. To switch the pushing button, stop the impact driver, then set the pushing button.

2. Switch operation
 - Make sure to securely hold the tool during operation. Failure to do so can result in accidents or injuries. (Fig. 8)
 - When the trigger switch is depressed, the tool rotates. When the trigger is released, the tool stops.
 - The rotational speed can be controlled by varying the amount that the trigger switch is pulled. Speed is low when the trigger switch is pulled slightly and increases as the trigger switch is pulled more.
 - When releasing the trigger switch, the brake will be applied for immediate stopping.

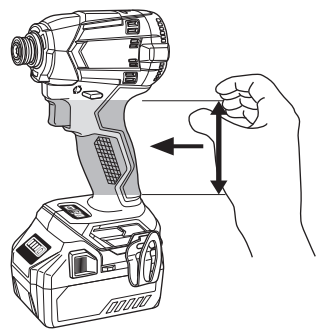

Fig. 8

NOTE

A buzzing noise is produced when the motor is about to rotate. This is only a noise, not a machine failure.

3. Using the hook
The hook is used to hang up the power tool to your waist belt while working.

CAUTION

- **When using the hook, hang up the power tool firmly not to drop accidentally. If the power tool is dropped, it may lead to an accident.**
- **When carrying the power tool with hooked to your waist belt, do not fit any bit to the tip of power tool. If the sharp bit such as drill is fitted to the power tool when carrying it with hooked to your waist belt, you will be injured.**
- **Install securely the hook. Unless the hook is securely installed, it may cause an injury while using.**

English

- (1) Removing the hook.
Remove the screws fixing the hook with Philips screw driver. (**Fig. 9**)
- (2) Replacing the hook and tightening the screws.
Install securely the hook in the groove of power tool and tighten the screws to fix the hook firmly. (**Fig. 10**)

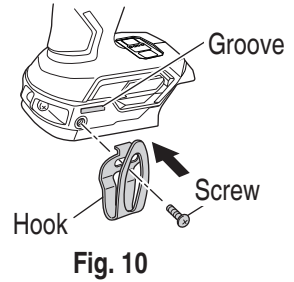
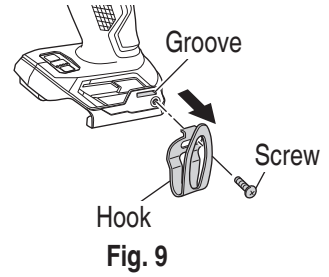

4. Remaining battery indicator
You can check the battery's remaining capacity by pressing the remaining battery indicator switch to light the indicator lamp. (**Fig. 11, Table 4**)

The indicator will shut off approximately 3 seconds after the remaining battery indicator switch is pressed.

It is best to use the remaining battery indicator as a guide since there are slight differences such as ambient temperature and the condition of the battery.

Also, the remaining battery indicator may vary from those equipped to a tool or charger.

Remaining battery indicator lamp Remaining battery indicator switch

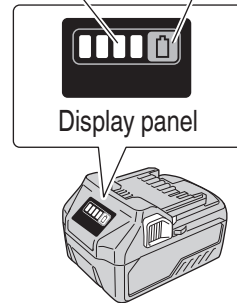

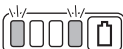

Table 4

State of lamp	Battery Remaining Power
	Lights ; The battery remaining power is over 75%
	Lights ; The battery remaining power is 50%–75%.
	Lights ; The battery remaining power is 25%–50%.
	Lights ; The battery remaining power is less than 25%

	Blinks ; The battery remaining power is nearly empty. Recharge the battery soonest possible.
	Blinks ; Output suspended due to high temperature. Remove the battery from the tool and allow it to fully cool down.
	Blinks ; Output suspended due to failure or malfunction. The problem may be the battery so please contact your dealer.

As the remaining battery indicator shows somewhat differently depending on ambient temperature and battery characteristics, read it as a reference.

NOTE

Do not give a strong shock to the switch panel or break it. It may lead to a trouble.

5. How to use the LED light
By pressing the light section switch on the switch panel, the LED light mode changes as **Table 5**.

(Fig. 12)

To prevent the battery power consumption, turn off the LED light frequently.

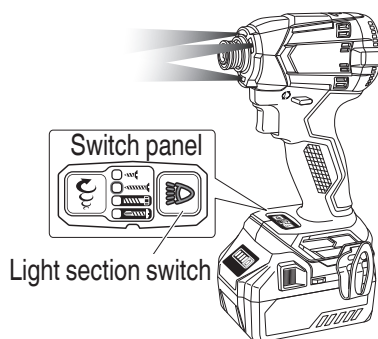

Fig. 12

Table 5

	Always-ON mode	SW interlocked mode	Always-OFF mode
State	Always ON (turn off after 2 minutes)	Light only SW-ON	Always OFF

CAUTION

- Do not expose directly your eye to the light by looking into the light. If your eye is continuously exposed to the light, your eye will be hurt.
- Wipe off any dirt or grime attached to the lens of the LED light with a soft cloth, being careful not to scratch the lens. Scratches on the lens of the LED light can result in decreased brightness.

NOTE

To prevent the battery power consumption caused by forgetting to turn off the LED light, the light goes off automatically in about 2 minutes.

English

6. Tightening mode selector function

CAUTION

- Do not subject the switch panel to shock or damage.
- Select tightening mode while the trigger switch is released. Failure to do so could result in malfunction.

- (1) Tightening mode selector switch
By using the Tightening mode selector switch, the tightening torque can be adjusted according to the type of work.

The Tightening mode switches between 5 different modes each time the Tightening mode selector switch is pressed.

Upon pulling the trigger switch in bolt single mode, the driver will automatically stop after applying a number of impacts.

Soft / power / bolt and self drilling screw mode will commence impact upon pulling the trigger switch and will continuously apply impact without auto-stopping.

Soft mode is a mode that does not inflict damage on thin nails or decorative materials.

Power mode can be used for normal work up to heavy load work.

Bolt mode has a short pull margin for the trigger switch, making the driver ideal for high-speed tightening work.

Bolt single mode controls the impact, allowing control of the tightening force. Use this mode for delicate work such as tightening bolts for racks, fences, furniture, etc.

Self drilling screw mode is ideal for tightening self drilling screws by reducing the chances of overtightening that could result in severing the screw head, breaking the screw, or slippage.

Tightening mode selector switch

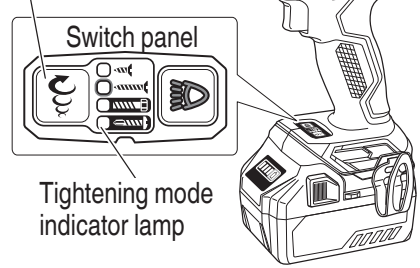
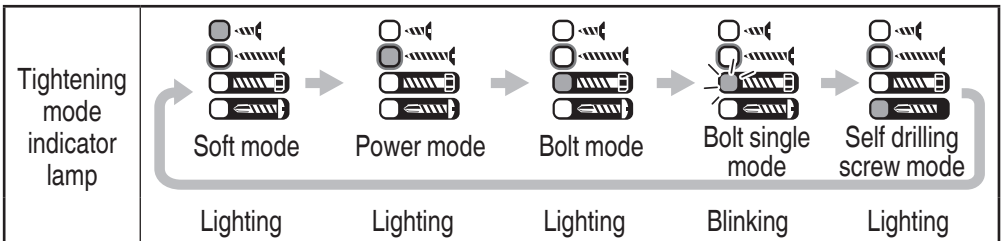

Fig. 13



NOTE

- The appropriate mode differs depending on the screw and the material being screwed. Drive in a few test screws and adjust the mode setting accordingly.
- The tightening mode selector switch can only be set after the battery has been installed in the driver and the trigger switch has been pulled once.

Examples of tightening mode selector function settings

	Soft mode	Power mode	Bolt mode	Bolt single mode	Self drilling screw mode
Rotation speed	0–900 /min	3400 /min	0–2900 /min		3700 /min
Use	“Delicate work” Tightening small diameter screws (M6 or similar), etc.	“Normal work” Tightening short screws, Affixing plasterboard, etc. “Heavy load work” Tightening long screws, coach screws, bolts, etc.	“Tightening and loosening nuts and bolts”	“Delicate work” Bolts used for racks, fences, furniture, etc.	Self drilling screw tightening

7. Tightening and loosening screws

Install the bit that matches the screw, line up the bit in the grooves of the head of the screw, then tighten it.

Push the impact driver just enough to keep the bit fitting the head of the screw.

CAUTION

- **Applying the impact driver for too long tightens the screw too much and can break it.**
- **Tightening a screw with the impact driver at an angle to that screw can damage the head of the screw and the proper force will not be transmitted to the screw. Tighten with this impact driver lined up straight with the screw.**

8. Tightening and loosening bolts

A hex. socket matching the bolt or nut must first be selected. Then mount the socket on the anvil, and grip the nut to be tightened with the hex. socket. Holding the tool in line with the bolt, press the power switch to impact the nut for several seconds.

If the nut is only loosely fitted to the bolt, the bolt may turn with the nut, therefore mistaking proper tightening. In this case, stop impact on the nut and hold the bolt head with a wrench before restarting impact, or manually tighten the bolt and nut to prevent them slipping.

English

9. LED light warning signal (Fig. 14)

This product features functions that are designed to protect the tool itself as well as the battery. While the switch is pulled, if any of the safeguard functions are triggered during operation, the LED light will blink as described in **Table 6**. When any of the safeguard functions are triggered, immediately remove your finger from the switch and follow the instructions described under corrective action.

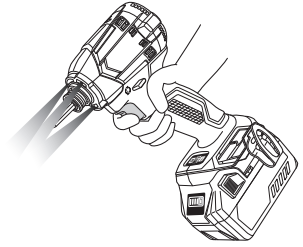

Fig. 14

Table 6

Safeguard Function	LED Light Display	Corrective Action
Temperature Protection	On 0.3 second/off 0.3 second ■ ■ ■ ■	Allow the tool and battery to thoroughly cool.

OPERATIONAL CAUTIONS

1. Resting the unit after continuous work
After use for continuous bolt-tightening work, rest the unit for 15 minutes or so when replacing the battery. The temperature of the motor, switch, etc., will rise if the work is started again immediately after battery replacement, eventually resulting in burnout.

NOTE

Do not touch the metal parts, as it gets very hot during continuous work.

2. Cautions on use of the speed control switch
This switch has a built-in, electronic circuit which steplessly varies the rotation speed. Consequently, when the trigger switch is pulled only slightly (low speed rotation) and the motor is stopped while continuously driving in screws, the components of the electronic circuit parts may overheat and be damaged.
3. Use a tightening time suitable for the screw
The appropriate torque for a screw differs according to the material and size of the screw, and the material being screwed etc., so please use a tightening time suitable for the screw. In particular, if a long tightening time is used in the case of screws smaller than M8, there is a danger of the screw breaking, so please confirm the tightening time and the tightening torque beforehand.
4. Work at a tightening torque suitable for the bolt under impact
The optimum tightening torque for nuts or bolts differs with material and size of the nuts or bolts. An excessively large tightening torque for a small bolt may stretch or break the bolt. The tightening torque increases in proportion to the operation time. Use the correct operating time for the bolt.
5. Holding the tool
Hold the tool firmly with both hands. In this case hold the tool in line with the screw or bolt. It is not necessary to push the tool very hard. Hold the tool with a force just sufficient to counteract the impact force.

6. Confirm the tightening torque
The following factors contribute to a reduction of the tightening torque. So confirm the actual tightening torque needed by screwing up some bolts before the job with a hand torque wrench. Factors affecting the tightening torque are as follows.
- (1) Voltage
When the discharge margin is reached, voltage decreases and tightening torque is lowered.
 - (2) Operating time
The tightening torque increases when the operating time increases. But the tightening torque does not increase above a certain value even if the tool is driven for a long time.
 - (3) Diameter of bolt
The tightening torque differs with the diameter of the bolt. Generally a larger diameter bolt requires larger tightening torque.
 - (4) Tightening conditions
The tightening torque differs according to the torque ratio; class, and length of bolts even when bolts with the same size threads are used. The tightening torque also differs according to the condition of the surface of workpiece through which the bolts are to be tightened. When the bolt and nut turn together, torque is greatly reduced.
 - (5) Tightening torque varies, depending on the battery's charge level.

HOW TO RECHARGE USB DEVICE

WARNING

- **Prior to use, check the connecting USB cable for any defect or damage. Using a defective or damaged USB cable can cause smoke emission or ignition.**
- **When the product is not being used, cover the USB port with the rubber cover. Buildup of dust etc. in the USB port can cause smoke emission or ignition.**

NOTE

- **There may be an occasional pause during USB recharging.**
- **When a USB device is not being charged, remove the USB device from the charger. Failure to do so may not only reduce the battery life of a USB device, but may also result in unexpected accidents.**
- **It may not be possible to charge some USB devices, depending on the type of device.**

English

(1) Select a charging method

Depending on the charge method selected, either the battery is inserted into the charger or the power cord is plugged into an outlet.

- Charging a USB device from a electrical outlet (**Fig. 15-a**).
- Charging a USB device and battery from a electrical outlet. (**Fig. 15-b**)

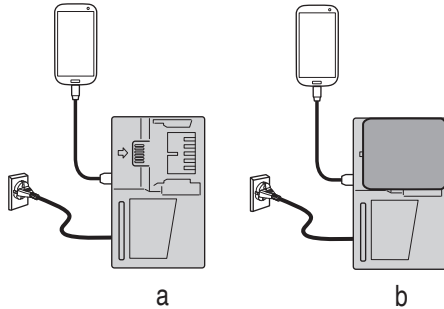

Fig. 15

(2) Connect the USB cable. (**Fig. 16**)

Pull back the rubber cover and firmly plug in a commercially available USB cable (appropriate to the device being charged) into the USB port.

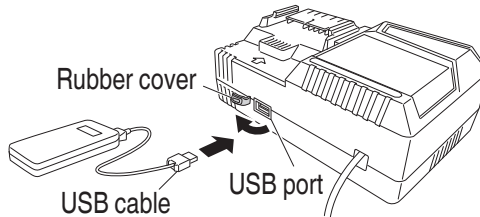

Fig. 16

(3) When charging is completed

- To verify charge status, check the USB device.
- Unplug the power cord from the electrical outlet. (**Fig. 17**)
- Place the rubber cover over the USB port.

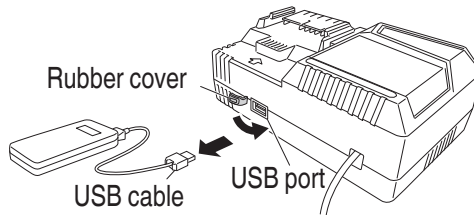

Fig. 17

MAINTENANCE AND INSPECTION

1. Inspecting the driver bit
Using a broken bit or one with a worn out tip is dangerous because the bit can slip. Replace it.
2. Inspecting the mounting screws
Regularly inspect all mounting screws and ensure that they are properly tightened. Should any of the screws be loose, retighten them immediately. Failure to do so may result in serious hazard.
3. Maintenance of the motor
The motor unit winding is the very "heart" of the power tool.
Exercise due care to ensure the winding does not become damaged and/or wet with oil or water.
4. Inspection of terminals (tool and battery)
Check to make sure that swarf and dust have not collected on the terminals.
On occasion check prior, during and after operation.

CAUTION

**Remove any swarf or dust which may have collected on the terminals.
Failure to do so may result in malfunction.**

5. Cleaning of the outside
When the impact driver is stained, wipe with a soft dry cloth or a cloth moistened with soapy water. Do not use chloric solvents, gasoline or paint thinner, as they melt plastics.
6. Storage
Store the impact driver and battery in a place in which the temperature is less than 40°C, and out of reach of children.

NOTE

Storing Lithium-ion Batteries

Make sure the batteries have been fully charged before storing them.

Prolonged storage (3 months or more) of batteries with a low charge may result in performance deterioration, significantly reducing battery usage time or rendering the batteries incapable of holding a charge.

However, significantly reduced battery usage time may be recovered by repeatedly charging and using the batteries two to five times.

If the battery usage time is extremely short despite repeated charging and use, consider the batteries dead and purchase new batteries.

CAUTION

In the operation and maintenance of power tools, the safety regulations and standards prescribed in each country must be observed.

Important notice on the batteries for the HiKOKI cordless power tools

Please always use one of our designated genuine batteries. We cannot guarantee the safety and performance of our cordless power tool when used with batteries other than these designated by us, or when the battery is disassembled and modified (such as disassembly and replacement of cells or other internal parts).

TROUBLESHOOTING

Use the inspections in the table below if the tool does not operate normally. If this does not remedy the problem, consult your dealer or the HiKOKI Authorized Service Center.

1. Power tool

Symptom	Possible cause	Remedy
Tool doesn't run	No remaining battery power	Charge the battery.
	The trigger switch was held down while the battery was inserted.	The safety function was activated. If the trigger switch is released once and then pulled again, the tool will run.
Tool suddenly stopped	Tool was overburdened	Get rid of the problem causing the overburden.
	The battery is overheated.	Let the battery cool down.
	The trigger switch was held down for 5 minutes or more.	This is not a malfunction. The motor was automatically stopped to prevent failure of the tool.
Tool bits - can't be attached - fall off	The shape of the attachment portion doesn't match	Use a bit with a hexagonal shaft that has a width across flats of 6.35 mm.
		If you are using an L-type tool bit, replace it with an S-type bit.
Switch can't be pulled	Forward/reverse selector button is positioned halfway	Press the button firmly into position for the desired direction of rotation.
An abnormal high-pitched noise occurs when the trigger switch is pulled.	The trigger switch is being pulled only slightly.	This is not a malfunction. It does not occur if the trigger switch is pulled more fully.
Screw head slips or comes loose.	Bit number doesn't match with the screw size	Install a suitable bit.
	The bit is worn	Replace with a new bit.

2. Charger

Symptom	Possible cause	Remedy
The charge indicator lamp rapidly flickers purple, and battery charging doesn't begin.	The battery is not inserted all the way.	Insert the battery firmly.
	There is foreign matter in the battery terminal or where the battery is attached.	Remove the foreign matter.
The charge indicator lamp blinks red, and battery charging doesn't begin.	The battery is not inserted all the way.	Insert the battery firmly.
	The battery is overheated.	If left alone, the battery will automatically begin charging if its temperature decreases, but this may reduce battery life. It is recommended that the battery be cooled in a well-ventilated location away from direct sunlight before charging it.
Battery usage time is short even though the battery is fully charged.	The battery's life is depleted.	Replace the battery with a new one.
The battery takes a long time to charge.	The temperature of the battery, the charger, or the surrounding environment is extremely low.	Charge the battery indoors or in another warmer environment.
	The charger's vents are blocked, causing its internal components to overheat.	Avoid blocking the vents.
	The cooling fan is not running.	Contact a HiKOKI Authorized Service Center for repairs.
The USB power lamp has switched off and the USB device has stopped charging.	The battery's capacity has become low.	Replace the battery with one that has capacity remaining.
		Plug the charger's power plug into an electric socket.
USB power lamp does not switch off even though the USB device has finished charging.	The USB power lamp lights up green to indicate that USB charging is possible.	This is not a malfunction.
It is unclear what the charging status of a USB device is, or whether its charging is complete.	The USB power lamp does not switch off even when charging is complete.	Examine the USB device that is charging to confirm its charging status.

English

Symptom	Possible cause	Remedy
Charging of a USB device pauses midway.	The charger was plugged into an electrical socket while the USB device was being charged using the battery as the power source.	This is not a malfunction. The charger pauses USB charging for about 5 seconds when it is differentiating between power sources.
	A battery was inserted into the charger while the USB device was being charged using a power socket as the power source.	
Charging of the USB device pauses midway when the battery and the USB device are being charged at the same time.	The battery has become fully charged.	This is not a malfunction. The charger pauses USB charging for about 5 seconds while it checks whether the battery has successfully completed charging.
Charging of the USB device doesn't start when the battery and the USB device are being charged at the same time.	The remaining battery capacity is extremely low.	This is not a malfunction. When the battery capacity reaches a certain level, USB charging automatically begins.

SELECTING ACCESSORIES

Select accessories that are suited to a specific task.
For details contact HiKOKI Authorized Service Center.

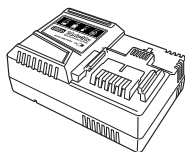

UC18YSL3
(14.4 V-18 V)
Charger



BSL36A18
Battery

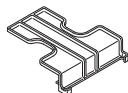

Part Number: 329897
Battery cover

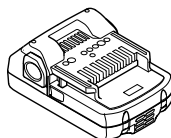

BSL18..

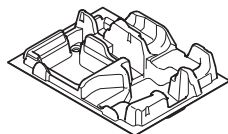

Part Number: 339776

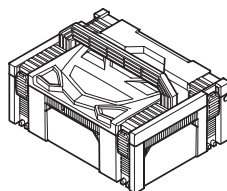

Part Number: 336471
Plastic case (Stackable)



Light Gold: Part Number: 377857
Titanium Silver: Part Number: 377858
Sky Blue: Part Number: 377859
Violet: Part Number: 377860
Signal Red: Part Number: 377861

Color plate

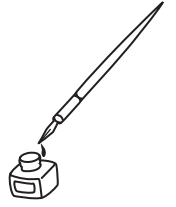

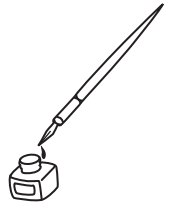

服务中心
高壹工机商业(上海)有限公司
上海市闵行区浦江工业园区三鲁路3585号7幢3楼

制造商
广东高壹工机有限公司
广东省广州市番禺区化龙镇工业路富裕围工业村

Koki Holdings Co., Ltd.

203
编号: C99744921 G
发行日期: 2022年3月
中国印刷