

HiKOKI

充电式吹风机
Cordless Blower

中文
English

RB 18DC

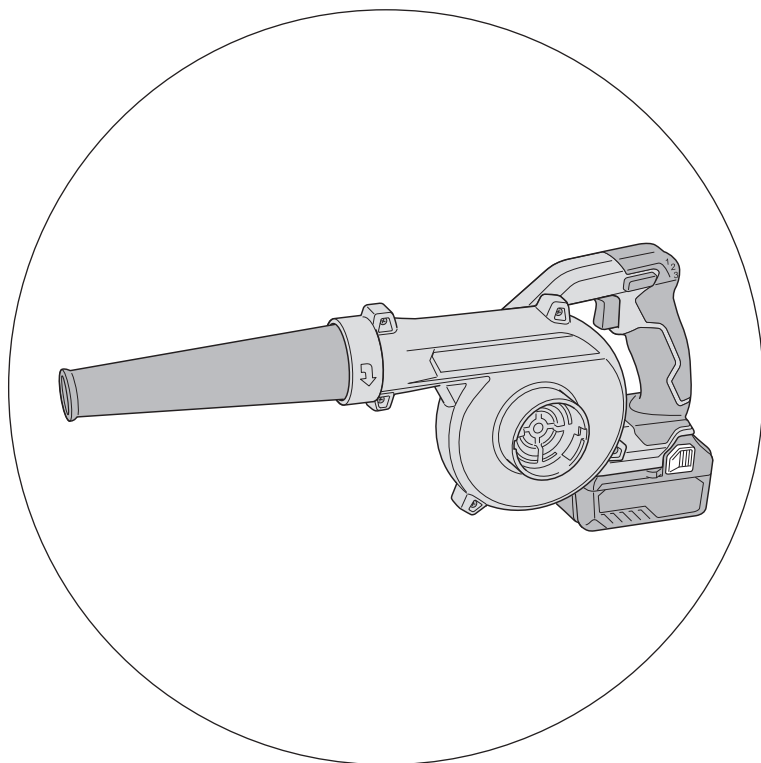

保留备用
Keep for future reference



使用说明书
Handling instructions

目次

| | | | |
|----------------------|----|------------------|----|
| 电动工具通用安全警告..... | 2 | 用途..... | 11 |
| 充电式吹风机安全警告..... | 5 | 电池的拆卸 / 安装法..... | 11 |
| 其他安全警告..... | 6 | 充电..... | 12 |
| 锂离子电池使用注意事项..... | 7 | 作业之前..... | 14 |
| 锂离子电池运输..... | 8 | 装卸喷嘴和集尘袋..... | 15 |
| USB 设备连接器使用注意事项..... | 9 | 开关和风量控制..... | 16 |
| 符号..... | 9 | USB 设备的充电方法..... | 17 |
| 零件名称..... | 9 | 维护和检查..... | 18 |
| 规格..... | 10 | 故障排除..... | 19 |
| 标准附件..... | 11 | 选择附件..... | 21 |

电动工具通用安全警告

警告！

阅读电动工具附带的所有安全警告、说明、插图和规格说明。

不遵照以下说明会导致电击、着火和 / 或严重伤害。

保存所有警告和说明书以备查阅。

在所有下列的警告中术语“电动工具”指市电驱动（有线）电动工具或电池驱动（无线）电动工具。

1) 工作场地的安全

a) 保持工作场地清洁和明亮。

混乱和黑暗的场地会引发事故。

b) 不要在易爆环境，如有易燃液体、气体或粉尘的环境下操作电动工具。

电动工具产生的火花会点燃粉尘或气体。

c) 让儿童和旁观者离开后操作电动工具。

注意力不集中会使操作者失去对工具的控制。

2) 电气安全

a) 电动工具插头必须与插座相配。

绝不能以任何方式改装插头。

需接地的电动工具不能使用任何转换插头。

未经改装的插头和相配的插座将减少电击危险。

b) 避免人体接触接地表面，如管道、散热片和冰箱。

如果你身体接地会增加电击危险。

c) 不得将电动工具暴露在雨中或潮湿环境中。

水进入电动工具将增加电击危险。

- d) 不得滥用电线。绝不能用电线搬运、拉动电动工具或拔出其插头。使电线远离热源、油、锐边或运动部件。
受损或缠绕的软线会增加电击危险。
- e) 当在户外使用电动工具时，使用适合户外使用的外接软线。
适合户外使用的软线将减少电击危险。
- f) 如果在潮湿环境下操作电动工具是不可避免的，应使用剩余电流动作保护器（RCD）。
使用RCD可减小电击危险。

3) 人身安全

- a) 保持警觉，当操作电动工具时关注所从事的操作并保持清醒。
当你感到疲倦，或在有药物、酒精或治疗反应时，不要操作电动工具。
在操作电动工具时瞬间的疏忽会导致严重人身伤害。
- b) 使用个人防护装置。始终佩戴护目镜。
安全装置，诸如适当条件下使用防尘面具、防滑安全鞋、安全帽、听力防护等装置能减少人身伤害。
- c) 防止意外起动。确保开关在连接电源和 / 或电池盒、拿起或搬运工具时处于关断位置。
手指放在已接通电源的开关上或开关处于接通时插入插头可能会导致危险。
- d) 在电动工具接通之前，拿掉所有调节钥匙或扳手。
遗留在电动工具旋转零件上的扳手或钥匙会导致人身伤害。
- e) 手不要伸展得太长。时刻注意立足点和身体平衡。
这样在意外情况下能很好地控制电动工具。
- f) 着装适当。不要穿宽松衣服或佩戴饰品。让衣服、手套和头发远离运动部件。
宽松衣服、佩饰或长发可能会卷入运动部件中。
- g) 如果提供了与排屑、集尘设备连接用的装置，要确保它们连接完好且使用得当。
使用这些装置可减少尘屑引起的危险。
- h) 请勿因频繁使用工具的熟悉感而掉以轻心，忽视工具的安全性原则。
粗心的行为可能会导致瞬间发生严重伤害。

4) 电动工具使用和注意事项

- a) 不要滥用电动工具，根据用途使用适当的电动工具。
选用适当设计的电动工具会使你工作更有效、更安全。
- b) 如果开关不能接通或关断工具电源，则不能使用该电动工具。
不能用开关来控制的电动工具是危险的且必须进行修理。
- c) 在进行任何调整、更换附件或存放电动工具之前，必须从电源上拔掉插头和 / 或取下电池盒（如果可拆卸）。
这种防护性措施将减少工具意外起动的危险。

中文

- d) 将闲置不用的电动工具贮存在儿童所及范围之外，并且不要让不熟悉电动工具或对这些说明不了解的人操作电动工具。
电动工具在未经培训的用户手中是危险的。
- e) 维护电动工具和附件。检查运动件是否调整到位或卡住，检查零件破损情况和影响电动工具运行的其他状况。如有损坏，电动工具应在使用前修理好。
许多事故由维护不良的电动工具引发。
- f) 保持切削刀具锋利和清洁。
保养良好的有锋利切削刃的刀具不易卡住而且容易控制。
- g) 按照使用说明书，考虑作业条件和进行的作业来使用电动工具、附件和工具的刀头等。
将电动工具用于那些与其用途不符的操作可能会导致危险。
- h) 保持手柄和抓握表面干燥、清洁，远离油和油脂。
如果手柄和抓握表面湿滑，可能导致在发生意外情况时，无法安全操作和控制工具。

5) 电池式工具使用和注意事项

- a) 只用制造商规定的充电器充电。
将适用于某种电池盒的充电器用到其他电池盒时会发生着火危险。
- b) 只使用配有特制电池盒的电动工具。
使用其他电池盒会发生损坏和着火危险。
- c) 当电池盒不用时，将它远离其他金属物体，例如回形针、硬币、钥匙、钉子、螺钉或其他小金属物体，以防一端与另一端连接。
电池端部短路会引起燃烧或火灾。
- d) 在滥用条件下，液体会从电池中溅出；避免接触。如果无意间碰到了，用水冲洗。如果液体碰到了眼睛，还要寻求医疗帮助。
从电池中溅出的液体会发生腐蚀或燃烧。
- e) 请勿使用损坏或改装的电池盒或工具。
损坏或改装的电池可能会引发突发状况，导致火灾、爆炸或受伤。
- f) 请勿将电池盒或工具暴露在有火源或高温环境中。
如果暴露在有火源或 130 度以上高温的环境中，可能引起爆炸。
- g) 请完全按照充电说明进行操作，不要在说明中规定的温度范围外的环境中对电池盒或工具充电。
充电不当或在规定温度范围外的环境中充电可能会导致电池损坏，增加发生火灾的风险。

6) 维修

- a) 将你的电动工具送交专业维修人员，使用同样的备件进行修理。
这样将确保所维修的电动工具的安全性。
- b) 请勿维修已损坏的电池盒。
需由制造商或经授权的服务供应商进行维修。

注意！

不可让儿童和体弱人士靠近工作场所。

应将不使用的工具存放在儿童和体弱人士接触不到的地方。

充电式吹风机安全警告

1. 使用时请勿将手或脸接近充电式吹风机的送风口或进气口。
否则可能会导致人身伤害。
2. 当清洁配电板等电导体时，请确保导体和电动工具之间留有足够空间。此外，清洁时请确保安装喷嘴。
清洁导体时如未安装喷嘴，将会导致触电。
3. 请勿堵塞送风口和 / 或进气口。此外，请勿让灰尘积聚在进气口。
堵塞送风口或进气口会使马达转速异常加快，可能会损坏电动工具内的风扇并导致马达过热。
4. 请勿使用电动工具给气球或泳圈充气。
5. 请勿在有油漆、涂料、苯、稀释剂或汽油等易燃物的地方使用。也请勿让未熄灭的烟蒂等物被吸入。
否则可能会造成爆炸或起火。
6. 请勿在火炉等会发出高温的物体附近使用；请勿朝未熄灭的烟蒂吹气；也请勿点燃或熄灭火焰。
否则可能会造成起火。
7. 请勿在含有高剂量化学品的环境中使用。
否则塑料部位可能会软化和损坏，并造成人身伤害。
8. 如果发现本机正在产生异常高温、工作不正常或出现异常噪音，请立即停止使用，并关闭电源。请让本机的经销商或 HiKOKI 授权服务中心检查和修理。
操作出现异常而依然继续使用时，可能会造成人身伤害。
9. 如果本机意外跌落或撞击其他物体，请彻底检查其是否发生破裂、破损或变形等。
如果本机破裂、破损或变形，可能会造成人身伤害。
10. 请勿在进气口或送风口内放置诸如螺钉之类的物体。
否则可能会损坏工具的内部零件。
11. 吹风时，请将喷嘴安装在送风口上。集尘时，请将喷嘴安装在进气口上，并将集尘袋安装在送风口上。
12. 请勿使用该工具吸入诸如水之类的液体或湿灰尘颗粒，或者诸如玻璃碎片、切割工件、钉子、螺钉、砾石或未熄灭的烟蒂之类的物体。
13. 请勿使用工业油或油脂（切削油、润滑油等），或在化学物品附近使用。
否则可能会导致零件劣化或损坏。
14. 如果用充电式吹风机来吹或清洁粘性粉体或尘粒，请进行彻底的检查。
粉体或尘粒可能会被吸入并粘在里面，使叶片损坏或引起受伤。

中文

15. 请勿触碰移动的部件。
请勿将手、手指或身体的其他部位靠近工具的移动部件。
16. 请勿使工具在无人值守的状态下运转。关闭电源。
请勿在工具完全停止前离开。
17. 在高处操作该工具时，需确保作业位置下方无人。
18. 请小心在干燥的环境中吹扫大量微细的粉尘，因其会引起静电积聚并导致意外放电。
19. 切勿对准人或动物。机器会高速吹落小物体并可能导致人身伤害。
20. 切勿在不稳固的地点进行操作，例如站在梯子或梯凳上。
否则可能导致人身伤害。
21. 请勿用其他物体撞击工具；避免跌落工具等强烈撞击；也不可弄湿工具。
以上任一操作均可能损坏内置的精密零件并导致故障。
22. 操作前，请清除该区域中可能导致人身伤害或事故的任何物体。
23. 操作中，请勿窥视送风口。
24. 请远离进气口，以免卷入工作服。
25. 如有任何异物进入进气口并停止送风，请立即关闭工具，取出电池，然后清除异物。
26. 运输中的注意事项
 - 松开机身上的开关，并取出电池。
 - 扶住机身的把手搬运。
 - 车辆运输时，请采取适当的步骤以防其跌落或损坏。

其他安全警告

1. 务请在 0°C — 40°C 的温度下进行充电。温度低于 0°C 将会导致充电过度，极其危险。电池不能在高于 40°C 的温度下充电。
最适合于充电的温度是 20 — 25°C 。
2. 不要连续使用充电器。
一次充电完毕后，在15分钟内不要再次使用该充电器对电池充电。
3. 请勿让杂质进入充电式电池连结口内。
4. 切勿拆卸充电式电池与充电器。
5. 切勿使充电式电池短路。电池短路会引起强电流和过热。从而烧坏电池。
6. 请勿将电池丢入火中。电池受热将会爆炸。
7. 充电后电池寿命太短不够使用时，请尽快将电池送往经销店。请勿将用过的电池乱丢。
8. 请勿将异物插入充电器的通风口。若将金属异物或易燃物插入通风口，将会引起触电事故或使充电器受损。
9. 长时间连续使用本机，可能导致机体过热，对马达及开关造成损害。因此，机壳变热时，请让工具休息一段时间。

10. 请确保蓄电池安装牢固。电池松动后，可能脱落并引起事故。
11. 请勿使用工具或电池端子（电池安装部位）明显变形的产品。
否则，安装电池后可能会短路，造成冒烟或起火。
12. 请清除工具端子（电池安装部位）上的削屑和灰尘。
 - 使用前，请确保电池上没有堆积削屑和灰尘。
 - 在使用过程中，请尽量避免工具上的削屑或灰尘掉落到电池上。
 - 暂停不使用工具时或使用后，应将工具存放在不会掉落削屑或灰尘的地方。
否则可能短路，造成冒烟或起火。
13. 请在-5—40℃环境下使用本工具及电池。

锂离子电池使用注意事项

为延长使用期限，锂离子电池备配停止输出的保护功能。

若是在使用本产品时发生下列 1 和 3 的情况，即使按下开关，马达也可能停止。这并非故障，而是启动保护功能的结果。

1. 在残留的电池电力即将耗尽时，马达会停止。
在这种情况下，请立即予以充电。
2. 若工具超过负荷，马达亦可能停止。在这种情况下，请松开工具的开关，试着消除超过负荷的原因。之后您就可以再度使用。
3. 若电池在过载工作情况下过热，电池电力可能会中止。
在这种情况下，请停止使用电池，让电池冷却。之后您就可以再度使用。

此外，请留心下列的警告及注意事项。

警告！

为防止发生电池漏电、发热、冒烟、爆炸及提前点燃，请确保留意下列事项。

1. 确保电池上没有堆积削屑及灰尘。
 - 在工作时确定削屑及灰尘没有掉落在电池上。
 - 确定所有工作时掉落在电动工具上的削屑和灰尘没有堆积在电池上。
 - 请勿将未使用的电池存放在曝露于削屑和灰尘的位置。
 - 在存放电池之前，请清除任何可能附着在上面的削屑和灰尘，并请切勿将它与金属零件（螺丝、钉子等）存放在一起。
2. 请勿以钉子等利器刺穿电池、以铁锤敲打、踩踏、丢掷电池，或将其剧烈撞击。
3. 切勿使用明显损坏或变形的电池。
4. 使用电池时请勿颠倒电极。
5. 请勿直接连接电源插座或汽车点烟器孔座。
6. 请依规定方式使用电池，切勿移作他用。
7. 如果已过了再充电时间，电池仍无法完成充电，请立即停止继续再充电。
8. 请勿将电池放置于高温或高压处，例如微波炉、烘干机或高压容器内。
9. 在发觉有渗漏或异味时，请勿接近远离火源。

中文

10. 请勿在会产生强烈静电的地方使用。
11. 如有电池渗漏、异味、发热、褪色或变形，或在使用、充电或存放时出现任何异常，请立即将它从装备或电池充电器拆下，并停止使用。
12. 请勿浸泡电池或让任何液体流入电池内部。导电液体进入（如水），可能造成电池损坏，甚至可导致火灾或爆炸。将电池存放在阴凉、干燥的地方，远离易燃物品。必须避免将电池置于腐蚀性气体环境中。

注意！

1. 若电池渗漏出的液体进入您的眼睛，请勿揉搓眼睛，并以自来水等干净清水充分冲洗，立刻送医。
若不加以处理，液体可能会导致眼睛不适。
2. 若液体渗漏至您的皮肤或衣物，请立即以自来水等清水冲洗。
上述情况可能会使皮肤受到刺激。
3. 若初次使用电池时发现生锈、异味、过热、褪色、变形及 / 或其它异常情况时，请勿使用并将该电池退还给供货商或厂商。

警告！

如果有导电异物进入锂电池，可能发生短路，并有发生火灾危险的可能。请在贮存电池时，遵守如下事项。

- 请不要在电池盒内放置导电物体，如钉子、钢丝、铜丝或其他电线。
- 或者将电池装在电动工具中，或者在牢固按入电池盖并挡住通风孔后再存放，以防止短路（参照图 1）。



图 1

锂离子运输

当运输一个锂离子电池，请注意以下预防措施。

警告！

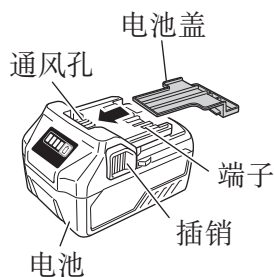
告知运输公司，包装内包含一个锂离子电池，告知该公司其功率输出并且要按照运输公司的指引安排运输。

- 功率输出超过 100 Wh 的锂离子电池被视作危险物品运输分类并且需要特别申请程序。
- 对于境外运输，您必须遵守国际法以及输入国的规章和条例。



图 2

USB 设备连接器使用注意事项

发生意外情况时，本产品连接的 USB 中保存的数据可能发生损坏或丢失。使用本产品前，请务必备份 USB 设备中的数据。

请注意，如 USB 设备中存储的数据发生损坏、丢失或连接的设备发生损坏，本公司概不负责。

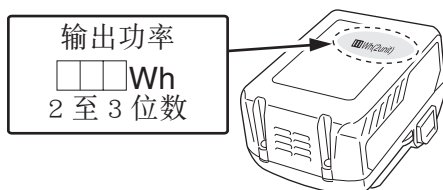
符号

警告！

如下所示的符号用于本机。使用前请务必理解其含意。

| | | | |
|--|---------------------|---|----------|
|  | 为降低伤害风险，用户必须阅读使用说明书 | n_0 | 空载转速 |
|  | 直流电 | /min | 每分钟的振动次数 |
| V | 额定电压 |  | 警告 |

零件名称

1. 电动工具



图 3

2. 电池 (选购件)

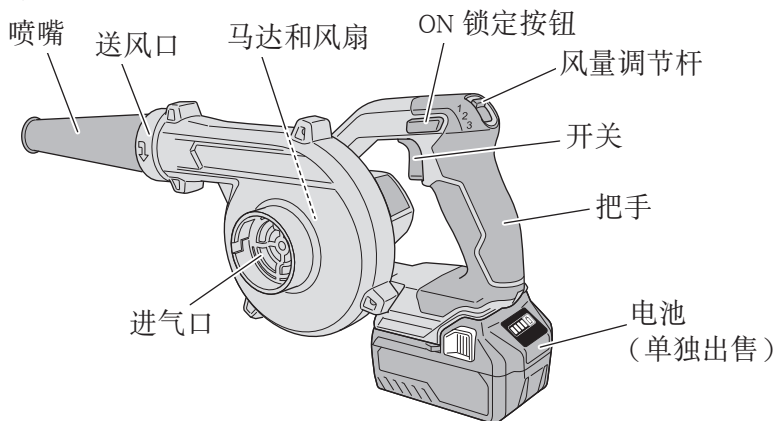

图 4

3. 电池充电器 (选购件)

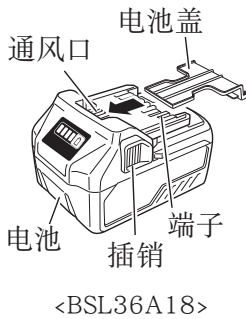

图 5

规格

电动工具

| | | |
|-----------|--|---------|
| 型式 | RB18DC | |
| 电压 | 18V | |
| 空载速度 *1 | 0—20000/min | |
| 风速 | 最大 *2 | 0—95m/s |
| | 平均 *2 | 0—78m/s |
| 风量 *3 | 0—3.5m ³ /min | |
| 连续操作时间 *4 | 3 : 约 20 分钟 | |
| | 2 : 约 55 分钟 | |
| | 1 : 约 130 分钟 | |
| 电池 *5 | BSL36A18 : 锂离子 36V / 18V (2.5Ah / 5.0Ah 10 节) | |
| 重量 | 1.8kg (安装 BSL36A18) | |

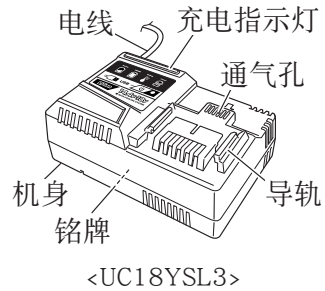
*1 BSL36A18, 充满电时

*2 带喷嘴

*3 无喷嘴

*4 仅供参考。结果会根据操作环境和电池条件等情况而有所不同。

*5 本工具不适用以下电池 (BSL3660/3626/3620)。

充电器（单独出售）

| | |
|------|-------------|
| 型式 | UC18YSL3 |
| 充电电压 | 14.4V - 18V |
| 重量 | 0.6kg |

标准附件

除了主机（1 台）外，产品包中还包括表中所列的附件。

表 1

| | | |
|----|---|--------|
| | | RB18DC |
| | | (NN) |
| 喷嘴 |  | 1 |

用途

- 伐木场、卷烟厂、纺织厂等内的清洁设施和设备。
- 修理店内的清洁设施和设备。
- 吹风操作。

电池的拆卸 / 安装法

1. 电池的拆卸法

请先紧抓住把手，然后再推压电池插销（2 个）以拆下电池（图 6）。

注意！

切勿使电池短路。

2. 电池的安装法

插入电池时请注意极性（图 6）



图 6

充电

使用电动工具之前，按下述方法将电池进行充电。

1. 将充电器的电源线连接到插座。

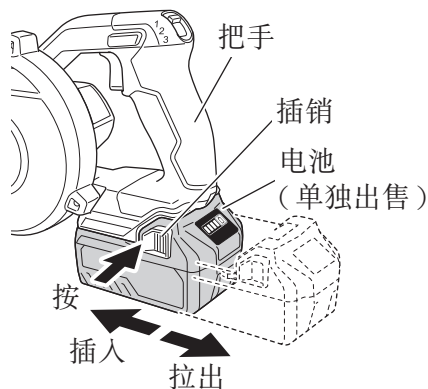
将充电器插头连接到插座时，指示灯闪烁红色（间隔为 1 秒）。

2. 将电池插入充电器。

如图 7 所示，将电池紧紧地插入充电器。

3. 充电

将电池插入充电器后，充电指示灯将呈蓝色闪烁。

电池完全充电后，充电指示灯将持续点亮呈绿色。

（参照表 2）









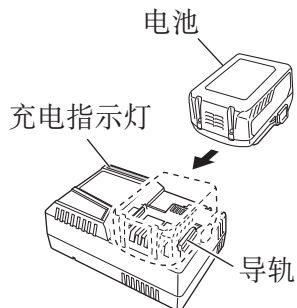

图 7

(1) 充电指示灯的指示状态

根据充电器或可充电电池的情况，充电指示灯的显示如表 2 所示。

表 2

| 充电指示灯的指示状态 | | | | |
|-----------------------------|----------|---|--|--------------------------------|
| 充电指示灯 (红 / 蓝 / 绿 / 紫) | 充电前 | 闪烁 (红)  | 点亮 0.5 秒钟。不点亮 0.5 秒钟。(熄灭 0.5 秒钟) | 插入电源 |
| | 充电时 | 闪烁 (蓝)  | 点亮 0.5 秒钟。不点亮 1 秒 钟。(熄灭 1 秒钟) | 电池电量低于 50% |
| | | 闪烁 (蓝)  | 点亮 1 秒钟。不点亮 0.5 秒钟。(熄灭 0.5 秒钟) | 电池电量低于 80% |
| | | 点亮 (蓝)  | 连续点亮 | 电池电量高于 80% |
| | 充电完成 | 点亮 (绿)  | 连续点亮 (发出持续蜂鸣声：约 6 秒) | |
| | 过热 待机 | 闪烁 (红)  | 点亮 0.3 秒钟。不点亮 0.3 秒钟。(熄灭 0.3 秒钟) | 电池过热。无法充 电 (电池冷却后将 开始充电) |
| | 无法 充电 | 闪动 (紫色)  | 点亮 0.1 秒钟。不点亮 0.1 秒钟。(熄灭 0.1 秒钟) (发出断续蜂鸣声：约 2 秒) | 电池或充电器故障 |

(2) 可充电电池温度和充电时间相关资料
温度和充电时间如表 3 所示。

表 3

| 充电器 | | UC18YSL3 | | | | | |
|-----|------------------|------------|---|--|--|--|---|
| 电池 | 电池类型 | 锂离子电池 | | | | | |
| | 电池可充电温度 | 0°C – 50°C | | | | | |
| | 充电电压 | V | 14.4 | | 18 | | |
| | 充电时间 (环境温度 20°C) | 分钟 | BSL14xx 系列 | | BSL18xx 系列 | | 多电压系列 |
| | | | (4 节) | (8 节) | (5 节) | (10 节) | (10 节) |
| | | | BSL1415S : 15 BSL1415 : 15 BSL1415X : 15 BSL1420 : 20 BSL1425 : 25 BSL1430C : 30 | BSL1430 : 20 BSL1440 : 26 BSL1450 : 32 BSL1460 : 38 | BSL1815S : 15 BSL1815 : 15 BSL1815X : 15 BSL1820 : 20 BSL1825 : 25 BSL1830C : 30 BSL1850C : 32 | BSL1830 : 20 BSL1840 : 26 BSL1850 : 32 BSL1860 : 38 | BSL36A18 : 32 BSL36B18 : 52 BSL36C18 : 20 |
| USB | 充电电压 | V | 5 | | | | |
| | 充电电流 | A | 2 | | | | |

注：

充电时间可能会因环境温度和电源电压而异。

4. 从电源插座拔下充电器的电源线。

5. 握紧充电器并取出电池。

注：

充电后，先将电池从充电器中取出，然后妥善保存。

关于新电池的放电

新电池内部的化学物质未被激活或电池长时间不使用时，初次或第二次使用时需要将其放电至较低电量。这只是暂时现象，将电池充电 2-3 次即可恢复为充电所需的正常时间。

较长时间保持电池性能的方法

(1) 在电池电力完全耗尽之前进行充电。

感到电动工具的能力变弱时，请停止使用并给电池充电。若您继续使用电动工具并耗尽电力，电池可能会损坏或其使用寿命缩短。

中文

(2) 避免在高温环境中充电。

使用后可充电电池的温度将迅速升高。若使用后立即对这种电池进行充电，其内部化学物质会劣化，电池使用寿命将缩短。请稍等片刻，待电池冷却后再进行充电。

注意！

- 如果电池长时间放置在阳光直射的地方或者刚刚使用完毕时，电池会变热。如果此时对电池充电，充电器的充电指示灯会点亮 0.3 秒钟，然后熄灭 0.3 秒钟（熄灭 0.3 秒钟）。此时请等待电池冷却后再开始充电。
- 充电指示灯闪动（闪动间隔为 0.2 秒钟）时，请检查充电器的电池连接器内是否有异物并加以清除。如没有异物，则可能是电池或充电器发生了故障。请将其送往当地授权服务中心。
- 因内置的微电脑需要约 3 秒钟才能确认正用 UC18YSL3 充电的电池已被取出，因此请等待 3 秒钟后再重新插入电池继续充电。如果在不到 3 秒内就插入电池，则电池可能充电不正常。

作业之前

1. 工作环境的准备和检查

请按下列注意事项检查工作环境是否适当。

2. 剩余电池电量指示灯

可以按下剩余电池电量指示灯开关点亮指示灯，查看电池的剩余电量。（图 8，表 4）

按住剩余电池电量指示灯开关约 3 秒后，指示灯将熄灭。

环境温度和电池状态可能会对剩余电池电量产生轻微的影响，因此，建议您仅将指示灯作为参考。

此外，电动工具或充电器上的剩余电池电量指示灯可能有所不同。

剩余电池
电量指示灯

剩余电池电量
指示灯开关







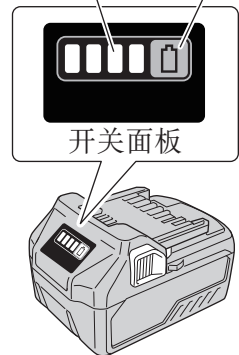
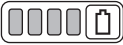

图 8

表 4

| 指示灯状态 | 电池剩余电量 |
|---|-------------------------------------|
|  | 点亮； 电池剩余电量超过 75% |
|  | 点亮； 电池剩余电量为50%—75% |
|  | 点亮； 电池剩余电量为25%—50% |
|  | 点亮； 电池剩余电量不到 25% |
|  | 闪烁； 电池剩余电量即将耗尽。请尽快对电池进行充电。 |
|  | 闪烁； 因高温暂停输出从电动工具中取下电池，让电池完全冷却。 |
|  | 闪烁； 因失败或故障暂停输出。电池可能出现故障，请与经销商联系。 |

环境温度和电池特性不同，则所显示的电池剩余电量也会有些许不同，以上内容仅供参考。

注：

请勿强烈撞击或破坏开关面板。否则可能会导致故障。

装卸喷嘴和集尘袋

警告！

为避免发生严重事故，请确保开关处于关断位置，并取出电池。

1. 安装喷嘴

将喷嘴外的销插入送风口上的凹槽内，并按图 9 所示的箭头方向将喷嘴转到底，直至听见喀哒声为止。

要拆下喷嘴时，请按与上面相反的步骤操作。

注：

在吹风操作前，请在附近无人处吹风，以确保工具上没有任何残留物。



图 9

中文

2. 将充电式吹风机用于集尘时

(1) 安装集尘袋

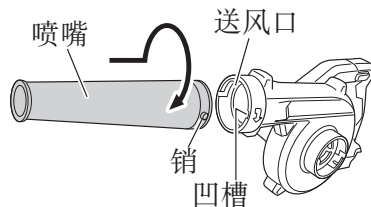
按与上面所述的安装喷嘴相同的步骤(图 10), 将集尘袋装在送风口上。

(2) 安装喷嘴

将喷嘴外的销插入进气口上的凹槽内, 并按图 11 所示的箭头方向将喷嘴转到底, 直至听见喀哒声为止。



图 10



图 11

开关和风量控制

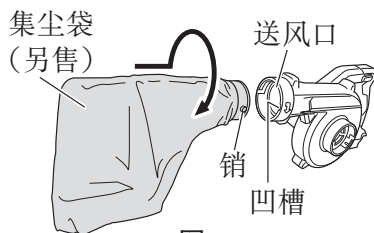
○ 开关操作 (图 12)。

压下开关, 则吹风机旋转。松开开关, 则吹风机停止。

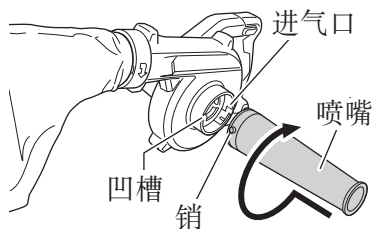
可调节为可变风量, 具体取决于开关的拨入量。

○ 连续操作 (图 12)。

将开关拨到底, 然后按 ON 锁定按钮将工具的操作状态锁定到位, 以进行连续操作。

可通过按下开关的任一侧来激活 ON 锁定按钮。



图 12

如要中止操作, 请再次拨入开关以松开 ON 锁定按钮。

○ 风量控制功能 (图 13)

完全拨入开关时, 可以将风量调节为高速、中速或低速。

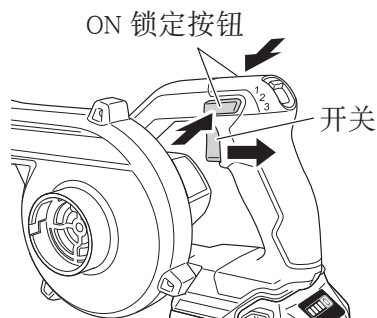
| 控制杆位置 | 风量 |
|-------|----|
| 3 | 高速 |
| 2 | 中速 |
| 1 | 低速 |



图 13

注：

在运行过程中，设备会产生静电，可能导致马达停止运行。
这是一种保护功能而不是故障，再次拨入开关以重新启动马达。

USB 设备的充电方法

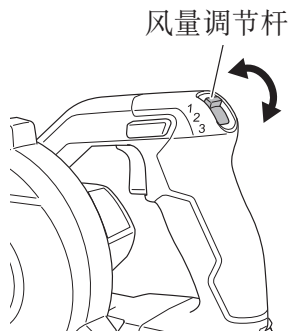
警告！

- 使用之前请检查 USB 连接线缆是否有破损或损坏。
使用有破损或损坏的 USB 线缆可能会导致冒烟或着火。
- 不使用产品时，请用橡胶盖封好 USB 端口。
USB 端口中落入灰尘等可能会导致冒烟或着火。

注：

- USB 充电过程中，可能会有偶尔暂停。
- USB 设备未充电时，请将充电器上拨下 USB 设备。
否则不仅会减少 USB 设备的电池寿命，还会导致意外事故。

- 根据设备类型，可能无法对部分 USB 设备进行充电。

(1) 选择充电方式

根据所选的充电方式，将电池插入充电器或连接电源线插入插座。

- 将 USB 设备插入插座进行充电（图 14-a）。
- 将 USB 设备和电池插入插座进行充电。（图 14-b）

(2) 连接 USB 线缆。（图 15）

拨下橡胶盖并将市售的 USB 线缆（匹配充电的设备）紧紧插入 USB 端口。

(3) 充电完成时

- 检查 USB 设备以检验充电状态。
- 从插座中拨下电源线。（图 16）
- 用橡胶盖盖住 USB 端口。



图 14



图 15

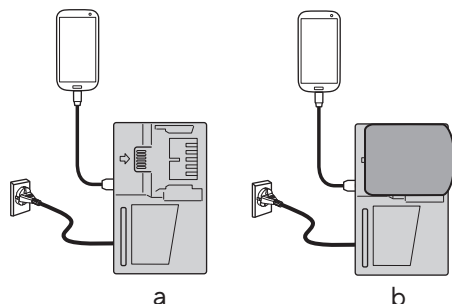

图 16

维护和检查

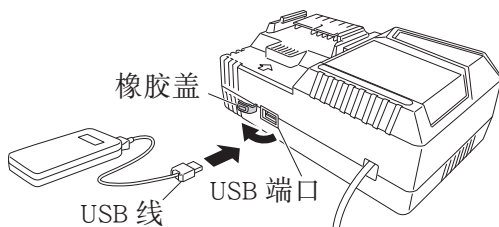
警告！

为避免发生严重事故，请确保开关处于关断位置，并取出电池。

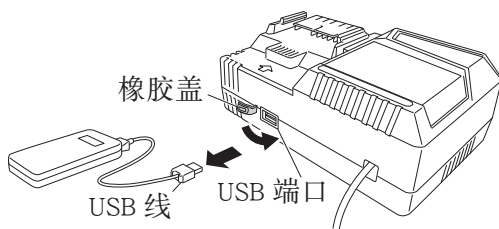
1. 检查安装螺钉

要经常检查安装螺钉是否紧固妥善。若发现螺钉松了，应立即重新扭紧，否则会导致严重的事故。

2. 电动机的维护

电动机绕线是电动工具的“心脏部”应仔细检查有无损伤，是否被油液或水沾湿。

3. 检查端子（工具和电池）

确保端子上没有堆积削屑和灰尘。

在操作前、操作时和操作后需要时常检查。

注意！

请清除端子上的削屑或灰尘。

否则可能导致故障。

4. 清理外部

当充电式吹风机脏污时，请用柔软的干布或沾有肥皂水的布片擦拭。请勿使用氯溶剂、汽油或油漆稀释剂，以免塑料溶化。

5. 电力耗尽的电池的处理方法

警告！

请勿将电力耗尽的电池丢弃。如果焚烧电池，可能会引起爆炸。该电池可回收利用。根据各国家和地区的法令法规，将电力耗尽的电池丢弃到城市垃圾中属于违法行为。请向当地的固体废弃物负责人员咨询具体回收事宜或妥善的处理方法。

6. 收藏

请将充电式吹风机和电池保管在温度低于 40°C、小孩拿不到的地方。

注：

存放锂离子电池

在存放前请确保电池已完全充电。

电池在低电量的状态下长时间存放（3 个月或更长），可能会导致电池性能劣化，使用时间明显减少或无法进行充电。

但是，即使是使用时间明显减少的电池，通过反复充电和使用 2 ~ 5 次，有时也可恢复使用时间。

若反复充电和使用后电池的使用时间仍非常短，请认作为电池已达到了使用寿命并更换新的电池。

注意！

在操作和维修电动工具时，必须遵守贵国制定的安全的有关规则和标准。

关于 HiKOKI 牌无线电动工具的重要通知：

请确保始终使用我们指定的正版电池。如果使用我们指定以外的电池，或对电池进行拆卸和改动（例如拆卸和更换电池组件或其他内部部件），那么我们无法保证我们无线电动工具的安全性和使用性能。

故障排除

如果工具操作不正常，请使用下表中的检查步骤。如果未能解决问题，请向经销商或 HiKOKI 公司授权服务中心咨询。

1. 电动工具

| 现象 | 可能的原因 | 解决办法 |
|--------|--------------------|------------------------|
| 工具无法运行 | 没有剩余电池电量 | 为电池充电 |
| 工具突然停止 | 电池过热。 | 让电池冷却。 |
| 进气不足 | 集尘袋已满。 | 倒出灰尘。 |
| | 喷嘴堵塞。 | 清除堵塞物。 |
| | 喷嘴破裂或损坏。 | 请更换新装置。 |
| 无法安装电池 | 请尝试安装该工具指定的其他正版电池。 | 请安装多伏电池或 BSL18xx 系列电池。 |

2. 充电器

| 现象 | 可能的原因 | 解决办法 |
|----------------------|-----------------|---|
| 充电指示灯快速闪烁紫色，电池未开始充电。 | 电池未完全插入。 | 请紧紧插入电池。 |
| | 电池端部或电池的连接处有异物。 | 将异物清除。 |
| 充电指示灯闪烁红色，电池未开始充电。 | 电池未完全插入。 | 请紧紧插入电池。 |
| | 电池过热。 | 如果继续放置，电池将在温度降低后自动开始充电，但此种情况可能会缩短电池使用寿命。建议将电池放置在通风良好的位置，在充电前避免阳光直射。 |

| 现象 | 可能的原因 | 解决办法 |
|---------------------------------|----------------------------------|---|
| 即使电池完全充电，电池的使用寿命也会逐渐缩短。 | 电池的使用寿命已耗尽。 | 请更换新电池。 |
| 电池的充电时间较长。 | 电池、充电器或周围环境的温度过低。 | 请在室内或温暖的环境中充电。 |
| | 充电器的排气孔堵塞，导致其内部部件过热。 | 请勿堵塞排气孔。 |
| | 冷却扇未运转。 | 请联系 HiKOKI 授权服务中心进行维修。 |
| USB 电源灯熄灭，USB 设备停止充电。 | 电池剩余电量低。 | 用电量充足电池替换它。 |
| | | 将充电器的电源插头插入电插座中。 |
| 即使 USB 设备充电完毕，USB 电源灯也不熄灭。 | USB 电源灯点亮呈绿色，提示可进行 USB 充电。 | 这种情况不属于故障。 |
| 不清楚 USB 设备的充电状态如何或者是否充电完毕。 | 即使充电完毕，USB 电源灯也不熄灭。 | 检查正在充电的 USB 设备以确定其充电状态。 |
| USB 设备在中途暂停充电。 | 使用电池作为电源对 USB 设备进行充电时，充电器插入电插座。 | 这种情况不属于故障。充电器与电源间存在差异时，USB 将暂停充电约 5 秒钟。 |
| | 使用电源插座作为电源对 USB 设备进行充电时，电池插入充电器。 | |
| 电池和 USB 设备同时充电时，USB 设备将在中途暂停充电。 | 电池已完全充电。 | 这种情况不属于故障。检查电池是否已充电完成时，充电器将暂停 USB 充电约 5 秒钟。 |
| 电池和 USB 设备同时充电时，USB 设备将无法开始充电。 | 电池剩余电量已不足。 | 这种情况不属于故障。电池电量达到一定程度时，USB 将自动开始充电。 |

选择附件

根据特定作业选择适合的附件。
有关详细信息请联系 HiKOKI 授权服务中心。



产品编号：323582

喷嘴



产品编号：317124

长喷嘴



产品编号：990046

喷嘴 (B)



产品编号：323588

软管套件



产品编号：323587

集尘袋

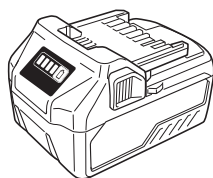

BSL36A18

电池

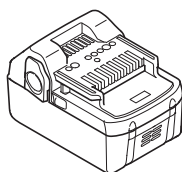

18V (Li-ion)

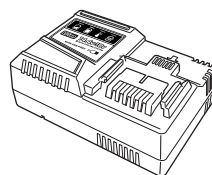

UC18YSL3
(14.4V - 18V)
充电器

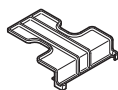

产品编号：329897

电池盖

CONTENTS

| | |
|--|----|
| GENERAL POWER TOOL SAFETY WARNINGS | 22 |
| CORDLESS BLOWER SAFETY WARNINGS | 25 |
| ADDITIONAL SAFETY WARNINGS | 27 |
| CAUTION ON LITHIUM-ION BATTERY | 28 |
| REGARDING LITHIUM-ION BATTERY TRANSPORTATION | 30 |
| USB DEVICE CONNECTION PRECAUTIONS | 30 |
| SYMBOLS | 30 |
| NAME OF PARTS..... | 31 |
| SPECIFICATIONS | 32 |
| STANDARD ACCESSORIES | 32 |
| APPLICATIONS..... | 33 |
| BATTERY REMOVAL/INSTALLATION | 33 |
| CHARGING | 33 |
| PRIOR TO OPERATION..... | 36 |
| MOUNTING AND DISMOUNTING THE NOZZLE AND DUST BAG | 37 |
| SWITCH AND AIR VOLUME CONTROL..... | 38 |
| HOW TO RECHARGE USB DEVICE | 39 |
| MAINTENANCE AND INSPECTION | 40 |
| TROUBLESHOOTING..... | 41 |
| SELECTING ACCESSORIES..... | 44 |

GENERAL POWER TOOL SAFETY WARNINGS

WARNING

Read all safety warnings, instructions, illustrations and specifications provided with this power tool.

Failure to follow all instructions listed below may result in electric shock, fire and/or serious injury.

Save all warnings and instructions for future reference.

The term “power tool” in the warnings refers to your mains-operated (corded) power tool or battery-operated (cordless) power tool.

- 1) **Work area safety**
 - a) **Keep work area clean and well lit.**
Cluttered or dark areas invite accidents.
 - b) **Do not operate power tools in explosive atmospheres, such as in the presence of flammable liquids, gases or dust.**
Power tools create sparks which may ignite the dust or fumes.
 - c) **Keep children and bystanders away while operating a power tool.**
Distractions can cause you to lose control.

2) Electrical safety

- a) **Power tool plugs must match the outlet.**
Never modify the plug in any way.
Do not use any adapter plugs with earthed (grounded) power tools.
Unmodified plugs and matching outlets will reduce risk of electric shock.
- b) **Avoid body contact with earthed or grounded surfaces, such as pipes, radiators, ranges and refrigerators.**
There is an increased risk of electric shock if your body is earthed or grounded.
- c) **Do not expose power tools to rain or wet conditions.**
Water entering a power tool will increase the risk of electric shock.
- d) **Do not abuse the cord. Never use the cord for carrying, pulling or unplugging the power tool.**
Keep cord away from heat, oil, sharp edges or moving parts.
Damaged or entangled cords increase the risk of electric shock.
- e) **When operating a power tool outdoors, use an extension cord suitable for outdoor use.**
Use of a cord suitable for outdoor use reduces the risk of electric shock.
- f) **If operating a power tool in a damp location is unavoidable, use a residual current device (RCD) protected supply.**
Use of an RCD reduces the risk of electric shock.

3) Personal safety

- a) **Stay alert, watch what you are doing and use common sense when operating a power tool.**
Do not use a power tool while you are tired or under the influence of drugs, alcohol or medication.
A moment of inattention while operating power tools may result in serious personal injury.
- b) **Use personal protective equipment. Always wear eye protection.**
Protective equipment such as a dust mask, non-skid safety shoes, hard hat or hearing protection used for appropriate conditions will reduce personal injuries.
- c) **Prevent unintentional starting. Ensure the switch is in the off-position before connecting to power source and/or battery pack, picking up or carrying the tool.**
Carrying power tools with your finger on the switch or energising power tools that have the switch on invites accidents.
- d) **Remove any adjusting key or wrench before turning the power tool on.**
A wrench or a key left attached to a rotating part of the power tool may result in personal injury.
- e) **Do not overreach. Keep proper footing and balance at all times.**
This enables better control of the power tool in unexpected situations.
- f) **Dress properly. Do not wear loose clothing or jewellery. Keep your hair, clothing and gloves away from moving parts.**
Loose clothes, jewellery or long hair can be caught in moving parts.

English

- g) **If devices are provided for the connection of dust extraction and collection facilities, ensure these are connected and properly used.**

Use of dust collection can reduce dust-related hazards.

- h) **Do not let familiarity gained from frequent use of tools allow you to become complacent and ignore tool safety principles.**

A careless action can cause severe injury within a fraction of a second.

4) **Power tool use and care**

- a) **Do not force the power tool. Use the correct power tool for your application.**

The correct power tool will do the job better and safer at the rate for which it was designed.

- b) **Do not use the power tool if the switch does not turn it on and off.**

Any power tool that cannot be controlled with the switch is dangerous and must be repaired.

- c) **Disconnect the plug from the power source and/or remove the battery pack, if detachable, from the power tool before making any adjustments, changing accessories, or storing power tools.**

Such preventive safety measures reduce the risk of starting the power tool accidentally.

- d) **Store idle power tools out of the reach of children and do not allow persons unfamiliar with the power tool or these instructions to operate the power tool.**

Power tools are dangerous in the hands of untrained users.

- e) **Maintain power tools and accessories. Check for misalignment or binding of moving parts, breakage of parts and any other condition that may affect the power tool's operation.**

If damaged, have the power tool repaired before use.

Many accidents are caused by poorly maintained power tools.

- f) **Keep cutting tools sharp and clean.**

Properly maintained cutting tools with sharp cutting edges are less likely to bind and are easier to control.

- g) **Use the power tool, accessories and tool bits etc. in accordance with these instructions, taking into account the working conditions and the work to be performed.**

Use of the power tool for operations different from those intended could result in a hazardous situation.

- h) **Keep handles and grasping surfaces dry, clean and free from oil and grease.**

Slippery handles and grasping surfaces do not allow for safe handling and control of the tool in unexpected situations.

5) **Battery tool use and care**

- a) **Recharge only with the charger specified by the manufacturer.**

A charger that is suitable for one type of battery pack may create a risk of fire when used with another battery pack.

- b) **Use power tools only with specifically designated battery packs.**

Use of any other battery packs may create a risk of injury and fire.

- c) **When battery pack is not in use, keep it away from other metal objects, like paper clips, coins, keys, nails, screws or other small metal objects, that can make a connection from one terminal to another.**
Shorting the battery terminals together may cause burns or a fire.
- d) **Under abusive conditions, liquid may be ejected from the battery; avoid contact. If contact accidentally occurs, flush with water. If liquid contacts eyes, additionally seek medical help.**
Liquid ejected from the battery may cause irritation or burns.
- e) **Do not use a battery pack or tool that is damaged or modified.**
Damaged or modified batteries may exhibit unpredictable behaviour resulting in fire, explosion or risk of injury.
- f) **Do not expose a battery pack or tool to fire or excessive temperature.**
Exposure to fire or temperature above 130 °C may cause explosion.
- g) **Follow all charging instructions and do not charge the battery pack or tool outside the temperature range specified in the instructions.**
Charging improperly or at temperatures outside the specified range may damage the battery and increase the risk of fire.

6) Service

- a) **Have your power tool serviced by a qualified repair person using only identical replacement parts.**
This will ensure that the safety of the power tool is maintained.
- b) **Never service damaged battery packs.**
Service of battery packs should only be performed by the manufacturer or authorized service providers.

CAUTION

Keep children and infirm persons away.

When not in use, tools should be stored out of reach of children and infirm persons.

CORDLESS BLOWER SAFETY WARNINGS

1. Do not put your hands or face near the cordless blower's blast port or suction port during use.
Doing so might lead to injuries.
2. When cleaning electrical conductors such as an electrical panel, be sure there is plenty of space between the conductor and the power tool. Also, make sure to mount the nozzle when cleaning.
Failure to mount the nozzle while cleaning the conductor can result in an electric shock.
3. Do not block the blast port and/or suction port. Also, do not allow dust to accumulate in the suction port.
Blocking the blast port or suction port will abnormally speed up the motor's rotation which may damage the fan within the power tool and cause the motor to excessively heat up.
4. Do not use the power tool to fill a balloon or swim ring with air.

English

5. Do not use in locations where inflammable materials such as lacquer, paint, benzene, thinner or gasoline are present. Also do not let items such as lighted cigarette butts be suctioned inside at such locations.
Explosion or fires might result.
6. Do not use near objects generating high heat such as stoves; do not blow at lit cigarette butts; and do not stoke or extinguish flames.
Fires might occur if used near such locations.
7. Do not use in environments subject to heavy doses of chemicals, etc.
Plastic sections might weaken and break, and injuries might occur.
8. If you notice that the unit is generating unusually high temperatures, operating poorly, or making abnormal noises, immediately stop using and shut off the power switch. Request an inspection and repair from the dealer where you purchased the unit or a HiKOKI Authorized Service Center.
Continuing to use while operating abnormally might cause injuries.
9. If the unit is mistakenly dropped or strikes another object, make a thorough check of the unit for cracks, breakage or deformation, etc.
Injuries might occur if the unit has cracks, breakage or deformation.
10. Do not place objects such as screws inside the suction port or blast port.
Failure to do so may damage the interior parts of the tool.
11. For blowing operation, mount the nozzle to the blast port. For dust collection, mount the nozzle to the suction port and mount the dust bag on the blast port.
12. Do not use the tool to suction liquid such as water or wet dust particles, or items such as bits of glass, cutting tools, nails, screws, pebbles, or lit cigarette butts.
13. Do not use industrial oil or grease (cutting oil, lubricant, etc.), or in the vicinity of chemicals.
Doing so may cause parts to deteriorate or cause damage.
14. Make a thorough inspection if using the cordless blower to blow or clean viscous powder or dust particles.
Powder or dust particles might be suctioned in and adhere internally, causing the vanes to break or injuries to occur.
15. Never touch moving parts.
Never place your hands, fingers or other body parts near the tool's moving parts.
16. NEVER leave tool running unattended. Turn power off.
Don't leave tool until it comes to a complete stop.
17. When operating the tool in high locations, make sure there is nobody below.
18. Be careful when blowing large amounts of fine dust in a dry environment as it can cause an accumulation of static electricity which can result in an unexpected electric discharge.
19. Never point toward people or animals. The machine blows small objects at a high velocity and can cause injury.
20. Never operate from an unstable footing, such as when on a ladder or step ladder.
Doing so may cause an injury.
21. Do not strike the tool with other objects; avoid strong impacts such as dropping the tool; and do not allow the tool to get wet.
Any one of these can damage the built-in precision parts and result in malfunction.
22. Before operation, remove any objects in the area that may cause injury or accident.

23. Do not peep into the blast port during operation.
24. Keep the suction port away from your body to avoid sucking in your work clothes.
25. If any foreign material enters the suction port and stops the blast of air, immediately switch off the tool, remove the battery and then extract the foreign material.
26. Precautions during transport
 - Release the switch on the body of the machine and remove the battery.
 - Carry the machine by the handle on its body.
 - When transporting it via vehicle, take appropriate steps to prevent it from falling over or being damaged.

ADDITIONAL SAFETY WARNINGS

1. **Always charge the battery at a temperature of 0–40°C.**
A temperature of less than 0°C will result in over charging which is dangerous. The battery cannot be charged at a temperature greater than 40°C.
The most suitable temperature for charging is that of 20–25°C.
2. **Do not use the charger continuously.**
When one charging is completed, leave the charger for about 15 minutes before the next charging of battery.
3. **Do not allow foreign matter to enter the hole for connecting the rechargeable battery.**
4. **Never disassemble the rechargeable battery and charger.**
5. **Never short-circuit the rechargeable battery.** Shortcircuiting the battery will cause a great electric current and overheat. It results in burn or damage to the battery.
6. **Do not dispose of the battery in fire.** If the battery is burnt, it may explode.
7. **Bring the battery to the shop from which it was purchased as soon as the post-charging battery life becomes too short for practical use.** Do not dispose of the exhausted battery.
8. **Do not insert object into the air ventilation slots of the charger.** Inserting metal objects or inflammables into the charger air ventilation slots will result in electrical shock hazard or damaged charger.
9. **When using this unit continuously, the unit may overheat, leading to damage in the motor and switch.** Therefore, whenever the housing becomes hot, give the tool a break for a while.
10. **Make sure that the battery is installed firmly.** If it is at all loose it could come off and cause an accident.
11. **Do not use the product if the tool or the battery terminals (battery mount) are deformed.**
Installing the battery could cause a short circuit that could result in smoke emission or ignition.
12. **Keep the tool's terminals (battery mount) free of swarf and dust.**
 - Prior to use, make sure that swarf and dust have not collected in the area of the terminals.
 - During use, try to avoid swarf or dust on the tool from falling on the battery.

English

- When suspending operation or after use, do not leave the tool in an area where it may be exposed to falling swarf or dust.
Doing so could cause a short circuit that could result in smoke emission or ignition.
- 13. Always use the tool and battery at temperatures between -5°C and 40°C.

CAUTION ON LITHIUM-ION BATTERY

To extend the lifetime, the lithium-ion battery equips with the protection function to stop the output.

In the cases of 1 to 3 described below, when using this product, even if you are pulling the switch, the motor may stop. This is not the trouble but the result of protection function.

1. When the battery power remaining runs out, the motor stops.
In such case, charge it up immediately.
2. If the tool is overloaded, the motor may stop. In this case, release the switch of tool and eliminate causes of overloading. After that, you can use it again.
3. If the battery is overheated under overload work, the battery power may stop.
In this case, stop using the battery and let the battery cool. After that, you can use it again.

Furthermore, please heed the following warning and caution.

WARNING

In order to prevent any battery leakage, heat generation, smoke emission, explosion and ignition beforehand, please be sure to heed the following precautions.

1. Make sure that swarf and dust do not collect on the battery.
 - During work make sure that swarf and dust do not fall on the battery.
 - Make sure that any swarf and dust falling on the power tool during work do not collect on the battery.
 - Do not store an unused battery in a location exposed to swarf and dust.
 - Before storing a battery, remove any swarf and dust that may adhere to it and do not store it together with metal parts (screws, nails, etc.).
2. Do not pierce battery with a sharp object such as a nail, strike with a hammer, step on, throw or subject the battery to severe physical shock.
3. Do not use an apparently damaged or deformed battery.
4. Do not use the battery in reverse polarity.
5. Do not connect directly to an electrical outlets or car cigarette lighter sockets.
6. Do not use the battery for a purpose other than those specified.
7. If the battery charging fails to complete even when a specified recharging time has elapsed, immediately stop further recharging.
8. Do not put or subject the battery to high temperatures or high pressure such as into a microwave oven, dryer, or high pressure container.
9. Keep away from fire immediately when leakage or foul odor are detected.
10. Do not use in a location where strong static electricity generates.

11. If there is battery leakage, foul odor, heat generated, discolored or deformed, or in any way appears abnormal during use, recharging or storage, immediately remove it from the equipment or battery charger, and stop use.
12. Do not immerse the battery or allow any fluids to flow inside. Conductive liquid ingress, such as water, can cause damage resulting in fire or explosion. Store your battery in a cool, dry place, away from combustible and flammable items. Corrosive gas atmospheres must be avoided.

CAUTION

1. If liquid leaking from the battery gets into your eyes, do not rub your eyes and wash them well with fresh clean water such as tap water and contact a doctor immediately.
If left untreated, the liquid may cause eye-problems.
2. If liquid leaks onto your skin or clothes, wash well with clean water such as tap water immediately.
There is a possibility that this can cause skin irritation.
3. If you find rust, foul odor, overheating, discolor, deformation, and/or other irregularities when using the battery for the first time, do not use and return it to your supplier or vendor.

WARNING

If an electrically conductive foreign object enters the terminals of the lithium ion battery, a short-circuit may occur resulting in the risk of fire. Please observe the following matters when storing the battery.

- Do not place electrically conductive cuttings, nails, steel wire, copper wire or other wire in the storage case.
- Either install the battery in the power tool or store by securely pressing into the battery cover until the ventilation holes are concealed to prevent short-circuits (See Fig. 1).

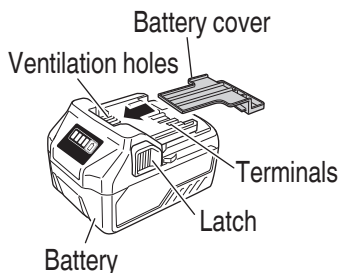

Fig. 1

REGARDING LITHIUM-ION BATTERY TRANSPORTATION

When transporting a lithium-ion battery, please observe the following precautions.

WARNING

Notify the transporting company that a package contains a lithium-ion battery, inform the company of its power output and follow the instructions of the transportation company when arranging transport.

- Lithium-ion batteries that exceed a power output of 100 Wh are considered to be in the freight classification of Dangerous Goods and will require special application procedures.
- For transportation abroad, you must comply with international law and the rules and regulations of the destination country.

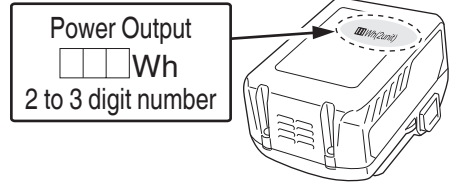

Fig. 2

USB DEVICE CONNECTION PRECAUTIONS



When an unexpected problem occurs, the data in a USB device connected to this product may be corrupted or lost. Always make sure to back up any data contained in the USB device prior to use with this product.

Please be aware that our company accepts absolutely no responsibility for any data stored in a USB device that is corrupted or lost, nor for any damage that may occur to a connected device.

SYMBOLS

WARNING

The following show symbols used for the machine. Be sure that you understand their meaning before use.

| | | | |
|--|--|---|------------------------|
|  | To reduce the risk of injury, user must read instruction manual. | n_0 | No-load speed |
|  | Direct current | /min | Oscillation per minute |
| V | Rated voltage |  | Warning |

NAME OF PARTS

1. POWER TOOL

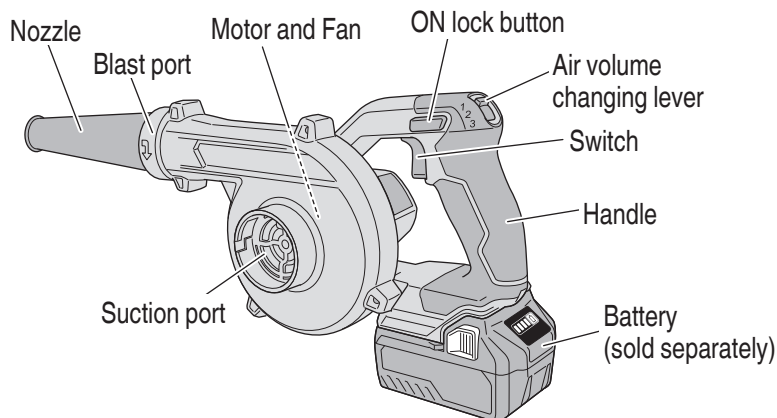

Fig. 3

2. Battery (optional accessories)

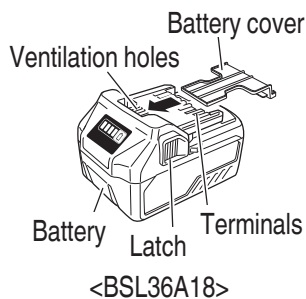

Fig. 4

3. Battery Charger (optional accessories)

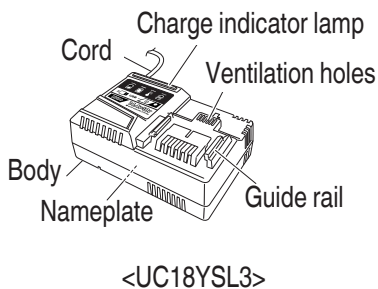

Fig. 5

SPECIFICATIONS

POWER TOOL

| | | |
|-----------------------------|--|----------|
| Model | RB18DC | |
| Voltage | 18 V | |
| No-Load Speed*1 | 0–20000 /min | |
| Air velocity | Maximum*2 | 0–95 m/s |
| | Average*2 | 0–78 m/s |
| Air volume*3 | 0–3.5 m ³ /min | |
| Continuous operating time*4 | 3: Approximately 20 minutes 2: Approximately 55 minutes 1: Approximately 130 minutes | |
| Battery*5 | BSL36A18: Li-ion 36 V / 18 V (2.5 Ah / 5.0 Ah 10 cells) | |
| Weight | 1.8 kg (BSL36A18 attached) | |

*1 BSL36A18, when fully charged

*2 With nozzle

*3 Without nozzle

*4 For guidance purposes only. Results will differ according to situations such as operating environment and battery condition.

*5 Existing batteries (BSL3660/3626/3620) cannot be used with this tool.

Charger (Sold separately)

| | |
|------------------|-----------|
| Model | UC18YSL3 |
| Charging voltage | 14.4–18 V |
| Weight | 0.6 kg |

STANDARD ACCESSORIES

In addition to the main unit (1 unit), the package contains the accessories listed in the below.

Table 1

| | | |
|--|--|----------------|
| | | RB18DC (NN) |
| Nozzle  | | 1 |

APPLICATIONS

- Cleaning facilities and equipment in lumber mills, cigarette-making plants, spinning mills, etc.
- Cleaning devices and equipment in repair shops.
- Blowing operation.

BATTERY REMOVAL/INSTALLATION

1. Battery removal

Hold the handle tightly and push the battery latches (2 pcs.) to remove the battery (Fig. 6).

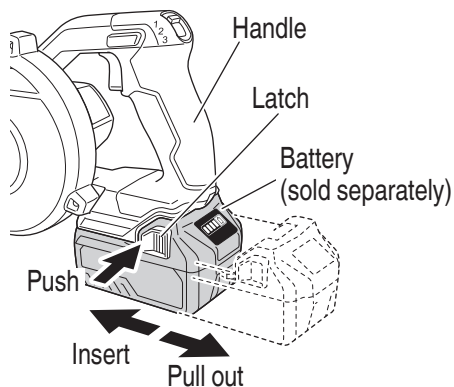

Fig. 6

CAUTION

Never short-circuit the battery.

2. Battery installation

Insert the battery while observing its polarities (Fig. 6).

CHARGING

Before using the power tool, charge the battery as follows.

1. Connect the charger's power cord to the receptacle.

When connecting the plug of the charger to a receptacle, the pilot lamp will blink in red (At 1- second intervals).

2. Insert the battery into the charger.

Firmly insert the battery into the charger as shown in Fig. 7.

3. Charging

When inserting a battery in the charger, the charge indicator lamp will blink in blue.

When the battery becomes fully recharged, the charge indicator lamp will light up in green. (See Table 2 on page 34)

(1) Charge indicator lamp indication

The indications of the charge indicator lamp will be as shown in Table 2 on page 34, according to the condition of the charger or the rechargeable battery.

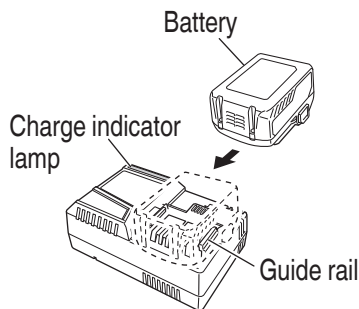





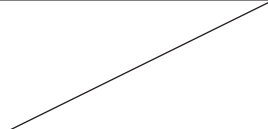



Fig. 7

Table 2

| Indications of the charge indicator lamp | | | | |
|---|---------------------|-------------------|--|--|
| Charge indicator lamp (RED / BLUE / GREEN / PURPLE) | Before charging | Blinks (RED) | Lights for 0.5 seconds. Does not light for 0.5 seconds. (off for 0.5 seconds)  | Plugged into power source |
| | While charging | Blinks (BLUE) | Lights for 0.5 seconds. Does not light for 1 second. (off for 1 second)  | Battery capacity at less than 50% |
| | | Blinks (BLUE) | Lights for 1 second. Does not light for 0.5 seconds. (off for 0.5 seconds)  | Battery capacity at less than 80% |
| | | Lights (BLUE) | Lights continuously  | Battery capacity at more than 80% |
| | Charging complete | Lights (GREEN) | Lights continuously  (Continuous buzzer sound: about 6 seconds) |  |
| | Overheat standby | Blinks (RED) | Lights for 0.3 seconds. Does not light for 0.3 seconds. (off for 0.3 seconds)  | Battery overheated. Unable to charge. (Charging will commence when battery cools) |
| | Charging impossible | Flickers (PURPLE) | Lights for 0.1 seconds. Does not light for 0.1 seconds. (off for 0.1 seconds)  (Intermittent buzzer sound: about 2 seconds) | Malfunction in the battery or the charger |

- (2) Regarding the temperatures and charging time of the rechargeable battery
The temperatures and charging time will become as shown in **Table 3**.

Table 3

| Charger | | UC18YSL3 | | | | | |
|---------|--|--|--|--|--|--|-------------------|
| Battery | Type of battery | Li-ion | | | | | |
| | Temperatures at which the battery can be recharged | 0°C–50°C | | | | | |
| | Charging voltage | V | 14.4 | | 18 | | |
| | Charging time, approx. (At 20°C) | min | BSL14xx series | | BSL18xx series | | Multi volt series |
| | | | (4 cells) | (8 cells) | (5 cells) | (10 cells) | (10 cells) |
| | | BSL1415S: 15 BSL1415 : 15 BSL1415X: 15 BSL1420 : 20 BSL1425 : 25 BSL1430C: 30 | BSL1430 : 20 BSL1440 : 26 BSL1450 : 32 BSL1460 : 38 | BSL1815S: 15 BSL1815 : 15 BSL1815X: 15 BSL1820 : 20 BSL1825 : 25 BSL1830C: 30 BSL1850C: 32 | BSL1830 : 20 BSL1840 : 26 BSL1850 : 32 BSL1860 : 38 | BSL36A18: 32 BSL36B18: 52 BSL36C18: 20 | |
| USB | Charging voltage | V | 5 | | | | |
| | Charging current | A | 2 | | | | |

NOTE

The recharging time may vary according to the ambient temperature and power source voltage.

4. Disconnect the charger's power cord from the receptacle.

5. Hold the charger firmly and pull out the battery.

NOTE

Be sure to pull out the battery from the charger after use, and then keep it.

| |
|--|
| Regarding electric discharge in case of new batteries, etc. |
|--|

As the internal chemical substance of new batteries and batteries that have not been used for an extended period is not activated, the electric discharge might be low when using them the first and second time. This is a temporary phenomenon, and normal time required for recharging will be restored by recharging the batteries 2–3 times.

English

How to make the batteries perform longer.

- (1) Recharge the batteries before they become completely exhausted.
When you feel that the power of the tool becomes weaker, stop using the tool and recharge its battery. If you continue to use the tool and exhaust the electric current, the battery may be damaged and its life will become shorter.
- (2) Avoid recharging at high temperatures.
A rechargeable battery will be hot immediately after use. If such a battery is recharged immediately after use, its internal chemical substance will deteriorate, and the battery life will be shortened. Leave the battery and recharge it after it has cooled for a while.

CAUTION

- **If the battery is charged while it is heated because it has been left for a long time in a location subject to direct sunlight or because the battery has just been used, the charge indicator lamp of the charger lights for 0.3 seconds, does not light for 0.3 seconds (off for 0.3 seconds). In such a case, first let the battery cool, then start charging.**
- **When the charge indicator lamp flickers (at 0.2-second intervals), check for and take out any foreign objects in the charger's battery connector. If there are no foreign objects, it is probable that the battery or charger is malfunctioning. Take it to your authorized Service Center.**
- **Since the built-in micro computer takes about 3 seconds to confirm that the battery being charged with UC18YSL3 is taken out, wait for a minimum of 3 seconds before reinserting it to continue charging. If the battery is reinserted within 3 seconds, the battery may not be properly charged.**

PRIOR TO OPERATION

1. Setting up and checking the work environment
Check if the work environment is suitable by following the precautions.

2. About Remaining Battery Indicator
You can check the battery's remaining capacity by pressing the remaining battery indicator switch to light the indicator lamp.

(Fig. 8, Table 4)

The indicator will shut off approximately 3 seconds after the remaining battery indicator switch is pressed.

It is best to use the remaining battery indicator as a guide since there are slight differences such as ambient temperature and the condition of the battery.

Also, the remaining battery indicator may vary from those equipped to a tool or charger.

Remaining battery indicator lamp Remaining battery indicator switch

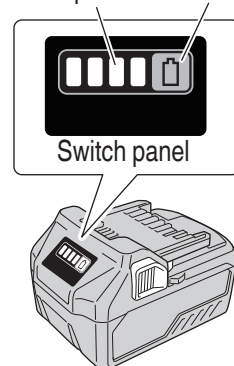
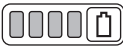





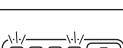

Fig. 8

Table 4

| State of lamp | Battery Remaining Power |
|---|---|
|  | Lights ; The battery remaining power is over 75% |
|  | Lights ; The battery remaining power is 50%–75%. |
|  | Lights ; The battery remaining power is 25%–50%. |
|  | Lights ; The battery remaining power is less than 25% |
|  | Blinks ; The battery remaining power is nearly empty. Recharge the battery soonest possible. |
|  | Blinks ; Output suspended due to high temperature. Remove the battery from the tool and allow it to fully cool down. |
|  | Blinks ; Output suspended due to failure or malfunction. The problem may be the battery so please contact your dealer. |

As the remaining battery indicator shows somewhat differently depending on ambient temperature and battery characteristics, read it as a reference.

NOTE

Do not give a strong shock to the switch panel or break it. It may lead to a trouble.

MOUNTING AND DISMOUNTING THE NOZZLE AND DUST BAG

WARNING

To avoid serious accident, ensure the switch is in the OFF position, and pull out the battery.

1. Mounting the Nozzle

Insert the pin located outside the nozzle into the groove provided on the blast port, and fully turn the nozzle toward the arrow in **Fig. 9** until a click is heard. To dismount the nozzle, follow the above procedures in reverse.

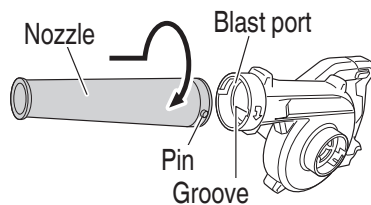

Fig. 9

NOTE

Before conducting a blowing operation, blow out air in a location where there is nobody nearby to make sure the tool is free of any residue.

English

2. When using the Cordless Blower for dust collection

- (1) Mounting the Dust Bag
Mount the dust bag on the blast port, following the same procedure described above for mounting of the nozzle (Fig. 10).
- (2) Mounting the Nozzle
Insert the pin located outside the nozzle into the groove provided on the suction port, and fully turn the nozzle toward the arrow in Fig. 11 until a click is heard.

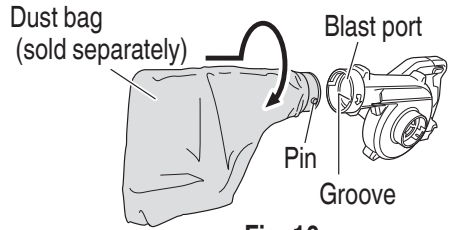

Fig. 10

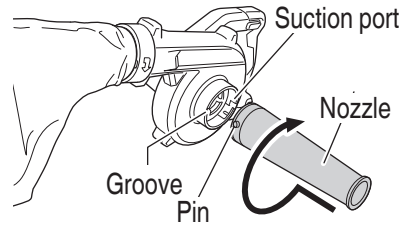

Fig. 11

SWITCH AND AIR VOLUME CONTROL

- Switch operation (Fig. 12).
When the switch is depressed, the blower rotates.
When the switch is released, the blower stops.
The volume can be adjusted for a variable amount depending on how much the switch is drawn in.
- Continuous operation (Fig. 12)
Draw the switch as far as it goes and press the ON lock button to lock in place the operating state of the tool for continuous operation.
The ON lock button can be activated by pressing either side of the switch.

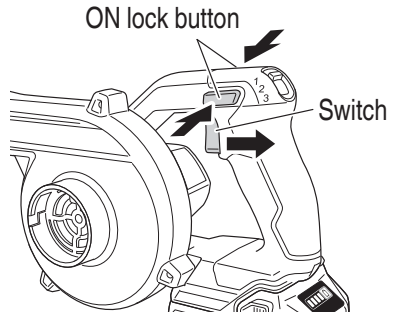

Fig. 12

To discontinue operation, draw the switch in once again to release the ON lock button.

- Air volume control function (Fig. 13)
When the switch is fully drawn, the air volume can be adjusted to High, Medium, or Low.

| Lever position | Air volume |
|----------------|------------|
| 3 | High |
| 2 | Medium |
| 1 | Low |

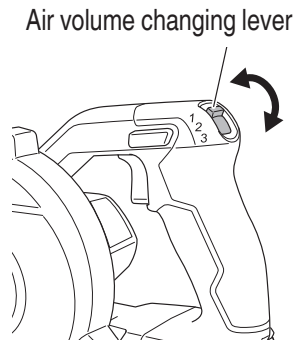

Fig. 13

NOTE

During operation, the unit can generate static electricity which may cause the motor to stop. This is a protective feature and not a malfunction. Draw the switch in once again to restart the motor.

HOW TO RECHARGE USB DEVICE**WARNING**

- Prior to use, check the connecting USB cable for any defect or damage. Using a defective or damaged USB cable can cause smoke emission or ignition.
- When the product is not being used, cover the USB port with the rubber cover. Buildup of dust etc. in the USB port can cause smoke emission or ignition.

NOTE

- There may be an occasional pause during USB recharging.
- When a USB device is not being charged, remove the USB device from the charger. Failure to do so may not only reduce the battery life of a USB device, but may also result in unexpected accidents.
- It may not be possible to charge some USB devices, depending on the type of device.

- (1) Select a charging method
Depending on the charge method selected, either the battery is inserted into the charger or the power cord is plugged into an outlet.

- Charging a USB device from a electrical outlet. (Fig. 14-a)

- Charging a USB device and battery from a electrical outlet. (Fig. 14-b)

- (2) Connect the USB cable. (Fig. 15)
Pull back the rubber cover and firmly plug in a commercially available USB cable (appropriate to the device being charged) into the USB port.

- (3) When charging is completed
 - To verify charge status, check the USB device.

- Unplug the power cord from the electrical outlet. (Fig. 16)

- Place the rubber cover over the USB port.

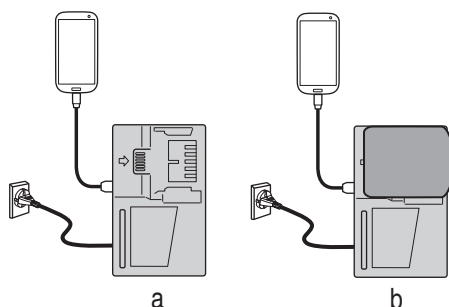
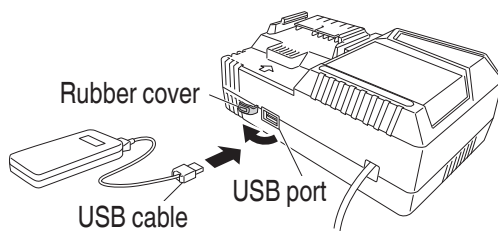
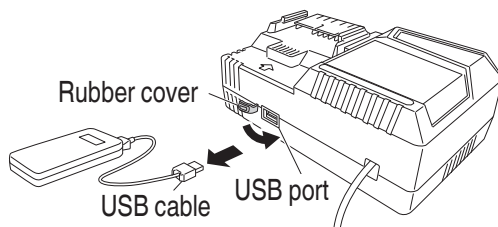
**Fig. 14****Fig. 15****Fig. 16**

MAINTENANCE AND INSPECTION

WARNING

To avoid serious accident, ensure the switch is in the OFF position, and pull out the battery.

1. Inspecting the mounting screws

Regularly inspect all mounting screws and ensure that they are properly tightened. Should any of the screws be loose, retighten them immediately. Failure to do so could result in serious hazard.

2. Maintenance of the motor

The motor unit winding is the very "heart" of the power tool.

Exercise due care to ensure the winding does not become damaged and/or wet with oil or water.

3. Inspection of terminals (tool and battery)

Check to make sure that swarf and dust have not collected on the terminals.

On occasion check prior, during and after operation.

CAUTION

Remove any swarf or dust which may have collected on the terminals.

Failure to do so may result in malfunction.

4. Cleaning of the outside

When the cordless blower is stained, wipe with a soft dry cloth or a cloth moistened with soapy water. Do not use chloric solvents, gasoline or paint thinner, for they melt plastics.

5. Disposal of the exhausted battery

WARNING

Do not dispose of the exhausted battery. The battery may explode if it is incinerated. The battery is recyclable. At the end of its useful life, under various state and local laws, it may be illegal to dispose of this battery into the municipal waste stream. Check with your local solid waste officials for details in your area for recycling options or proper disposal.

6. Storage

Store the cordless blower and the battery in a place in which the temperature is less than 40°C and out of reach of children.

NOTE

Storing Lithium-ion Batteries

Make sure the batteries have been fully charged before storing them.

Prolonged storage (3 months or more) of batteries with a low charge may result in performance deterioration, significantly reducing battery usage time or rendering the batteries incapable of holding a charge.

However, significantly reduced battery usage time may be recovered by repeatedly charging and using the batteries two to five times.

If the battery usage time is extremely short despite repeated charging and use, consider the batteries dead and purchase new batteries.

CAUTION

In the operation and maintenance of power tools, the safety regulations and standards prescribed in each country must be observed.

Important notice on the batteries for the HiKOKI cordless power tools

Please always use one of our designated genuine batteries. We cannot guarantee the safety and performance of our cordless power tool when used with batteries other than these designated by us, or when the battery is disassembled and modified (such as disassembly and replacement of cells or other internal parts).

TROUBLESHOOTING

Use the inspections in the table below if the tool does not operate normally. If this does not remedy the problem, consult your dealer or the HiKOKI Authorized Service Center.

1. Power tool

| Symptom | Possible cause | Remedy |
|-----------------------------|---|---|
| Tool doesn't run | No remaining battery power | Charge the battery. |
| Tool suddenly stopped | The battery is overheated. | Let the battery cool down. |
| Poor suction | Dust bag is full. | Dispose the dust. |
| | Nozzle is plugged. | Remove the obstruction. |
| | Nozzle is cracked or damaged. | Exchange the unit with a new one. |
| Battery cannot be installed | Attempting to install a battery other than that specified for the tool. | Please install batteries that are multi volt or BSL18xx series. |

English

2. Charger

| Symptom | Possible cause | Remedy |
|--|---|---|
| The charge indicator lamp rapidly flickers purple, and battery charging doesn't begin. | The battery is not inserted all the way. | Insert the battery firmly. |
| | There is foreign matter in the battery terminal or where the battery is attached. | Remove the foreign matter. |
| The charge indicator lamp blinks red, and battery charging doesn't begin. | The battery is not inserted all the way. | Insert the battery firmly. |
| | The battery is overheated. | If left alone, the battery will automatically begin charging if its temperature decreases, but this may reduce battery life. It is recommended that the battery be cooled in a well-ventilated location away from direct sunlight before charging it. |
| Battery usage time is short even though the battery is fully charged. | The battery's life is depleted. | Replace the battery with a new one. |
| The battery takes a long time to charge. | The temperature of the battery, the charger, or the surrounding environment is extremely low. | Charge the battery indoors or in another warmer environment. |
| | The charger's vents are blocked, causing its internal components to overheat. | Avoid blocking the vents. |
| | The cooling fan is not running. | Contact a HiKOKI Authorized Service Center for repairs. |
| The USB power lamp has switched off and the USB device has stopped charging. | The battery's capacity has become low. | Replace the battery with one that has capacity remaining. |
| | | Plug the charger's power plug into an electric socket. |
| USB power lamp does not switch off even though the USB device has finished charging. | The USB power lamp lights up green to indicate that USB charging is possible. | This is not a malfunction. |

| Symptom | Possible cause | Remedy |
|--|---|---|
| It is unclear what the charging status of a USB device is, or whether its charging is complete. | The USB power lamp does not switch off even when charging is complete. | Examine the USB device that is charging to confirm its charging status. |
| Charging of a USB device pauses midway. | The charger was plugged into an electrical socket while the USB device was being charged using the battery as the power source. | This is not a malfunction. The charger pauses USB charging for about 5 seconds when it is differentiating between power sources. |
| | A battery was inserted into the charger while the USB device was being charged using a power socket as the power source. | |
| Charging of the USB device pauses midway when the battery and the USB device are being charged at the same time. | The battery has become fully charged. | This is not a malfunction. The charger pauses USB charging for about 5 seconds while it checks whether the battery has successfully completed charging. |
| Charging of the USB device doesn't start when the battery and the USB device are being charged at the same time. | The remaining battery capacity is extremely low. | This is not a malfunction. When the battery capacity reaches a certain level, USB charging automatically begins. |

SELECTING ACCESSORIES

Select accessories that are suited to a specific task.
For details contact HiKOKI Authorized Service Center.



Part Number: 323582
Nozzle

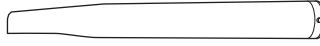

Part Number: 317124
Long Nozzle



Part Number: 990046
Nozzle(B)



Part Number: 323588
Hose set



Part Number: 323587
Dust bag

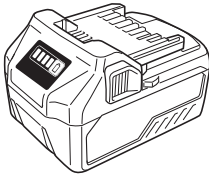

BSL36A18

Battery

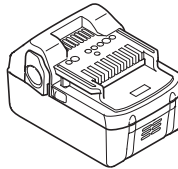

18 V (Li-ion)

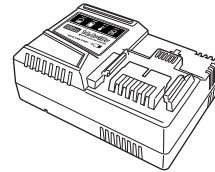

UC18YSL3
(14.4 V-18 V)
Charger

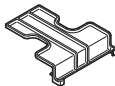

Part Number: 329897
Battery cover

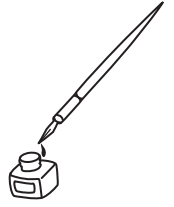

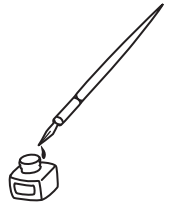

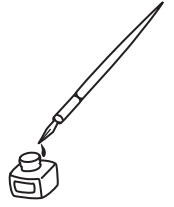

服务中心
高壹工机商业(上海)有限公司
上海市闵行区浦江工业园区三鲁路3585号7幢3楼

制造商
广东高壹工机有限公司
广东省广州市番禺区化龙镇工业路富裕围工业村

Koki Holdings Co., Ltd.

107
编号: C99742622 G
发行日期: 2021年 7月
中国印刷