

# HIKOKI

---

## RB 18DC

---

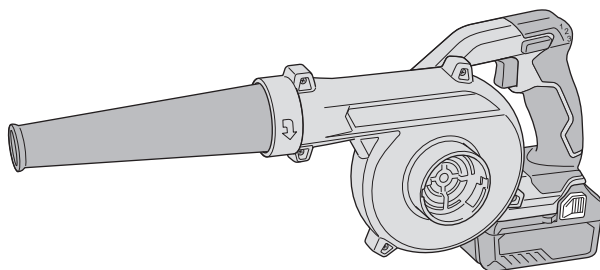

Handling instructions

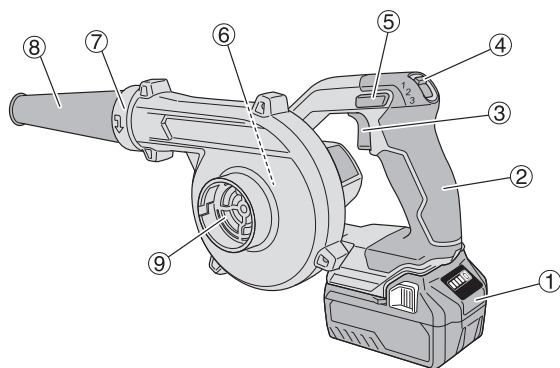
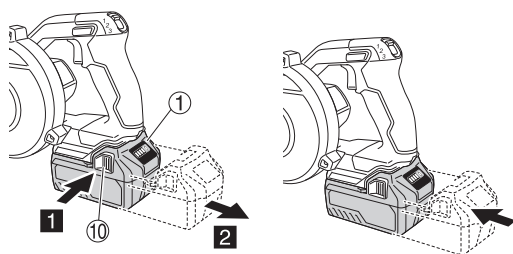
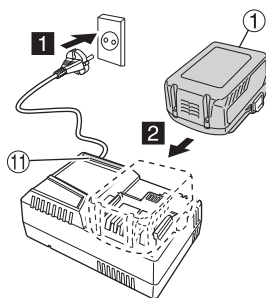
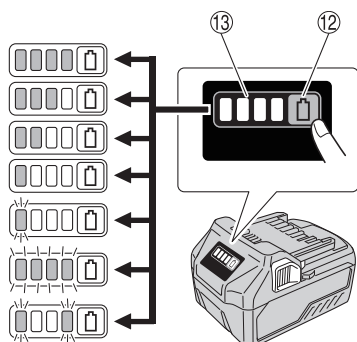
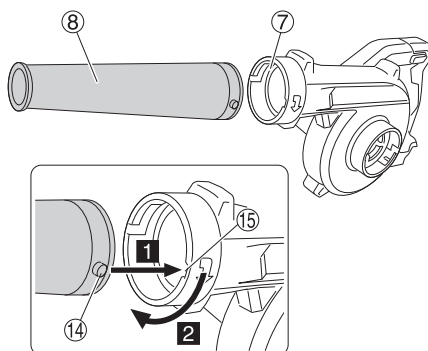
**1****2****3****4****5**

6

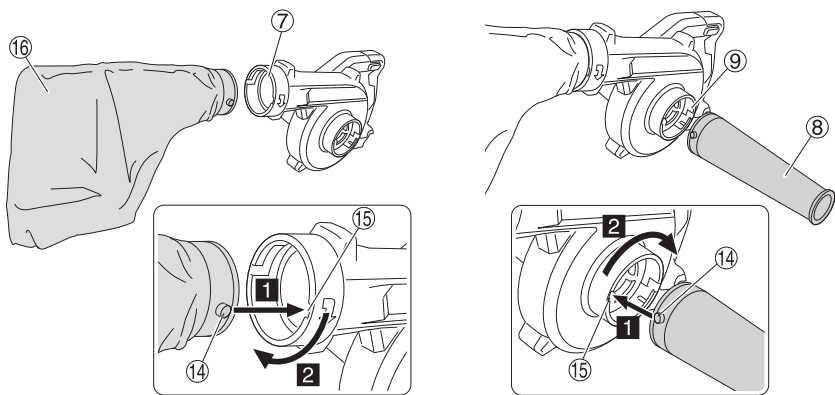

7

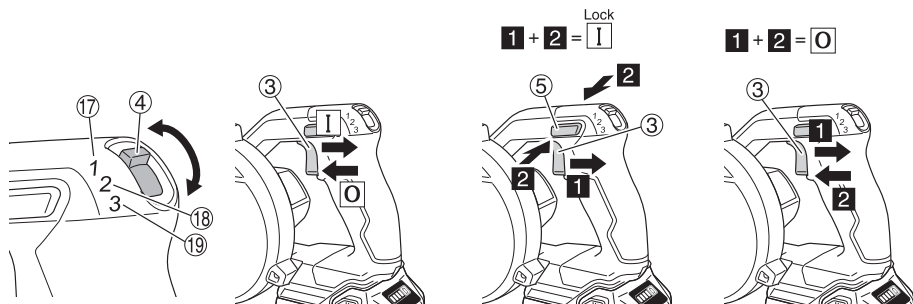

8

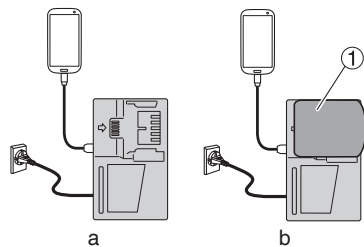

9

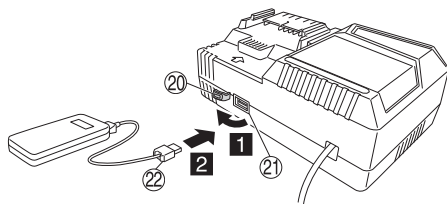

10

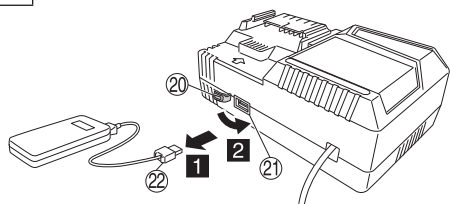

## GENERAL POWER TOOL SAFETY WARNINGS

### WARNING

Read all safety warnings, instructions, illustrations and specifications provided with this power tool.

Failure to follow all instructions listed below may result in electric shock, fire and/or serious injury.

Save all warnings and instructions for future reference.

The term "power tool" in the warnings refers to your mains-operated (corded) power tool or battery-operated (cordless) power tool.

#### 1) Work area safety

- a) **Keep work area clean and well lit.**  
*Cluttered or dark areas invite accidents.*
- b) **Do not operate power tools in explosive atmospheres, such as in the presence of flammable liquids, gases or dust.**  
*Power tools create sparks which may ignite the dust or fumes.*
- c) **Keep children and bystanders away while operating a power tool.**  
*Distractions can cause you to lose control.*

#### 2) Electrical safety

- a) **Power tool plugs must match the outlet. Never modify the plug in any way. Do not use any adapter plugs with earthed (grounded) power tools.**  
*Unmodified plugs and matching outlets will reduce risk of electric shock.*
- b) **Avoid body contact with earthed or grounded surfaces, such as pipes, radiators, ranges and refrigerators.**  
*There is an increased risk of electric shock if your body is earthed or grounded.*
- c) **Do not expose power tools to rain or wet conditions.**  
*Water entering a power tool will increase the risk of electric shock.*
- d) **Do not abuse the cord. Never use the cord for carrying, pulling or unplugging the power tool. Keep cord away from heat, oil, sharp edges or moving parts.**  
*Damaged or entangled cords increase the risk of electric shock.*
- e) **When operating a power tool outdoors, use an extension cord suitable for outdoor use.**  
*Use of a cord suitable for outdoor use reduces the risk of electric shock.*
- f) **If operating a power tool in a damp location is unavoidable, use a residual current device (RCD) protected supply.**  
*Use of an RCD reduces the risk of electric shock.*

#### 3) Personal safety

- a) **Stay alert, watch what you are doing and use common sense when operating a power tool. Do not use a power tool while you are tired or under the influence of drugs, alcohol or medication.**  
*A moment of inattention while operating power tools may result in serious personal injury.*
- b) **Use personal protective equipment. Always wear eye protection.**  
*Protective equipment such as a dust mask, non-skid safety shoes, hard hat or hearing protection used for appropriate conditions will reduce personal injuries.*

- c) **Prevent unintentional starting. Ensure the switch is in the off-position before connecting to power source and/or battery pack, picking up or carrying the tool.**

*Carrying power tools with your finger on the switch or energising power tools that have the switch on invites accidents.*

- d) **Remove any adjusting key or wrench before turning the power tool on.**  
*A wrench or a key left attached to a rotating part of the power tool may result in personal injury.*
  - e) **Do not overreach. Keep proper footing and balance at all times.**  
*This enables better control of the power tool in unexpected situations.*
  - f) **Dress properly. Do not wear loose clothing or jewellery. Keep your hair and clothing away from moving parts.**  
*Loose clothes, jewellery or long hair can be caught in moving parts.*
  - g) **If devices are provided for the connection of dust extraction and collection facilities, ensure these are connected and properly used.**  
*Use of dust collection can reduce dust-related hazards.*
  - h) **Do not let familiarity gained from frequent use of tools allow you to become complacent and ignore tool safety principles.**  
*A careless action can cause severe injury within a fraction of a second.*
- #### 4) Power tool use and care
- a) **Do not force the power tool. Use the correct power tool for your application.**  
*The correct power tool will do the job better and safer at the rate for which it was designed.*
  - b) **Do not use the power tool if the switch does not turn it on and off.**  
*Any power tool that cannot be controlled with the switch is dangerous and must be repaired.*
  - c) **Disconnect the plug from the power source and/or remove the battery pack, if detachable, from the power tool before making any adjustments, changing accessories, or storing power tools.**  
*Such preventive safety measures reduce the risk of starting the power tool accidentally.*
  - d) **Store idle power tools out of the reach of children and do not allow persons unfamiliar with the power tool or these instructions to operate the power tool.**  
*Power tools are dangerous in the hands of untrained users.*
  - e) **Maintain power tools and accessories. Check for misalignment or binding of moving parts, breakage of parts and any other condition that may affect the power tool's operation. If damaged, have the power tool repaired before use.**  
*Many accidents are caused by poorly maintained power tools.*
  - f) **Keep cutting tools sharp and clean.**  
*Properly maintained cutting tools with sharp cutting edges are less likely to bind and are easier to control.*
  - g) **Use the power tool, accessories and tool bits etc. in accordance with these instructions, taking into account the working conditions and the work to be performed.**  
*Use of the power tool for operations different from those intended could result in a hazardous situation.*
  - h) **Keep handles and grasping surfaces dry, clean and free from oil and grease.**  
*Slippery handles and grasping surfaces do not allow for safe handling and control of the tool in unexpected situations.*

- 5) **Battery tool use and care**
- a) **Recharge only with the charger specified by the manufacturer.**  
*A charger that is suitable for one type of battery pack may create a risk of fire when used with another battery pack.*
  - b) **Use power tools only with specifically designated battery packs.**  
*Use of any other battery packs may create a risk of injury and fire.*
  - c) **When battery pack is not in use, keep it away from other metal objects, like paper clips, coins, keys, nails, screws or other small metal objects, that can make a connection from one terminal to another.**  
*Shorting the battery terminals together may cause burns or a fire.*
  - d) **Under abusive conditions, liquid may be ejected from the battery; avoid contact. If contact accidentally occurs, flush with water. If liquid contacts eyes, additionally seek medical help.**  
*Liquid ejected from the battery may cause irritation or burns.*
  - e) **Do not use a battery pack or tool that is damaged or modified.**  
*Damaged or modified batteries may exhibit unpredictable behaviour resulting in fire, explosion or risk of injury.*
  - f) **Do not expose a battery pack or tool to fire or excessive temperature.**  
*Exposure to fire or temperature above 130°C may cause explosion.*
  - g) **Follow all charging instructions and do not charge the battery pack or tool outside the temperature range specified in the instructions.**  
*Charging improperly or at temperatures outside the specified range may damage the battery and increase the risk of fire.*
- 6) **Service**
- a) **Have your power tool serviced by a qualified repair person using only identical replacement parts.**  
*This will ensure that the safety of the power tool is maintained.*
  - b) **Never service damaged battery packs.**  
*Service of battery packs should only be performed by the manufacturer or authorized service providers.*

## PRECAUTION

**Keep children and infirm persons away.**

**When not in use, tools should be stored out of reach of children and infirm persons.**

## CORDLESS BLOWER SAFETY WARNINGS

1. Do not put your hands or face near the cordless blower's blast port or suction port during use.  
Doing so might lead to injuries.
2. When cleaning electrical conductors such as an electrical panel, be sure there is plenty of space between the conductor and the power tool. Also, make sure to mount the nozzle when cleaning.  
Failure to mount the nozzle while cleaning the conductor can result in an electric shock.
3. Do not block the blast port and/or suction port. Also, do not allow dust to accumulate in the suction port.  
Blocking the blast port or suction port will abnormally speed up the motor's rotation which may damage the fan within the power tool and cause the motor to excessively heat up.
4. Do not use the power tool to fill a balloon or swim ring with air.
5. Do not use in locations where inflammable materials such as lacquer, paint, benzene, thinner or gasoline are present. Also do not let items such as lighted cigarette butts be suctioned inside at such locations.  
Explosion or fires might result.
6. Do not use near objects generating high heat such as stoves; do not blow at lit cigarette butts; and do not stoke or extinguish flames.  
Fires might occur if used near such locations.
7. Do not use in environments subject to heavy doses of chemicals, etc.  
Plastic sections might weaken and break, and injuries might occur.
8. If you notice that the unit is generating unusually high temperatures, operating poorly, or making abnormal noises, immediately stop using and shut off the power switch. Request an inspection and repair from the dealer where you purchased the unit or a HiKOKI Authorized Service Center.  
Continuing to use while operating abnormally might cause injuries.
9. If the unit is mistakenly dropped or strikes another object, make a thorough check of the unit for cracks, breakage or deformation, etc.  
Injuries might occur if the unit has cracks, breakage or deformation.
10. Do not place objects such as screws inside the suction port or blast port.  
Failure to do so may damage the interior parts of the tool.
11. For blowing operation, mount the nozzle to the blast port. For dust collection, mount the nozzle to the suction port and mount the dust bag on the blast port.
12. Do not use the tool to suction liquid such as water or wet dust particles, or items such as bits of glass, cutting tools, nails, screws, pebbles, or lit cigarette butts.
13. Do not use industrial oil or grease (cutting oil, lubricant, etc.), or in the vicinity of chemicals.  
Doing so may cause parts to deteriorate or cause damage.
14. Make a thorough inspection if using the cordless blower to blow or clean viscous powder or dust particles.  
Powder or dust particles might be suctioned in and adhere internally, causing the vanes to break or injuries to occur.
15. Never touch moving parts.  
Never place your hands, fingers or other body parts near the tool's moving parts.
16. NEVER leave tool running unattended. Turn power off.  
Don't leave tool until it comes to a complete stop.
17. When operating the tool in high locations, make sure there is nobody below.
18. Be careful when blowing large amounts of fine dust in a dry environment as it can cause an accumulation of static electricity which can result in an unexpected electric discharge.
19. Never point toward people or animals. The machine blows small objects at a high velocity and can cause injury.
20. Never operate from an unstable footing, such as when on a ladder or step ladder.  
Doing so may cause an injury.
21. Do not strike the tool with other objects; avoid strong impacts such as dropping the tool; and do not allow the tool to get wet.  
Any one of these can damage the built-in precision parts and result in malfunction.
22. Before operation, remove any objects in the area that may cause injury or accident.
23. Do not peep into the blast port during operation.
24. Keep the suction port away from your body to avoid sucking in your work clothes.

25. If any foreign material enters the suction port and stops the blast of air, immediately switch off the tool, remove the battery and then extract the foreign material.
26. Precautions during transport
  - Release the switch on the body of the machine and remove the battery.
  - Carry the machine by the handle on its body.
  - When transporting it via vehicle, take appropriate steps to prevent it from falling over or being damaged.

## ADDITIONAL SAFETY WARNINGS

1. Always charge the battery at a temperature of 0°C–40°C. A temperature of less than 0°C will result in over charging which is dangerous. The battery cannot be charged at a temperature higher than 40°C.  
The most suitable temperature for charging is that of 20°C–25°C.
2. Do not use the charger continuously. When one charging is completed, leave the charger for about 15 minutes before the next charging of battery.
3. Do not allow foreign matter to enter the hole for connecting the rechargeable battery.
4. Never disassemble the rechargeable battery and charger.
5. Never short-circuit the rechargeable battery. Shortcircuiting the battery will cause a great electric current and overheat. It results in burn or damage to the battery.
6. Do not dispose of the battery in fire. If the battery is burnt, it may explode.
7. Bring the battery to the shop from which it was purchased as soon as the post-charging battery life becomes too short for practical use. Do not dispose of the exhausted battery.
8. Do not insert object into the air ventilation slots of the charger. Inserting metal objects or inflammables into the charger air ventilation slots will result in electrical shock hazard or damaged charger.
9. When using this unit continuously, the unit may overheat, leading to damage in the motor and switch. Therefore, whenever the housing becomes hot, give the tool a break for a while.
10. Make sure that the battery is installed firmly. If it is at all loose it could come off and cause an accident.
11. Do not use the product if the tool or the battery terminals (battery mount) are deformed.  
Installing the battery could cause a short circuit that could result in smoke emission or ignition.
12. Keep the tool's terminals (battery mount) free of swarf and dust.
  - Prior to use, make sure that swarf and dust have not collected in the area of the terminals.
  - During use, try to avoid swarf or dust on the tool from falling on the battery.
  - When suspending operation or after use, do not leave the tool in an area where it may be exposed to falling swarf or dust.  
Doing so could cause a short circuit that could result in smoke emission or ignition.
13. Always use the tool and battery at temperatures between -5°C and 40°C.

## CAUTION ON LITHIUM-ION BATTERY

To extend the lifetime, the lithium-ion battery equips with the protection function to stop the output. In the cases of 1 to 3 described below, when using this product, even if you are pulling the switch, the motor may stop. This is not the trouble but the result of protection function.

1. When the battery power remaining runs out, the motor stops.  
In such a case, charge it up immediately.
2. If the tool is overloaded, the motor may stop. In this case, release the switch of tool and eliminate causes of overloading. After that, you can use it again.
3. If the battery is overheated under overload work, the battery power may stop.  
In this case, stop using the battery and let the battery cool. After that, you can use it again.

Furthermore, please heed the following warning and caution.  
**WARNING**

In order to prevent any battery leakage, heat generation, smoke emission, explosion and ignition beforehand, please be sure to heed the following precautions.

1. Make sure that swarf and dust do not collect on the battery.
    - During work make sure that swarf and dust do not fall on the battery.
    - Make sure that any swarf and dust falling on the power tool during work do not collect on the battery.
    - Do not store an unused battery in a location exposed to swarf and dust.
    - Before storing a battery, remove any swarf and dust that may adhere to it and do not store it together with metal parts (screws, nails, etc.).
  2. Do not pierce battery with a sharp object such as a nail, strike with a hammer, step on, throw or subject the battery to severe physical shock.
  3. Do not use an apparently damaged or deformed battery.
  4. Do not use the battery in reverse polarity.
  5. Do not connect directly to an electrical outlets or car cigarette lighter sockets.
  6. Do not use the battery for a purpose other than those specified.
  7. If the battery charging fails to complete even when a specified recharging time has elapsed, immediately stop further recharging.
  8. Do not put or subject the battery to high temperatures or high pressure such as into a microwave oven, dryer, or high pressure container.
  9. Keep away from fire immediately when leakage or foul odor are detected.
  10. Do not use in a location where strong static electricity generates.
  11. If there is battery leakage, foul odor, heat generated, discolored or deformed, or in any way appears abnormal during use, recharging or storage, immediately remove it from the equipment or battery charger, and stop use.
  12. Do not immerse the battery or allow any fluids to flow inside. Conductive liquid ingress, such as water, can cause damage resulting in fire or explosion. Store your battery in a cool, dry place, away from combustible and flammable items. Corrosive gas atmospheres must be avoided.
- CAUTION**
1. If liquid leaking from the battery gets into your eyes, do not rub your eyes and wash them well with fresh clean water such as tap water and contact a doctor immediately.  
If left untreated, the liquid may cause eye-problems.
  2. If liquid leaks onto your skin or clothes, wash well with clean water such as tap water immediately.  
There is a possibility that this can cause skin irritation.
  3. If you find rust, foul odor, overheating, discolor, deformation, and/or other irregularities when using the battery for the first time, do not use and return it to your supplier or vendor.

## WARNING

If a conductive foreign matter enters in the terminal of lithium ion battery, the battery may be shorted, causing fire. When storing the lithium ion battery, obey surely the rules of following contents.

- Do not place conductive debris, nail and wires such as iron wire and copper wire in the storage case.
- To prevent shorting from occurring, load the battery in the tool or insert securely the battery cover for storing until the ventilator is not seen.

## REGARDING LITHIUM-ION BATTERY TRANSPORTATION

When transporting a lithium-ion battery, please observe the following precautions.

### WARNING

Notify the transportation company that a package contains a lithium-ion battery, inform the company of its power output and follow the instructions of the transportation company when arranging transport.

- Lithium-ion batteries that exceed a power output of 100 Wh are considered to be in the freight classification of Dangerous Goods and will require special application procedures.
- For transportation abroad, you must comply with international law and the rules and regulations of the destination country.

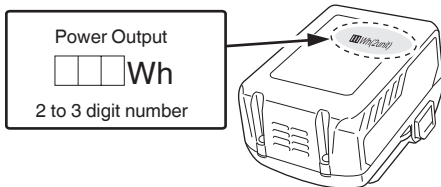

## USB DEVICE CONNECTION PRECAUTIONS (UC18YSL3)

When an unexpected problem occurs, the data in a USB device connected to this product may be corrupted or lost. Always make sure to back up any data contained in the USB device prior to use with this product.

Please be aware that our company accepts absolutely no responsibility for any data stored in a USB device that is corrupted or lost, nor for any damage that may occur to a connected device.

### WARNING

- Prior to use, check the connecting USB cable for any defect or damage.  
Using a defective or damaged USB cable can cause smoke emission or ignition.
- When the product is not being used, cover the USB port with the rubber cover.  
Buildup of dust etc. in the USB port can cause smoke emission or ignition.

### NOTE

- There may be an occasional pause during USB recharging.
- When a USB device is not being charged, remove the USB device from the charger.  
Failure to do so may not only reduce the battery life of a USB device, but may also result in unexpected accidents.
- It may not be possible to charge some USB devices, depending on the type of device.

## NAMES OF PARTS (Fig. 1–Fig. 10)

①	Battery (sold separately)
②	Handle
③	Switch
④	Air volume changing lever
⑤	ON lock button
⑥	Motor and fan
⑦	Blast port
⑧	Nozzle
⑨	Suction port
⑩	Latch
⑪	Charge indicator lamp
⑫	Battery level indicator switch
⑬	Battery level indicator lamp
⑭	Pin
⑮	Groove
⑯	Dust bag (sold separately)
⑰	Air volume: low
⑱	Air volume: medium
⑲	Air volume: high
⑳	Rubber cover
㉑	USB port
㉒	USB cable



## SYMBOLS

### WARNING

The following show symbols used for the machine. Be sure that you understand their meaning before use.







	RB18DC: Cordless Blower
	To reduce the risk of injury, user must read instruction manual.
	Direct current
	Rated voltage
	No-load speed
	Disconnect the battery
	Switching ON
	Switching OFF



 Lock	Switch locks to the "ON" position
 Warning	

- \*1 BSL36A18, when fully charged
- \*2 With nozzle
- \*3 Without nozzle
- \*4 For guidance purposes only. Results will differ according to situations such as operating environment and battery condition.
- \*5 Existing batteries (BSL3660/3620/3626, etc.) cannot be used with this tool.

## Battery

	Lights ; The battery remaining power is over 75%
	Lights ; The battery remaining power is 50%–75%.
	Lights ; The battery remaining power is 25%–50%.
	Lights ; The battery remaining power is less than 25%
	Blinks ; The battery remaining power is nearly empty. Recharge the battery soonest possible.
	Blinks ; Output suspended due to high temperature. Remove the battery from the tool and allow it to fully cool down.
	Blinks ; Output suspended due to failure or malfunction. The problem may be the battery so please contact your dealer.

## NOTE

Due to HiKOKI's continuing program of research and development, the specifications herein are subject to change without prior notice.

## 2. Battery (sold separately)

Model	BSL36A18	BSL36B18
Voltage	36 V / 18 V (Automatic Switching*)	
Battery capacity	2.5 Ah / 5.0 Ah	4.0 Ah / 8.0 Ah
	(Automatic Switching*)	
Available cordless products**	Multi volt series, 18 V product	
Available charger	Sliding charger for lithium ion batteries	

- \* The tool itself will automatically switch over.
- \*\* Please see our general catalogue for details.

## 3. Charger (sold separately)

Model	UC18YSL3
Charging voltage	14.4 V–18 V
Weight	0.6 kg

## STANDARD ACCESSORIES

In addition to the main unit (1 unit), the package contains the accessories listed on page 13.

Standard accessories are subject to change without notice.

## APPLICATIONS

- Cleaning facilities and equipment in lumbermills, cigarette-making plants, spinning mills, etc.
- Cleaning devices and equipment in repair shops.
- Blowing operation.

## SPECIFICATIONS

### 1. Power tool

Model	RB18DC	
Voltage	18 V	
No-Load Speed*1	0–20000 /min	
Air velocity	Maximum*2	0–95 m/s
	Average*2	0–78 m/s
Air volume*3	0–3.5 m <sup>3</sup> /min	
Continuous operating time*4	3: Approximately 20 minutes 2: Approximately 55 minutes 1: Approximately 130 minutes	
Battery available for this tool*5	Multi volt battery, BSL18 Series	
Weight	1.8 kg (BSL36A18) 2.1 kg (BSL36B18)	

## BATTERY REMOVAL/INSTALLATION

### 1. Battery removal

Hold the housing tightly and push the battery latches to remove the battery (see Fig. 2).

### CAUTION

Never short-circuit the battery.

### 2. Battery installation

Insert the battery while observing its polarities (see Fig. 2).

## CHARGING

Before using the power tool, charge the battery as follows.

**1. Connect the charger's power cord to the receptacle.**  
When connecting the plug of the charger to a receptacle, the charge indicator lamp will blink in red (At 1- second intervals).

**2. Insert the battery into the charger.**

Firmly insert the battery into the charger as shown in Fig. 3 (on page 2).

**3. Charging**

When inserting a battery in the charger, the charge indicator lamp will blink in blue.

When the battery becomes fully recharged, the charge indicator lamp will light up in green. (See Table 1)

(1) Charge indicator lamp indication

The indications of the charge indicator lamp will be as shown in Table 1, according to the condition of the charger or the rechargeable battery.



**Table 1**

Indications of the charge indicator lamp				
Charge indicator lamp (RED / BLUE / GREEN / PURPLE)	Before charging	Blinks (RED)	Lights for 0.5 seconds. Does not light for 0.5 seconds. (off for 0.5 seconds)	Plugged into power source
	While charging	Blinks (BLUE)	Lights for 0.5 seconds. Does not light for 1 second. (off for 1 second)	Battery capacity at less than 50%
		Blinks (BLUE)	Lights for 1 second. Does not light for 0.5 seconds. (off for 0.5 seconds)	Battery capacity at less than 80%
		Lights (BLUE)	Lights continuously	Battery capacity at more than 80%
	Charging complete	Lights (GREEN)	Lights continuously (Continuous buzzer sound: about 6 seconds)	
	Overheat standby	Blinks (RED)	Lights for 0.3 seconds. Does not light for 0.3 seconds. (off for 0.3 seconds)	Battery overheated. Unable to charge. (Charging will commence when battery cools)
	Charging impossible	Flickers (PURPLE)	Lights for 0.1 seconds. Does not light for 0.1 seconds. (Intermittent buzzer sound: about 2 seconds)	Malfunction in the battery or the charger

(2) Regarding the temperatures and charging time of the rechargeable battery  
The temperatures and charging time will become as shown in **Table 2**.

**Table 2**

Charger		UC18YSL3					
Battery	Type of battery	Li-ion					
	Temperatures at which the battery can be recharged	0°C–50°C					
	Charging voltage	V	14.4		18		
	Charging time, approx. (At 20°C)	min	BSL14xx series		BSL18xx series		Multi volt series
			(4 cells)	(8 cells)	(5 cells)	(10 cells)	(10 cells)
		BSL1415S : 15 BSL1415 : 15 BSL1415X : 15 BSL1420 : 20 BSL1425 : 25 BSL1430C : 30	BSL1430 : 20 BSL1440 : 26 BSL1450 : 32 BSL1460 : 38	BSL1815S : 15 BSL1815 : 15 BSL1815X : 15 BSL1820 : 20 BSL1825 : 25 BSL1830C : 30 BSL1850C : 32	BSL1830 : 20 BSL1840 : 26 BSL1850 : 32 BSL1860 : 38	BSL36A18 : 32 BSL36B18 : 52	
USB	Charging voltage	V	5				
	Charging current	A	2				

**NOTE**

The recharging time may vary according to the ambient temperature and power source voltage.

**4. Disconnect the charger's power cord from the receptacle.**

**5. Hold the charger firmly and pull out the battery.**

**NOTE**

Be sure to pull out the battery from the charger after use, and then keep it.

**Regarding electric discharge in case of new batteries, etc.**

As the internal chemical substance of new batteries and batteries that have not been used for an extended period is not activated, the electric discharge might be low when using them the first and second time. This is a temporary phenomenon, and normal time required for recharging will be restored by recharging the batteries 2–3 times.

## How to make the batteries perform longer.

- (1) Recharge the batteries before they become completely exhausted.

When you feel that the power of the tool becomes weaker, stop using the tool and recharge its battery. If you continue to use the tool and exhaust the electric current, the battery may be damaged and its life will become shorter.

- (2) Avoid recharging at high temperatures.

A rechargeable battery will be hot immediately after use. If such a battery is recharged immediately after use, its internal chemical substance will deteriorate, and the battery life will be shortened. Leave the battery and recharge it after it has cooled for a while.

### CAUTION

- If the battery is charged while it is heated because it has been left for a long time in a location subject to direct sunlight or because the battery has just been used, the charge indicator lamp of the charger lights for 0.3 seconds, does not light for 0.3 seconds (off for 0.3 seconds). In such a case, first let the battery cool, then start charging.
- When the charge indicator lamp flickers (at 0.2-second intervals), check for and take out any foreign objects in the charger's battery connector. If there are no foreign objects, it is probable that the battery or charger is malfunctioning. Take it to your authorized Service Center.
- Since the built-in micro computer takes about 3 seconds to confirm that the battery being charged with UC18YSL3 is taken out, wait for a minimum of 3 seconds before reinserting it to continue charging. If the battery is reinserted within 3 seconds, the battery may not be properly charged.

## MOUNTING AND OPERATION

Action	Figure	Page
Removing and inserting the battery (sold separately)	2	2
Charging	3	2
Remaining battery indicator	4	2
Attachment of a Nozzle*1*2	5	2
Dust-collecting work*2	6	3
Switch operation*3	7	3
Charging a USB device from a electrical outlet	8-a	3
Charging a USB device and battery from a electrical outlet	8-b	3
How to recharge USB device	9	3
When charging of USB device is completed	10	3
Selecting accessories	—	14

\*1 Before conducting a blowing operation, blow out air in a location where there is nobody nearby to make sure the tool is free of any residue.

\*2 Turn the nozzle until a click is heard.

\*3 During operation, the unit can generate static electricity which may cause the motor to stop. This is a protective feature and not a malfunction. Draw the switch in once again to restart the motor.

## MAINTENANCE AND INSPECTION

### WARNING

Be sure to turned off the switch and remove the battery before maintenance and inspection.

1. **Inspecting the mounting screws**  
Regularly inspect all mounting screws and ensure that they are properly tightened. Should any of the screws be loose, retighten them immediately. Failure to do so could result in serious hazard.
2. **Maintenance of the motor**  
The motor unit winding is the very "heart" of the power tool. Exercise due care to ensure the winding does not become damaged and/or wet with oil or water.
3. **Inspection of terminals (tool and battery)**  
Check to make sure that swarf and dust have not collected on the terminals.  
On occasion check prior, during and after operation.

### CAUTION

Remove any swarf or dust which may have collected on the terminals.

Failure to do so may result in malfunction.

4. **Cleaning on the outside**

When the cordless blower is stained, wipe with a soft dry cloth or a cloth moistened with soapy water. Do not use chloric solvents, gasoline or paint thinner, for they melt plastics.

If the nose grill is blocked with debris, the blower will work less efficiently.

Clean it gently when necessary with a soft brush.

5. **Storage**

Store the cordless blower and the battery in a place in which the temperature is less than 40°C and out of reach of children.

### NOTE

Storing lithium-ion batteries.

Make sure the lithium-ion batteries have been fully charged before storing them.

Prolonged storage (3 months or more) of batteries with a low charge may result in performance deterioration, significantly reducing battery usage time or rendering the batteries incapable of holding a charge.

However, significantly reduced battery usage time may be recovered by repeatedly charging and using the batteries two to five times.

If the battery usage time is extremely short despite repeated charging and use, consider the batteries dead and purchase new batteries.

### CAUTION

In the operation and maintenance of power tools, the safety regulations and standards prescribed in each country must be observed.

## SELECTING ACCESSORIES

The accessories of this machine are listed on page 14.

For details regarding each bit type, please contact the HiKOKI Authorized Service Center.

### Important notice on the batteries for the HiKOKI cordless power tools

Please always use one of our designated genuine batteries. We cannot guarantee the safety and performance of our cordless power tool when used with batteries other than these designated by us, or when the battery is disassembled and modified (such as disassembly and replacement of cells or other internal parts).

**NOTE**

Due to HiKOKI's continuing program of research and development, the specifications herein are subject to change without prior notice.

**TROUBLESHOOTING**

Use the inspections in the table below if the tool does not operate normally. If this does not remedy the problem, consult your dealer or the HiKOKI Authorized Service Center.

## 1. Power tool

Symptom	Possible cause	Remedy
Tool doesn't run	No remaining battery power	Charge the battery.
Tool suddenly stopped	The battery is overheated.	Let the battery cool down.
Poor suction	Dust bag is full.	Dispose the dust.
	Nozzle is plugged.	Remove the obstruction.
	Nozzle is cracked or damaged.	Exchange the unit with a new one.
Battery cannot be installed	Attempting to install a battery other than that specified for the tool.	Please install batteries that are multi volt or BSL18xx series.

## 2. Charger

Symptom	Possible cause	Remedy
The charge indicator lamp rapidly flickers purple, and battery charging doesn't begin.	The battery is not inserted all the way.	Insert the battery firmly.
	There is foreign matter in the battery terminal or where the battery is attached.	Remove the foreign matter.
The charge indicator lamp blinks red, and battery charging doesn't begin.	The battery is not inserted all the way.	Insert the battery firmly.
	The battery is overheated.	If left alone, the battery will automatically begin charging if its temperature decreases, but this may reduce battery life. It is recommended that the battery be cooled in a well-ventilated location away from direct sunlight before charging it.
Battery usage time is short even though the battery is fully charged.	The battery's life is depleted.	Replace the battery with a new one.
The battery takes a long time to charge.	The temperature of the battery, the charger, or the surrounding environment is extremely low.	Charge the battery indoors or in another warmer environment.
	The charger's vents are blocked, causing its internal components to overheat.	Avoid blocking the vents.
	The cooling fan is not running.	Contact a HiKOKI Authorized Service Center for repairs.
The USB power lamp has switched off and the USB device has stopped charging.	The battery's capacity has become low.	Replace the battery with one that has capacity remaining.
		Plug the charger's power plug into an electric socket.
USB power lamp does not switch off even though the USB device has finished charging.	The USB power lamp lights up green to indicate that USB charging is possible.	This is not a malfunction.
It is unclear what the charging status of a USB device is, or whether its charging is complete.	The USB power lamp does not switch off even when charging is complete.	Examine the USB device that is charging to confirm its charging status.

Symptom	Possible cause	Remedy
Charging of a USB device pauses midway.	The charger was plugged into an electrical socket while the USB device was being charged using the battery as the power source.	This is not a malfunction. The charger pauses USB charging for about 5 seconds when it is differentiating between power sources.
	A battery was inserted into the charger while the USB device was being charged using a power socket as the power source.	
Charging of the USB device pauses midway when the battery and the USB device are being charged at the same time.	The battery has become fully charged.	This is not a malfunction. The charger pauses USB charging for about 5 seconds while it checks whether the battery has successfully completed charging.
Charging of the USB device doesn't start when the battery and the USB device are being charged at the same time.	The remaining battery capacity is extremely low.	This is not a malfunction. When the battery capacity reaches a certain level, USB charging automatically begins.

	RB18DC
	(NN)
	1



323582

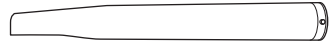

317124



990046



323587



323588

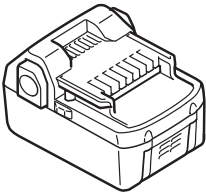

BSL18..

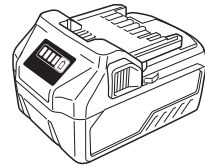
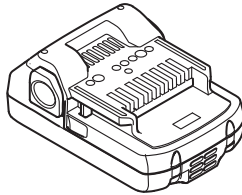

BSL36..18

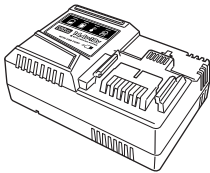

UC18YSL3 (14.4 V-18 V)

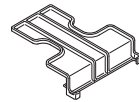

329897

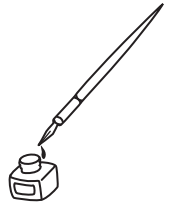



# Koki Holdings Co., Ltd.

Shinagawa Intercity Tower A, 15-1, Konan 2-chome,  
Minato-ku, Tokyo, Japan