

HIKOKI

中文
English

角向磨光机
Disc Grinder

G 13SE3

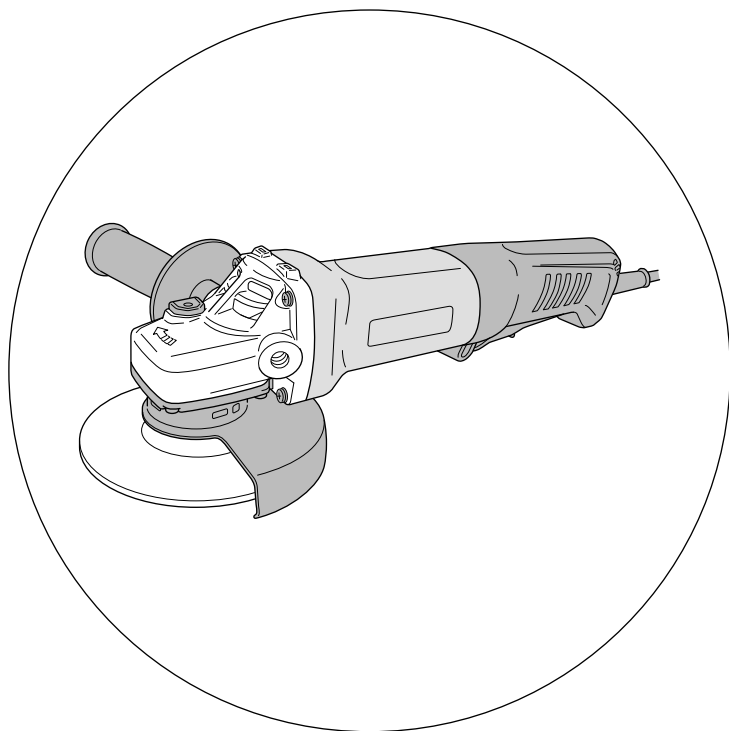

保留备用
Keep for future reference



使用说明书
Handling instructions



目次

电动工具通用安全警告	2	标准附件.....	8
砂磨或砂磨切断操作的 专用安全警告.....	4	用途.....	8
反弹和相关警告.....	5	作业之前	8
砂磨操作的专用安全警告.....	6	实用角向磨光机的应用.....	10
角向磨光机的一般安全说明.....	6	砂轮的组装与分解.....	11
符号.....	7	维护和检查.....	12
规格.....	7	选择附件.....	13

电动工具通用安全警告

⚠ 警告！

阅读所有警告和所有说明。

不遵照以下警告和说明会导致电击、着火和 / 或严重伤害。

保存所有警告和说明书以备查阅。

在所有下列的警告中术语“电动工具”指市电驱动(有线)电动工具或电池驱动(无线)电动工具。

1) 工作场地的安全

- a) 保持工作场地清洁和明亮。
混乱和黑暗的场地会引发事故。
- b) 不要在易爆环境，如有易燃液体、气体或粉尘的环境下操作电动工具。
电动工具产生的火花会点燃粉尘或气体。
- c) 让儿童和旁观者离开后操作电动工具。
注意力不集中会使操作者失去对工具的控制。

2) 电气安全

- a) 电动工具插头必须与插座相配。绝不能以任何方式改装插头。
需接地的电动工具不能使用任何转换插头。
未经改装的插头和相配的插座将减少电击危险。
- b) 避免人体接触接地表面，如管道、散热片和冰箱。
如果你身体接地会增加电击危险。
- c) 不得将电动工具暴露在雨中或潮湿环境中。
水进入电动工具将增加电击危险。
- d) 不得滥用电线。绝不能用电线搬运、拉动电动工具或拔出其插头。
使电线远离热源、油、锐边或运动部件。
受损或缠绕的软线会增加电击危险。

- e) 当在户外使用电动工具时，使用适合户外使用的外接软线。
适合户外使用的软线将减少电击危险。
- f) 如果在潮湿环境下操作电动工具是不可避免的，应使用剩余电流动作保护器（RCD）。
使用RCD可减小电击危险。

3) 人身安全

- a) 保持警觉，当操作电动工具时关注所从事的操作并保持清醒。
当你感到疲倦，或在有药物、酒精或治疗反应时，不要操作电动工具。
在操作电动工具时瞬间的疏忽会导致严重人身伤害。
- b) 使用个人防护装置。始终佩戴护目镜。
安全装置，诸如适当条件下使用防尘面具、防滑安全鞋、安全帽、听力防护等装置能减少人身伤害。
- c) 防止意外起动。确保开关在连接电源和 / 或电池盒、拿起或搬运工具时处于关断位置。
手指放在已接通电源的开关上或开关处于接通时插入插头可能会导致危险。
- d) 在电动工具接通之前，拿掉所有调节钥匙或扳手。
遗留在电动工具旋转零件上的扳手或钥匙会导致人身伤害。
- e) 手不要伸展得太长。时刻注意立足点和身体平衡。
这样在意外情况下能很好地控制电动工具。
- f) 着装适当。不要穿宽松衣服或佩戴饰品。让衣服、手套和头发远离运动部件。
宽松衣服、佩饰或长发可能会卷入运动部件中。
- g) 如果提供了与排屑、集尘设备连接用的装置，要确保它们连接完好且使用得当。
使用这些装置可减少尘屑引起的危险。

4) 电动工具使用和注意事项

- a) 不要滥用电动工具，根据用途使用适当的电动工具。
选用适当设计的电动工具会使你工作更有效、更安全。
- b) 如果开关不能接通或关断工具电源，则不能使用该电动工具。
不能用开关来控制的电动工具是危险的且必须进行修理。
- c) 在进行任何调节、更换附件或贮存电动工具之前，必须从电源上拔掉插头和 / 或使电池盒与工具脱开。
这种防护性措施将减少工具意外起动的危险。
- d) 将闲置不用的电动工具贮存在儿童所及范围之外，并且不要让不熟悉电动工具或对这些说明不了解的人操作电动工具。
电动工具在未经培训的用户手中是危险的。

- e) 保养电动工具。检查运动件是否调整到位或卡住，检查零件破损情况和影响电动工具运行的其他状况。如有损坏，电动工具应在使用前修理好。许多事故由维护不良的电动工具引发。
- f) 保持切削刀具锋利和清洁。
保养良好的有锋利切削刃的刀具不易卡住而且容易控制。
- g) 按照使用说明书，考虑作业条件和进行的作业来使用电动工具、附件和工具的刀头等。
将电动工具用于那些与其用途不符的操作可能会导致危险。

5) 维修

- a) 将你的电动工具送交专业维修人员，使用同样的备件进行修理。
这样将确保所维修的电动工具的安全性。

注意事项

不可让儿童和体弱人士靠近工作场所。

应将不使用的工具存放在儿童和体弱人士接触不到的地方。

砂磨或砂磨切断操作的专用安全警告

- a) 只使用所推荐的砂轮型号和为选用砂轮专门设计的护罩。
不是为电动工具设计的砂轮不能充分得到防护，是不安全的。
- b) 中央凹陷磨轮的磨削面必须安装在护刃器唇平面的下方。
磨轮安装不正确，通过护刃器唇平面的操作无法得到妥善保护。
- c) 不使用非工具制造商推荐和专门设计的附件。
否则该附件可能被装到你的电动工具上，而它不能保证安全操作。
- d) 附件的额定速度必须至少等于电动工具上标出的最大速度。
附件以比其额定速度大的速度运转会发生爆裂和飞溅。
- e) 附件的外径和厚度必须在电动工具额定能力范围之内。
不正确的附件尺寸不能得到充分防护或控制。
- f) 配件螺纹安装必须与磨床主轴螺纹相匹配。通过法兰安装配件时，配件的轴孔必须适合法兰的定位直径。
如果配件与动力工具的装载硬件不匹配，可能导致工具失去平衡、剧烈振动和失去控制。
- g) 不要使用损坏的附。在每次使用前要检查附件，例如砂轮是否有碎片和裂缝，靠背垫是否有裂缝、撕裂或过度磨损，钢丝刷是否松动或金属丝是否断裂。如果电动工具或附件跌落了，检查是否有损坏或安装没有损坏的附件。检查和安装附件后，让自己和旁观者的位置远离旋转附件的平面，并以电动工具最大空载速度运行 1min。
损坏的附件通常在该试验时会碎裂。

- h) 戴上防护用品。根据适用情况，使用面罩、安全护目镜或安全眼镜。适用时，戴上防尘面具、听力保护器、手套和能挡小磨料或工件碎片的工作围裙。眼防护罩必须挡住各种操作产生的飞屑。防尘面具或口罩必须能过滤操作产生的颗粒。长期暴露在高强度噪声中会引起失聪。
- i) 让旁观者与工作区域保持一安全距离。任何进入工作区域的人必须戴上防护用品。
工件或破损附件的碎片可能会飞出并引起紧靠着操作区域的旁观者的伤害。
- j) 当在切割附件有可能切割到暗线或自身电线的场所进行操作时，只能通过绝缘握持面来握住电动工具。
切割附件碰到一根带电导线可能会使电动工具的外露金属零件带电并使操作者发生电击危险。
- k) 使软线远离旋转的附件。
如果控制不当，软线可能被切断或缠绕，并使得你的手或手臂可能被卷入旋转附件中。
- l) 直到附件完全停止运动才放下电动工具。
旋转的附件可能会抓住表面并拉动电动工具而让你失去对工具的控制。
- m) 当携带电动工具时不要开动它。
意外地触及旋转附件可能会缠绕你的衣服而使附件伤害身体。
- n) 经常清理电动工具的通风口。
电动机风扇会将灰尘吸进机壳，过多的金属粉末沉积会导致电气危险。
- o) 不要在易燃材料附件操作电动工具。
火星可能会点燃这些材料。
- p) 不要使用需用冷却液的附件。
用水或其他冷却液可能会导致电腐蚀或电击。

反弹和相关警告

反弹是因卡住或缠绕住的旋转砂轮、靠背垫、钢丝刷或其他附件而产生的突然反作用力。卡住或缠绕会引起旋转附件的迅速堵转，随之使失控的电动工具在卡住点产生与附件旋转方向相反的运动。

例如，如果砂轮被工件缠绕或卡住，伸入卡住点的砂轮边缘可能会进入材料表面而引起砂轮爬出或反弹。砂轮可能飞向或飞离操作者，这取决于砂轮在卡住点的运动方向。在此条件下砂轮也可能碎裂。

反弹是电动工具误用和 / 或不正确操作工序或条件的结果，可以通过采取以下给出的适当预防措施得以避免。

- a) 保持紧握电动工具，使你的身体和手臂处于正确状态以抵抗反弹力。如有辅助手柄，则要一直使用，以便最大限度控制住起动时的反弹力或反力矩。
如采取合适的预防措施，操作者就可以控制反力矩或反弹力。
- b) 绝不能将手靠近旋转附件。
附件可能会反弹碰到手。

中文

- c) 不要站在发生反弹时电动工具可能移动到的地方。
反弹将在缠绕点驱使工具逆砂轮运动方向运动。
- d) 当在尖角、锐边等处作业时要特别小心。避免附件的弹跳和缠绕。
尖角、锐边和弹跳具有缠绕旋转附件的趋势并引起反弹的失控。
- e) 不要附装上锯链、木雕刀片或带齿锯片。
这些锯片会产生频繁的反弹和失控。

砂磨操作的专用安全警告

- a) 只使用所推荐的砂轮型号和为选用砂轮专门设计的护罩。
不是为电动工具设计的砂轮不能充分得到防护，是不安全的。
- b) 中央凹陷磨轮的磨削面必须安装在护刃器唇平面的下方。
磨轮安装不正确，通过护刃器唇平面的操作无法得到妥善保护。
- c) 护罩必须牢固地装在电动工具上，且放置得最具安全性，只有最小的砂轮部分暴露在操作人面前。
护刃器有助于保护操作员免受破损磨轮碎片、意外接触磨轮和引燃衣物火花的伤害。
- d) 砂轮只用作推荐的用途。例如：不要用切割砂轮的侧面进行磨削。
施加到砂轮侧面的力可能会使其碎裂。
- e) 始终为所选砂轮选用未损坏的、有恰当规格和形状的砂轮法兰盘。
合适的砂轮法兰盘支承砂轮可以减小砂轮破裂的可能性。切割砂轮的法兰盘可以不同于砂轮法兰盘。
- f) 不要使用从大规格电动工具上用剩的磨损砂轮。
用于大规格电动工具上的砂轮不适于较小规格工具的高速工况并可能会爆裂。

角向磨光机的一般安全说明

- 确认砂轮上所标示的转速等于或大于角磨机的额定转速；
- 确保砂轮尺寸与角磨机相符；
- 须按照厂家的使用说明书小心存放和使用磨轮；
- 使用前检查砂轮，不要使用破损、有裂缝或有其他缺陷的产品；
- 确保所安装的砂轮和节点已按照厂家的使用说明固定；
- 确保使用随研磨产品附带的吸油纸或在需要时使用吸油纸；
- 在使用前确保已正确安装并拧紧研磨产品，并在安全场所在空载状态下运转 30 秒钟，若有较大的振动或察觉到其他缺陷，则应立即停止运转。遇此情况时，检查电动工具以究明原因；
- 若电动工具配备保护装置，切勿在未使用此保护装置时使用电动工具；

- 当使用研磨切割砂轮时，请务必将切割砂轮的砂轮保护装置（另售）安装在标配的砂轮保护装置上。（图 1）
- 请勿将独立的减速轴衬或接头，以便使用大孔砂轮；
- 有关要用螺纹孔砂轮来安装的工具，确保砂轮的螺纹足够长，以适合轴长；
- 检查工件已被正确固定；
- 请勿使用切断砂轮进行侧面研磨；
- 确保使用时产生的火花不会引起危险，例如不要溅在身体上或点燃易燃物；
- 在多尘的条件下工作时，确保通风口畅通无堵塞现象。如果需要清除灰尘，首先使电动工具断开电源（使用非金属物品）并避免损坏内部零件；
- 始终采用视力和听力保护。必须使用其他个人保护装置，如口罩、手套、头盔和围裙等。
- 在切断本电动工具的电源之后，砂轮仍会继续旋转一段时间，请注意此事项。



图 1

符号

警告！

如下所示的符号用于本机。使用前请务必理解其含意。

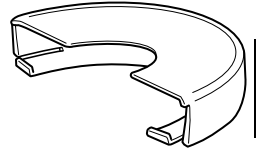

	为降低伤害风险，用户必须阅读使用说明书
	始终戴好护目镜。
	II类工具

规格

型式	G13SE3	
电压	220V ~	
输入功率	1300W	
额定转速	11500/min	
砂轮	外径×厚度×穴径	125 × 6 × 22.23mm
	圆周速度	80m / 秒
重量（仅为主机的重量）	2.5kg	

标准附件

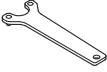
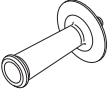
G13SE3 的附件请参见以下列表。

		G13SE3
扳手		1
侧柄		1
砂轮		1

用途

- 用于去除铸品毛刺，飞边等物及抛光各种型号的钢、青铜、铝及铸造品。
- 混凝土、石头、砖、大理石等的切削。

作业之前

1. 电源
确认所使用的电源与工具铭牌上标示的规格是否相符。
2. 电源开关
确认电源开关是否切断。若电源开关接通，则插头插入电源插座时电动工具将出其不意地立刻转动，从而招致严重事故。
3. 延伸线缆
若作业场所移到离开电源的地点，应使用容量足够、铠装合适的延伸线缆，并且要尽可能地短些。
4. 安装并调整轮罩 (图 2)
轮罩是一种保护装置用来防止作业中因砂轮破裂而受伤。开始研磨作业之前，请确认轮罩是否安装得坚固妥善。稍微拧松固定螺丝后，即可转动轮罩并将其固定在所需角度，以得到最大工作效率。调整好轮罩后，必须确认固定螺丝是否完全拧紧。

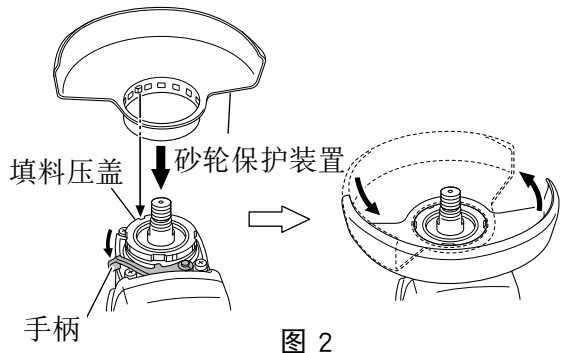

5. 确保所安装的砂轮和节点已按照厂家的使用说明固定。确保要使用的砂轮属于正确类型、没有裂纹或表面缺陷。同时也要确认砂轮装好，轮螺母紧固。参照“砂轮的组装与分解”一节。

确保使用随研磨产品自带的吸油纸或在需要时使用吸油纸。

请勿将独立的减速轴衬或接头，以便使用大孔砂轮。

有关要用螺纹孔砂轮来安装的工具，确保砂轮的螺纹足够长，以适合轴长。

请勿使用切断砂轮进行侧面研磨。

6. 磨光机的试行运转

在实际开始研磨工作之前，首先清场，确保无其他人员，然后开始测试磨光机。确保已安装了轮罩，且您佩戴了护目用具。打开磨光机，然后确保磨光机平稳运转，且无异常。

试行运转的持续时间如下所示：

在更换钹形砂轮的时候..... 3分钟或以上

在开始日常操作的时候..... 1分钟或以上

7. 检查按钮。

在开启磨光机之前按两下按钮，检查它是否已被释放。(图 3)。

8. 固定侧柄

把侧柄旋进齿轮罩。(图 4)



图 3



图 4

实用角向磨光机的应用

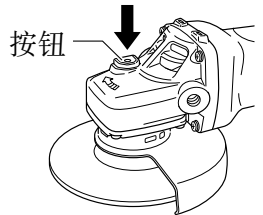
1. 开关操作

【当开关带锁定机构时】

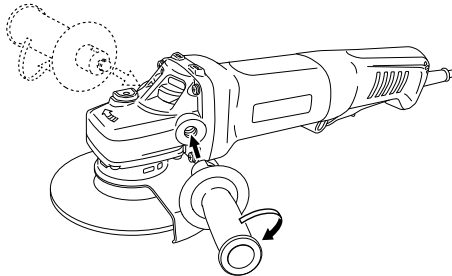
设置为“ON”：如要打开电源，请沿Ⓐ方向滑动“OFF”锁紧杆，然后沿Ⓑ方向按下拨杆，如图 5-a 所示。

此外，如图 5-b 所示的请沿Ⓒ方向滑动“ON”锁紧杆，同时按下拨杆锁定并启用连续操作。

设置为“OFF”：如要解除锁定模式，如图 5-a 所示的请沿Ⓑ方向按下拨杆，然后松开拨杆以关闭。

【当开关不带锁定机构时】

如要打开电源，请沿Ⓐ方向滑动锁紧杆，然后沿Ⓑ方向按下拨杆，如图 5-a 所示。松开拨杆以关闭。



图 5

注：

拨杆无法锁定。

2. 压力

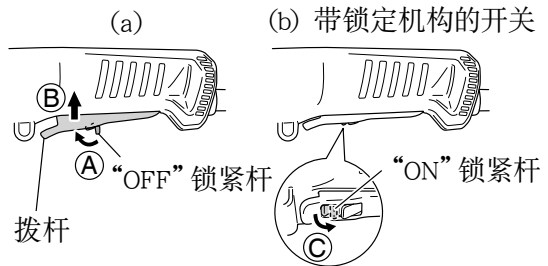
本机不可施加过大压力使其过载，这样才能延长机器的使用寿命并确保加工质量。在大部分的用法中，机器本身的重量即够研磨。加压过大将导致转速降低、表面加工不良以及过载，从而使机器寿命缩短。

3. 研磨角度

切勿将砂轮的全表面施加于要研磨的材料上。如图 6 所示，机器应保持 $15^\circ - 30^\circ$ ，使砂轮的外缘以最佳角度与工件相接触。

4. 用新砂轮首次进行研磨时，应将角向磨光机由对面横过工件往操作人员这边拉，以免挖入工件（图 6 的 B 方向）。等砂轮的前缘适当磨损后，就可往任何方向进行研磨。



图 6

5. 收工后的注意事项

在切断本电动工具的电源之后，砂轮仍会继续旋转一段时间。

关掉机器之后，需等角向磨光机完全停止才能将其放下，以免造成严重事故，而且还可以减少吸入机器的尘埃及切屑量。

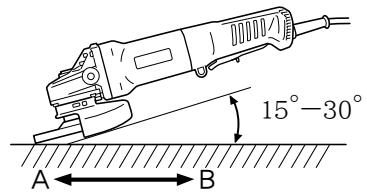
注意！

○ 检查工件已被正确固定。

○ 在多尘的条件下工作时，确保通风口畅通无堵塞现象。

如果需要清除灰尘，首先使电动工具断开电源（使用非金属物品）并避免损坏内部零件。

- 确保使用时产生的火花不会引起危险：例如，不要溅在身体上或点燃易燃物。
- 始终采用视力和听力保护。
必要时应使用其他个人保护装置，如口罩、手套、头盔和围裙等。
拿不准时，请使用保护装置。
- 未使用本电动工具时，请断开电源。

砂轮的组装与分解（图 7）

注意！

为了防备发生严重事故，必须关掉电源并将电源插头从插座中拔出。

1. 组装

- (1) 将角向磨光机的上部朝下，以使主轴朝上。
- (2) 将砂轮垫圈 (C) 的十字平面对准主轴的缺口部分，然后装上它们。
- (3) 将砂轮的突起部安装在砂轮垫圈 (C) 上。
- (4) 将砂轮螺帽拧在主轴上。
- (5) 用一只手按下按钮，同时用另一只手慢慢地转动砂轮以卡紧主轴。

如图 7 所示，用附带的扳手拧紧砂轮螺帽。



图 7

注意！

- 请确认砂轮是否安装紧固。
- 请在打开电源开关之前，按两下按钮，以确认按钮是否已被释放。

中文

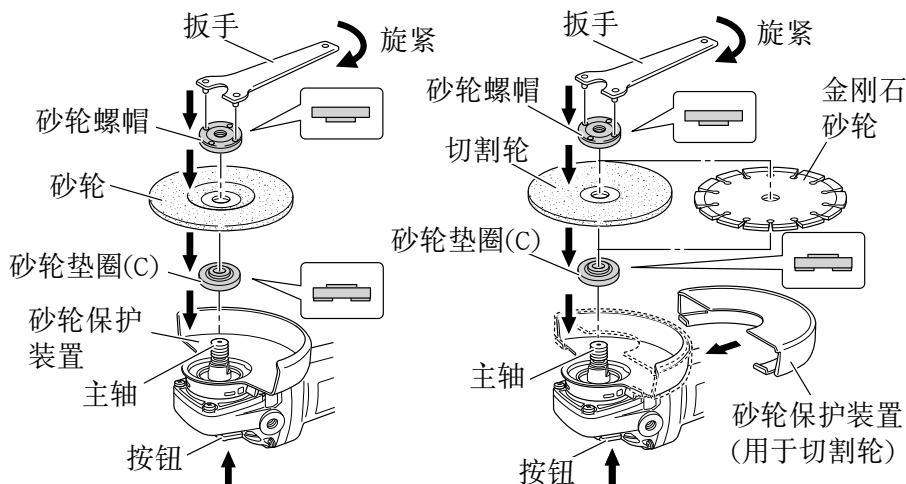
2. 拆卸

如需拆卸钹形砂轮，只需按照与上述相反的步骤操作即可。

请按照与钹形砂轮相同的方式，安装或者拆卸金刚石砂轮或者切割轮。

维护和检查

警告！

在维护和检查期间，一定要“切断”电源，并将插座上的插头拔掉。

1. 检查砂轮

检查砂轮确无破裂和表面缺陷。

2. 检查安装螺钉

要经常检查安装螺钉是否紧固妥善。若发现螺钉松了，应立即重新扭紧，否则会导致严重的事故。

3. 检查炭刷

为了保证长期的安全使用以及避免触电事故的发生，本工具的炭刷检查与更换只能由 HiKOKI 授权的服务中心进行。

4. 电动机的维护

电动机绕线是电动工具的“心脏”。应仔细检查有无损伤，是否被油液或水沾湿。

注：

每使用约 50 个小时后，请在空载运行电机的同时，卸下过滤器并使用吹风枪通过气孔吹入干空气。这样可以除净灰尘或污垢。（图 8）

请注意，电机内部积聚的尘垢可能会导致故障。

5. 更换电源线

必须更换电源线时，应由 HiKOKI 公司授权的维修中心来更换，以避免安全隐患。

本电动工具的电源线损坏时必须更换成由维修组织特别准备的电源线。



图 8

选择附件

有关详细信息请联系 HIKOKI 授权服务中心。

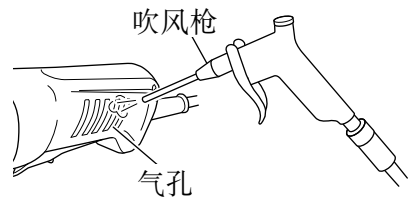
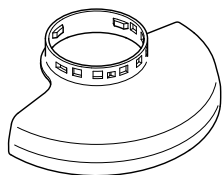

产品编号：375907

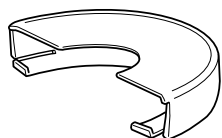

产品编号：372701



产品编号：376067

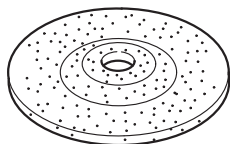

产品编号：339579

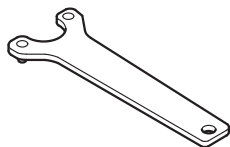

产品编号：938332Z

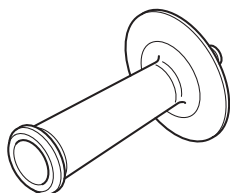

产品编号：302142

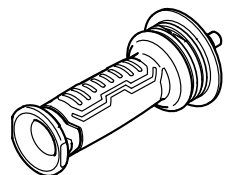

产品编号：336865

CONTENTS

GENERAL POWER TOOL SAFETY WARNINGS	14
SAFETY WARNINGS COMMON FOR GRINDING OR ABRASIVE CUTTING-OFF OPERATIONS	17
KICKBACK AND RELATED WARNINGS	18
SAFETY WARNINGS SPECIFIC FOR GRINDING OPERATIONS.....	19
GENERAL SAFETY INSTRUCTIONS FOR GRINDERS	20
SYMBOLS	21
SPECIFICATIONS	21
STANDARD ACCESSORIES	21
APPLICATIONS.....	22
PRIOR TO OPERATION.....	22
PRACTICAL GRINDER APPLICATION.....	23
ASSEMBLING AND DISASSEMBLING THE DEPRESSED CENTER WHEEL.....	25
MAINTENANCE AND INSPECTION	26
SELECTING ACCESSORIES.....	27

GENERAL POWER TOOL SAFETY WARNINGS

WARNING

Read all safety warnings and all instructions.

Failure to follow the warnings and instructions may result in electric shock, fire and/or serious injury.

Save all warnings and instructions for future reference.

The term “power tool” in the warnings refers to your mains-operated (corded) power tool or battery-operated (cordless) power tool.

- 1) **Work area safety**
 - a) **Keep work area clean and well lit.**
Cluttered or dark areas invite accidents.
 - b) **Do not operate power tools in explosive atmospheres, such as in the presence of flammable liquids, gases or dust.**
Power tools create sparks which may ignite the dust or fumes.
 - c) **Keep children and bystanders away while operating a power tool.**
Distractions can cause you to lose control.

- 2) **Electrical safety**
 - a) **Power tool plugs must match the outlet.**
Never modify the plug in any way.
Do not use any adapter plugs with earthed (grounded) power tools.
Unmodified plugs and matching outlets will reduce risk of electric shock.

- b) **Avoid body contact with earthed or grounded surfaces, such as pipes, radiators, ranges and refrigerators.**
There is an increased risk of electric shock if your body is earthed or grounded.
- c) **Do not expose power tools to rain or wet conditions.**
Water entering a power tool will increase the risk of electric shock.
- d) **Do not abuse the cord. Never use the cord for carrying, pulling or unplugging the power tool.**
Keep cord away from heat, oil, sharp edges or moving parts.
Damaged or entangled cords increase the risk of electric shock.
- e) **When operating a power tool outdoors, use an extension cord suitable for outdoor use.**
Use of a cord suitable for outdoor use reduces the risk of electric shock.
- f) **If operating a power tool in a damp location is unavoidable, use a residual current device (RCD) protected supply.**
Use of an RCD reduces the risk of electric shock.

3) Personal safety

- a) **Stay alert, watch what you are doing and use common sense when operating a power tool.**
Do not use a power tool while you are tired or under the influence of drugs, alcohol or medication.
A moment of inattention while operating power tools may result in serious personal injury.
- b) **Use personal protective equipment. Always wear eye protection.**
Protective equipment such as dust mask, non-skid safety shoes, hard hat, or hearing protection used for appropriate conditions will reduce personal injuries.
- c) **Prevent unintentional starting. Ensure the switch is in the off position before connecting to power source and/or battery pack, picking up or carrying the tool.**
Carrying power tools with your finger on the switch or energising power tools that have the switch on invites accidents.
- d) **Remove any adjusting key or wrench before turning the power tool on.**
A wrench or a key left attached to a rotating part of the power tool may result in personal injury.
- e) **Do not overreach. Keep proper footing and balance at all times.**
This enables better control of the power tool in unexpected situations.
- f) **Dress properly. Do not wear loose clothing or jewellery. Keep your hair, clothing and gloves away from moving parts.**
Loose clothes, jewellery or long hair can be caught in moving parts.
- g) **If devices are provided for the connection of dust extraction and collection facilities, ensure these are connected and properly used.**
Use of dust collection can reduce dust-related hazards.

English

4) Power tool use and care

- a) **Do not force the power tool. Use the correct power tool for your application.**
The correct power tool will do the job better and safer at the rate for which it was designed.
- b) **Do not use the power tool if the switch does not turn it on and off.**
Any power tool that cannot be controlled with the switch is dangerous and must be repaired.
- c) **Disconnect the plug from the power source and/or the battery pack from the power tool before making any adjustments, changing accessories, or storing power tools.**
Such preventive safety measures reduce the risk of starting the power tool accidentally.
- d) **Store idle power tools out of the reach of children and do not allow persons unfamiliar with the power tool or these instructions to operate the power tool.**
Power tools are dangerous in the hands of untrained users.
- e) **Maintain power tools. Check for misalignment or binding of moving parts, breakage of parts and any other condition that may affect the power tool's operation.**
If damaged, have the power tool repaired before use.
Many accidents are caused by poorly maintained power tools.
- f) **Keep cutting tools sharp and clean.**
Properly maintained cutting tools with sharp cutting edges are less likely to bind and are easier to control.
- g) **Use the power tool, accessories and tool bits etc. in accordance with these instructions, taking into account the working conditions and the work to be performed.**
Use of the power tool for operations different from those intended could result in a hazardous situation.

5) Service

- a) **Have your power tool serviced by a qualified repair person using only identical replacement parts.**
This will ensure that the safety of the power tool is maintained.

PRECAUTION

Keep children and infirm persons away.

When not in use, tools should be stored out of reach of children and infirm persons.

SAFETY WARNINGS COMMON FOR GRINDING OR ABRASIVE CUTTING-OFF OPERATIONS

- a) **This power tool is intended to function as a grinder or cut-off tool. Read all safety warnings, instructions, illustrations and specifications provided with this power tool.**
Failure to follow all instructions listed below may result in electric shock, fire and/or serious injury.
- b) **Operations such as sanding, wire brushing, polishing are not recommended to be performed with this power tool.**
Operations for which the power tool was not designed may create a hazard and cause personal injury.
- c) **Do not use accessories which are not specifically designed and recommended by the tool manufacturer.**
Just because the accessory can be attached to your power tool, it does not assure safe operation.
- d) **The rated speed of the accessory must be at least equal to the maximum speed marked on the power tool.**
Accessories running faster than their rated speed can break and fly apart.
- e) **The outside diameter and the thickness of your accessory must be within the capacity rating of your power tool.**
Incorrectly sized accessories cannot be adequately guarded or controlled.
- f) **Threaded mounting of accessories must match the grinder spindle thread. For accessories mounted by flanges, the arbour hole of the accessory must fit the locating diameter of the flange.**
Accessories that do not match the mounting hardware of the power tool will run out of balance, vibrate excessively and may cause loss of control.
- g) **Do not use a damaged accessory. Before each use inspect the accessory such as abrasive wheels for chips and cracks, backing pad for cracks, tear or excess wear, wire brush for loose or cracked wires. If power tool or accessory is dropped, inspect for damage or install an undamaged accessory. After inspecting and installing an accessory, position yourself and bystanders away from the plane of the rotating accessory and run the power tool at maximum no-load speed for one minute.**
Damaged accessories will normally break apart during this test time.
- h) **Wear personal protective equipment. Depending on application, use face shield, safety goggles or safety glasses. As appropriate, wear dust mask, hearing protectors, gloves and workshop apron capable of stopping small abrasive or workpiece fragments.**
The eye protection must be capable of stopping flying debris generated by various operations. The dust mask or respirator must be capable of filtering particles generated by your operation. Prolonged exposure to high intensity noise may cause hearing loss.

English

- i) **Keep bystanders a safe distance away from work area. Anyone entering the work area must wear personal protective equipment.**
Fragments of workpiece or of a broken accessory may fly away and cause injury beyond immediate area of operation.
- j) **Hold the power tool by insulated gripping surfaces only, when performing an operation where the cutting accessory may contact hidden wiring or its own cord.**
Cutting accessory contacting a "live" wire may make exposed metal parts of the power tool "live" and could give the operator an electric shock.
- k) **Position the cord clear of the spinning accessory.**
If you lose control, the cord may be cut or snagged and your hand or arm may be pulled into the spinning accessory.
- l) **Never lay the power tool down until the accessory has come to a complete stop.**
The spinning accessory may grab the surface and pull the power tool out of your control.
- m) **Do not run the power tool while carrying it at your side.**
Accidental contact with the spinning accessory could snag your clothing, pulling the accessory into your body.
- n) **Regularly clean the power tool's air vents.**
The motor's fan will draw the dust inside the housing and excessive accumulation of powdered metal may cause electrical hazards.
- o) **Do not operate the power tool near flammable materials.**
Sparks could ignite these materials.
- p) **Do not use accessories that require liquid coolants.**
Using water or other liquid coolants may result in electrocution or shock.

KICKBACK AND RELATED WARNINGS

Kickback is a sudden reaction to a pinched or snagged rotating wheel, backing pad, brush or any other accessory. Pinching or snagging causes rapid stalling of the rotating accessory which in turn causes the uncontrolled power tool to be forced in the direction opposite of the accessory's rotation at the point of the binding.

For example, if an abrasive wheel is snagged or pinched by the workpiece, the edge of the wheel that is entering into the pinch point can dig into the surface of the material causing the wheel to climb out or kick out. The wheel may either jump toward or away from the operator, depending on direction of the wheel's movement at the point of pinching.

Abrasive wheels may also break under these conditions.

Kickback is the result of power tool misuse and/or incorrect operating procedures or conditions and can be avoided by taking proper precautions as given below.

- a) **Maintain a firm grip on the power tool and position your body and arm to allow you to resist kickback forces. Always use auxiliary handle, if provided, for maximum control over kickback or torque reaction during start-up.**
The operator can control torque reactions or kickback forces, if proper precautions are taken.
- b) **Never place your hand near the rotating accessory.**
Accessory may kickback over your hand.

- c) **Do not position your body in the area where power tool will move if kickback occurs.**
Kickback will propel the tool in direction opposite to the wheel's movement at the point of snagging.
- d) **Use special care when working corners, sharp edges etc. Avoid bouncing and snagging the accessory.**
Corners, sharp edges or bouncing have a tendency to snag the rotating accessory and cause loss of control or kickback.
- e) **Do not attach a saw chain woodcarving blade or toothed saw blade.**
Such blades create frequent kickback and loss of control.

SAFETY WARNINGS SPECIFIC FOR GRINDING OPERATIONS

- a) **Use only wheel types that are recommended for your power tool and the specific guard designed for the selected wheel.**
Wheels for which the power tool was not designed cannot be adequately guarded and are unsafe.
- b) **The grinding surface of centre depressed wheels must be mounted below the plane of the guard lip.**
An improperly mounted wheel that projects through the plane of the guard lip cannot be adequately protected.
- c) **The guard must be securely attached to the power tool and positioned for maximum safety, so the least amount of wheel is exposed towards the operator.**
The guard helps to protect the operator from broken wheel fragments, accidental contact with wheel and sparks that could ignite clothing.
- d) **Wheels must be used only for recommended applications. For example: do not grind with the side of cut-off wheel.**
Abrasive cut-off wheels are intended for peripheral grinding, side forces applied to these wheels may cause them to shatter.
- e) **Always use undamaged wheel flanges that are of correct size and shape for your selected wheel.**
Proper wheel flanges support the wheel thus reducing the possibility of wheel breakage. Flanges for cut-off wheels may be different from grinding wheel flanges.
- f) **Do not use worn down wheels from larger power tools.**
Wheel intended for larger power tool is not suitable for the higher speed of a smaller tool and may burst.

GENERAL SAFETY INSTRUCTIONS FOR GRINDERS

- Check that speed marked on the wheel is equal to or greater than the rated speed of the grinder;
- Ensure that the wheel dimensions are compatible with the grinder;
- Abrasive wheels shall be stored and handled with care in accordance with manufacturer's instructions;
- Inspect the grinding wheel before use, do not use chipped, cracked or otherwise defective products;
- Ensure that mounted wheels and points are fitted in accordance with the manufacturer's instructions;
- Ensure that blotters are used when they are provided with the bonded abrasive product and when they are required;
- Ensure that the abrasive product is correctly mounted and tightened before use and run the tool at no-load for 30 seconds in a safe position, stop immediately if there is considerable vibration or if other defects are detected. If this condition occurs, check the machine to determine the cause;
- If a guard is equipped with the tool never use the tool without such a guard;
- When using an abrasive cutting wheel, be sure to attach the wheel guard for cutting wheel (sold separately) over the standard-accessory wheel guard. (Fig. 1);
- Do not use separate reducing bushings or adapters to adapt large hole abrasive wheels;
- For tools intended to be fitted with threaded hole wheel, ensure that the thread in the wheel is long enough to accept the spindle length;
- Check that the work piece is properly supported;
- Do not use cutting off wheel for side grinding;
- Ensure that sparks resulting from use do not create a hazard e.g. do not hit persons, or ignite flammable substances;
- Ensure that ventilation openings are kept clear when working in dusty conditions, if it should become necessary to clear dust, first disconnect the tool from the mains supply (use non metallic objects) and avoid damaging internal parts;
- Always use eye and ear protection. Other personal protective equipment such as dust mask, gloves, helmet and apron should be worn;
- Pay attention to the wheel that continues to rotate after the tool is switched off.

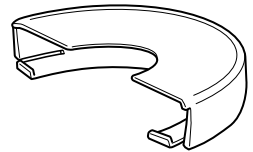





Fig. 1

SYMBOLS

WARNING

The following show symbols used for the machine. Be sure that you understand their meaning before use.

	To reduce the risk of injury, user must read instruction manual.
	Always wear eye protection.
	Class II tool

SPECIFICATIONS

Model	G13SE3	
Voltage	220 V ~	
Power Input	1300 W	
Rated speed	11500 /min	
Wheel	Outer dia. x thickness x hole dia.	125 x 6 x 22.23 mm
	Peripheral speed	80 m/s
Weight (Only main body)	2.5 kg	

STANDARD ACCESSORIES

See the list below to check the accessories for G13SE3.

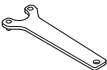
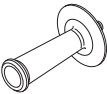
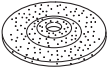
		G13SE3
Wrench		1
Side handle		1
Depressed center wheel		1

APPLICATIONS

- Removal of casting fin and finishing of various types of steel, bronze and aluminum materials and castings.
- Grinding of welded sections or sections cut by means of a cutting torch.

PRIOR TO OPERATION

1. Power source
Ensure that the power source to be utilized conforms to the power requirements specified on the product nameplate.
2. Power switch
Ensure that the power switch is in the OFF position. If the plug is connected to a receptacle while the power switch is in the ON position, the power tool will start operating immediately, which could cause a serious accident.
3. Extension cord
When the work area is removed from the power source, use an extension cord of sufficient thickness and rated capacity. The extension cord should be kept as short as practicable.
4. Fitting and adjusting the wheel guard (**Fig. 2**)
The wheel guard is a protective device to prevent injury should the depressed center wheel shatter during operation. Ensure that the guard is properly fitted and fastened before commencing grinding operation. By slightly loosening the setting screw, the wheel guard can be turned and set at any desired angle for maximum operational effectiveness. Ensure that the setting screw is thoroughly tightened after adjusting the wheel guard.
5. Ensure that mounted wheels and points are fitted in accordance with the manufacturer's instructions.
Ensure that the depressed center wheel to be utilized is the correct type and free of cracks or surface defects. Also ensure that the depressed center wheel is properly mounted and the wheel nut is securely tightened, Refer to the section on "ASSEMBLING AND DISASSEMBLING THE DEPRESSED CENTER WHEEL".
Ensure that blotters are used when they are provided with the bonded abrasive product and when they are required.
Do not use separate reducing bushings or adaptors to adapt large hole abrasive wheels.
For tools intended to be fitted with threaded hole wheel, ensure that the thread in the wheel is long enough to accept the spindle length.
Do not use cutting off wheel for side grinding.

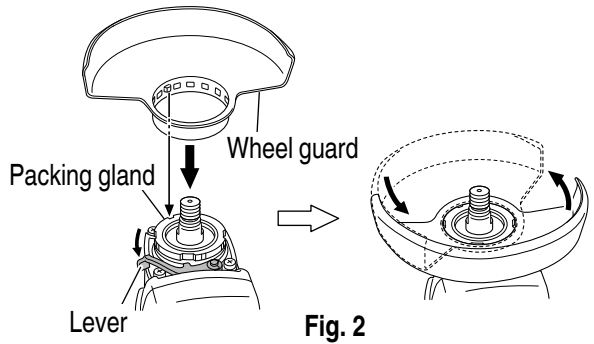

6. Test the grinder before using.
Before actually beginning the grinding work, test the grinder by first clearing the area of all other personnel. Make sure the wheel guard is in place and that you are wearing eye protection. Turn the grinder “on”, and make sure the grinder runs smoothly and shows no abnormalities.

Duration of the trial run is as follows:

When depressed center wheel is replaced3 minutes or more

When starting daily work1 minute or more

7. Check the push button.
Make sure that the push button is disengaged by pushing push button two or three times before turning on the grinder. **(Fig. 3)**

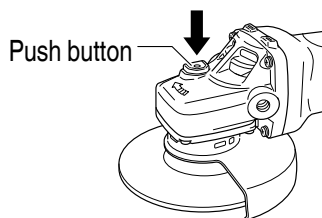

Fig. 3

8. Fixing the side handle
Screw the side handle into the gear cover **(Fig. 4)**.

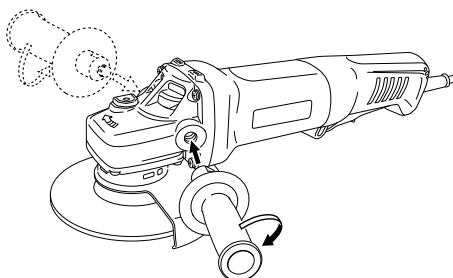

Fig. 4

PRACTICAL GRINDER APPLICATION

1. Switch operation

[When the switch has locking mechanism]

Switch ON: To switch on, slide the OFF lock lever in the direction of **(A)** and press the paddle lever in the direction of **(B)** as shown in **Fig. 5-a**.

Furthermore, slide the ON lock lever in the direction of **(C)** shown in **Fig.5-b** while pressing the paddle lever to lock and enable continuous operation.

Switch OFF: To release the locking mode, press the paddle lever in the direction of **(B)** shown in **Fig.5-a**, and release the paddle lever to switch off.

[When the switch has no locking mechanism]

To switch on, slide the lock lever in the direction of **(A)** and press the paddle lever in the direction of **(B)** as shown in **Fig. 5-a**. Release the paddle lever to switch off.

NOTE

The paddle lever can not be locked.

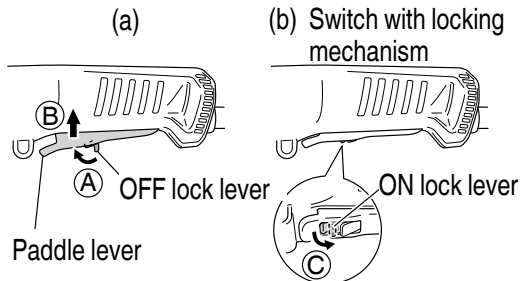

Fig. 5

English

2. Pressure

To prolong the life of the machine and ensure a first class finish, it is important that the machine should not be overloaded by applying too much pressure. In most applications, the weight of the machine alone is sufficient for effective grinding. Too much pressure will result in reduced rotational speed, inferior surface finish, and overloading which could reduce the life of the machine.

3. Grinding angle

Do not apply the entire surface of the depressed center wheel to the material to be ground. As shown in **Fig. 6**, the machine should be held at an angle of 15° – 30° so that the external edge of the depressed center wheel contacts the material at an optimum angle.

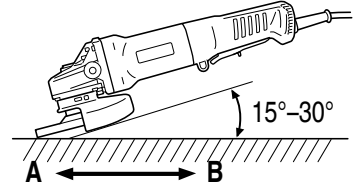

Fig. 6

4. To prevent a new depressed center wheel from digging into the workpiece, initial grinding should be performed by drawing the grinder across the workpiece toward the operator (**Fig. 6 direction B**).

Once the leading edge of the depressed center wheel is properly abraded, grinding may be conducted in either direction.

5. Precautions immediately after finishing operation

The wheel continues to rotate after the tool is switched off.

After switching off the machine, do not put it down until the depressed center wheel has come to a complete stop. Apart from avoiding serious accidents, this precaution will reduce the amount of dust and swarf sucked into the machine.

CAUTION

- **Check that the work piece is properly supported.**
- **Ensure that ventilation openings are kept clear when working in dusty conditions. If it should become necessary to clear dust, first disconnect the tool from the mains supply (use non-metallic objects) and avoid damaging internal parts.**
- **Ensure that sparks resulting from use do not create a hazard e.g. do not hit persons, or ignite flammable substances.**
- **Always use eye and ear protection.**
- **Other personal protective equipment such as dust mask, gloves, helmet and apron should be worn when necessary.**
- **If in doubt, wear the protective equipment.**
- **When the machine is not use, the power source should be disconnected.**

ASSEMBLING AND DISASSEMBLING THE DEPRESSED CENTER WHEEL (Fig. 7)

CAUTION

Be sure to switch OFF and disconnect the attachment plug from the receptacle to avoid a serious accident.

1. Assembling

- (1) Turn the disc grinder upsidedown so that the spindle is facing upward.
- (2) Align the across flats of the wheel washer (C) with the notched part of the spindle, then attach them.
- (3) Fit the protuberance of the depressed center wheel onto the wheel washer (C).
- (4) Screw the wheel nut onto the spindle.
- (5) While pushing the push button with one hand, lock the spindle by turning the depressed center wheel slowly with the other hand.

Tighten the wheel nut by using the supplied wrench as shown in **Fig. 7**.

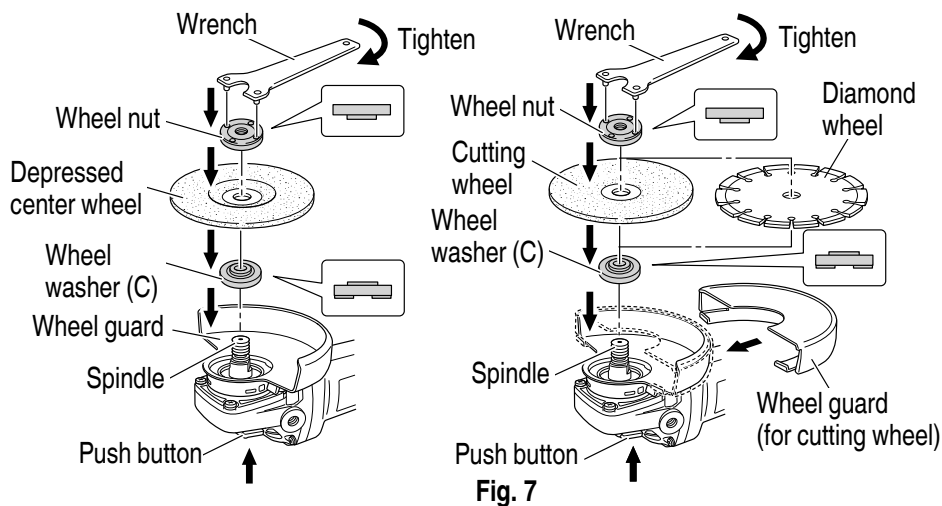

CAUTION

- Confirm that the depressed center wheel is mounted firmly.
- Confirm that the push button is disengaged by pushing push button two or three times before switching the power tool on.

2. Disassembly

To remove the depressed center wheel, simply reverse the above-mentioned procedure.

Attach or detach the diamond wheel or cutting wheel in the same manner as the depressed center wheel.

MAINTENANCE AND INSPECTION

WARNING

Be sure to switch power OFF and disconnect the plug from the receptacle during maintenance and inspection.

1. Inspecting the depressed center wheel
Ensure that the depressed center wheel is free of cracks and surface defects.
2. Inspecting the mounting screws
Regularly inspect all mounting screws and ensure that they are properly tightened. Should any of the screws be loose, retighten them immediately. Failure to do so could result in serious hazard.
3. Inspecting the carbon brushes
For your continued safety and electrical shock protection, carbon brush inspection and replacement on this tool should **ONLY** be performed by a HiKOKI Authorized Service Center.
4. Maintenance of the motor
The motor unit winding is the very “heart” of the power tool. Exercise due care to ensure the winding does not become damaged and/or wet with oil or water.

NOTE

After every approximately 50 hours of use, remove the filter and use an air blow gun to blow dry air through the air holes while running the motor with no load. This will eliminate or remove any dirt or dust. **(Fig. 8)**

Note that accumulated dirt or dust inside the motor may result in malfunctions.

5. Replacing supply cord
If the replacement of the supply cord is necessary, this has to be done by HiKOKI Authorized Service Center in order to avoid a safety hazard.
If the supply cord of this power tool is damaged, it must be replaced by a specially prepared cord available through the service organization.

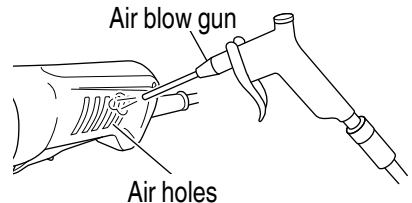
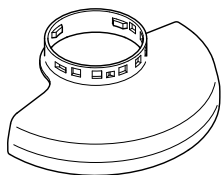

Fig. 8

SELECTING ACCESSORIES

For details contact HiKOKI Authorized Service Center.



Part Number: 375907

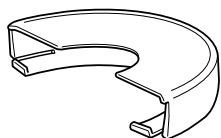

Part Number: 372701



Part Number: 376067

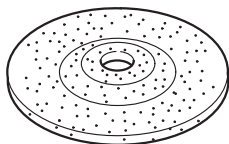

Part Number: 339579

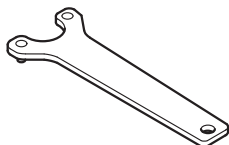

Part Number: 938332Z

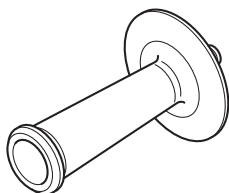

Part Number: 302142

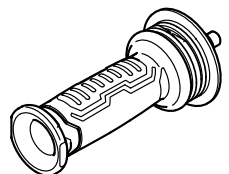

Part Number: 336865

服务中心
高壹工机商业(上海)有限公司
上海市闵行区浦江工业园区三鲁路3585号7幢3楼

制造商
福建高壹工机有限公司
福建省福州市福兴投资区湖塘路

Koki Holdings Co., Ltd.

204
编号: C99736821 F
发行日期: 2022年 4月
中国印刷