

HIKOKI

M 18DYA

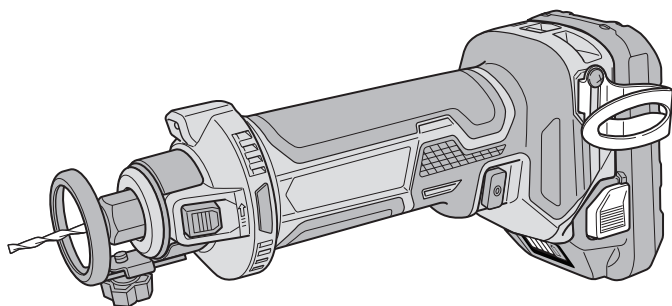

Handling instructions

1

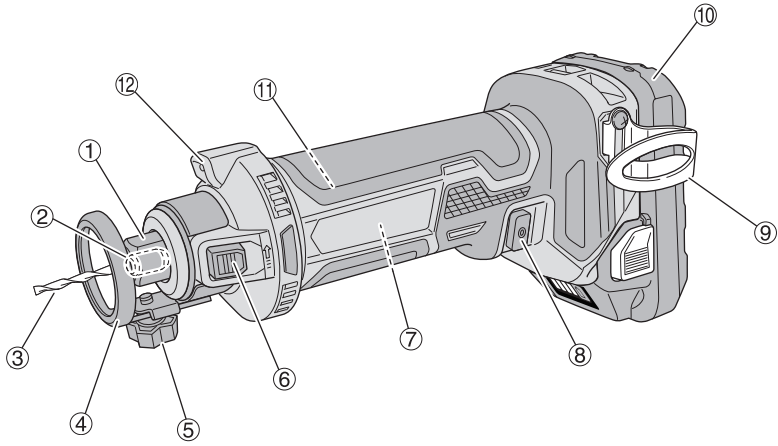

2

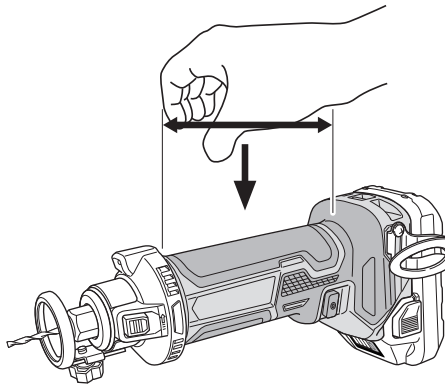

3

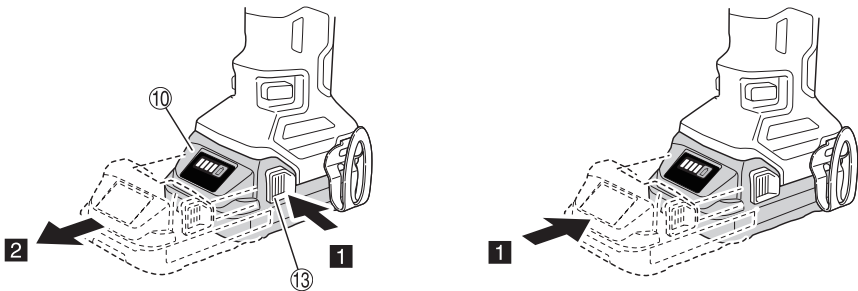

4

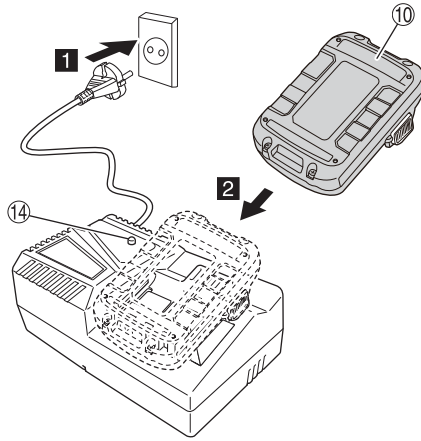

5



O

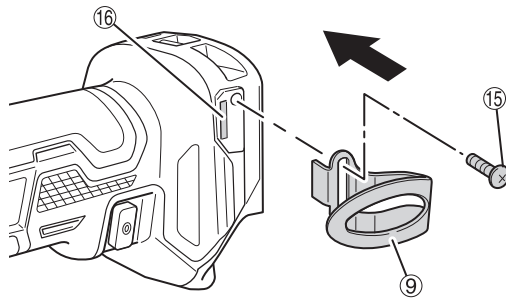

6



O

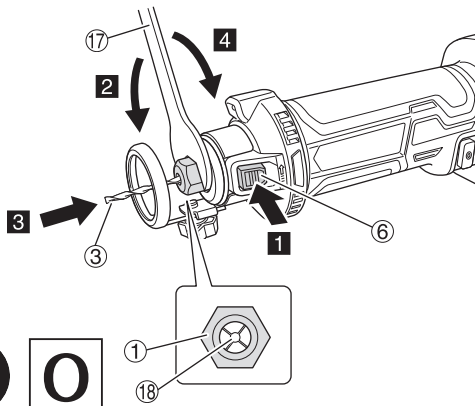

7

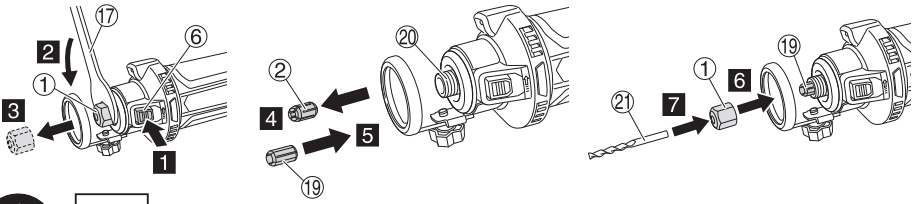

O

8

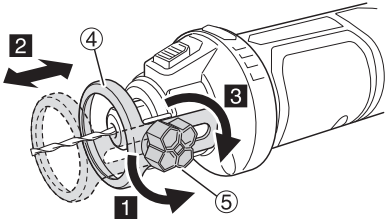

O

9

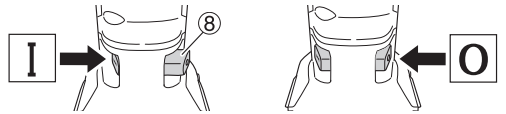

10

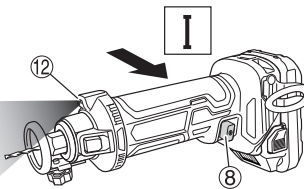

11

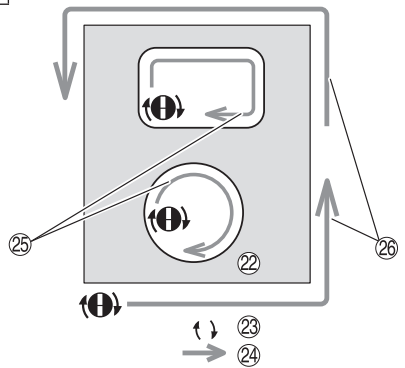

12

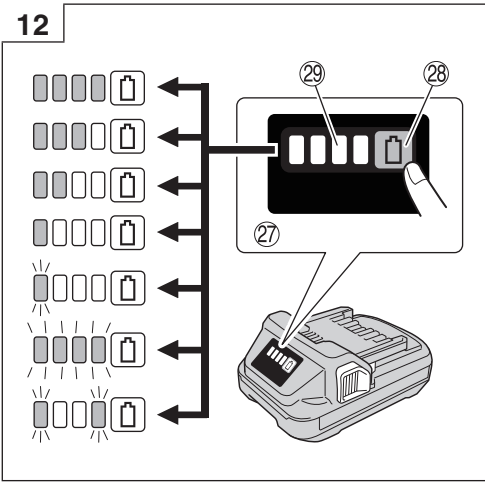

13

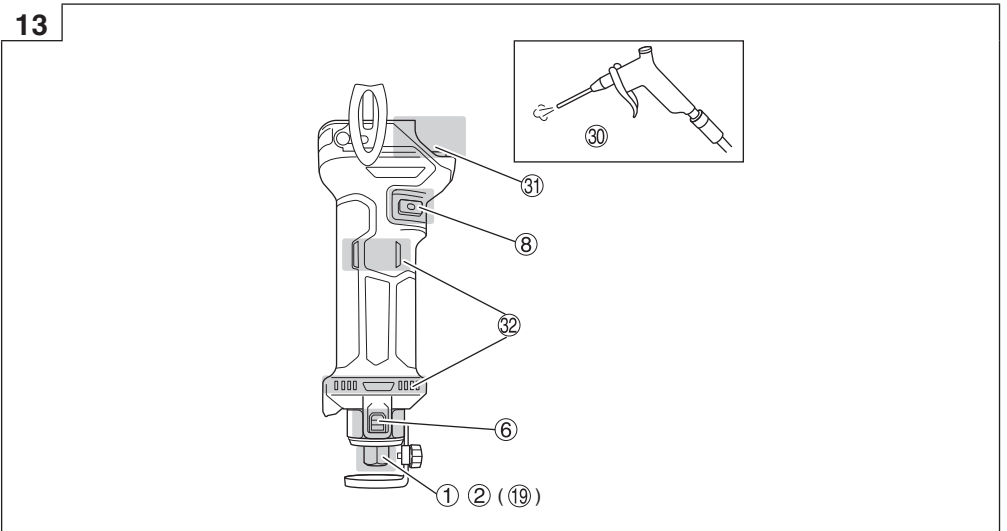

GENERAL POWER TOOL SAFETY WARNINGS

WARNING

Read all safety warnings, instructions, illustrations and specifications provided with this power tool.

Failure to follow all instructions listed below may result in electric shock, fire and/or serious injury.

Save all warnings and instructions for future reference.

The term "power tool" in the warnings refers to your mains-operated (corded) power tool or battery-operated (cordless) power tool.

1) Work area safety

- a) **Keep work area clean and well lit.**
Cluttered or dark areas invite accidents.
- b) **Do not operate power tools in explosive atmospheres, such as in the presence of flammable liquids, gases or dust.**
Power tools create sparks which may ignite the dust or fumes.
- c) **Keep children and bystanders away while operating a power tool.**
Distractions can cause you to lose control.

2) Electrical safety

- a) **Power tool plugs must match the outlet. Never modify the plug in any way. Do not use any adapter plugs with earthed (grounded) power tools.**
Unmodified plugs and matching outlets will reduce risk of electric shock.
- b) **Avoid body contact with earthed or grounded surfaces, such as pipes, radiators, ranges and refrigerators.**
There is an increased risk of electric shock if your body is earthed or grounded.
- c) **Do not expose power tools to rain or wet conditions.**
Water entering a power tool will increase the risk of electric shock.
- d) **Do not abuse the cord. Never use the cord for carrying, pulling or unplugging the power tool. Keep cord away from heat, oil, sharp edges or moving parts.**
Damaged or entangled cords increase the risk of electric shock.
- e) **When operating a power tool outdoors, use an extension cord suitable for outdoor use.**
Use of a cord suitable for outdoor use reduces the risk of electric shock.
- f) **If operating a power tool in a damp location is unavoidable, use a residual current device (RCD) protected supply.**
Use of an RCD reduces the risk of electric shock.

3) Personal safety

- a) **Stay alert, watch what you are doing and use common sense when operating a power tool. Do not use a power tool while you are tired or under the influence of drugs, alcohol or medication.**
A moment of inattention while operating power tools may result in serious personal injury.
- b) **Use personal protective equipment. Always wear eye protection.**
Protective equipment such as a dust mask, non-skid safety shoes, hard hat or hearing protection used for appropriate conditions will reduce personal injuries.

- c) **Prevent unintentional starting. Ensure the switch is in the off-position before connecting to power source and/or battery pack, picking up or carrying the tool.**

Carrying power tools with your finger on the switch or energising power tools that have the switch on invites accidents.

- d) **Remove any adjusting key or wrench before turning the power tool on.**
A wrench or a key left attached to a rotating part of the power tool may result in personal injury.
 - e) **Do not overreach. Keep proper footing and balance at all times.**
This enables better control of the power tool in unexpected situations.
 - f) **Dress properly. Do not wear loose clothing or jewellery. Keep your hair and clothing away from moving parts.**
Loose clothes, jewellery or long hair can be caught in moving parts.
 - g) **If devices are provided for the connection of dust extraction and collection facilities, ensure these are connected and properly used.**
Use of dust collection can reduce dust-related hazards.
 - h) **Do not let familiarity gained from frequent use of tools allow you to become complacent and ignore tool safety principles.**
A careless action can cause severe injury within a fraction of a second.
- #### 4) Power tool use and care
- a) **Do not force the power tool. Use the correct power tool for your application.**
The correct power tool will do the job better and safer at the rate for which it was designed.
 - b) **Do not use the power tool if the switch does not turn it on and off.**
Any power tool that cannot be controlled with the switch is dangerous and must be repaired.
 - c) **Disconnect the plug from the power source and/or remove the battery pack, if detachable, from the power tool before making any adjustments, changing accessories, or storing power tools.**
Such preventive safety measures reduce the risk of starting the power tool accidentally.
 - d) **Store idle power tools out of the reach of children and do not allow persons unfamiliar with the power tool or these instructions to operate the power tool.**
Power tools are dangerous in the hands of untrained users.
 - e) **Maintain power tools and accessories. Check for misalignment or binding of moving parts, breakage of parts and any other condition that may affect the power tool's operation. If damaged, have the power tool repaired before use.**
Many accidents are caused by poorly maintained power tools.
 - f) **Keep cutting tools sharp and clean.**
Properly maintained cutting tools with sharp cutting edges are less likely to bind and are easier to control.
 - g) **Use the power tool, accessories and tool bits etc. in accordance with these instructions, taking into account the working conditions and the work to be performed.**
Use of the power tool for operations different from those intended could result in a hazardous situation.
 - h) **Keep handles and grasping surfaces dry, clean and free from oil and grease.**
Slippery handles and grasping surfaces do not allow for safe handling and control of the tool in unexpected situations.

5) Battery tool use and care

- a) **Recharge only with the charger specified by the manufacturer.**

A charger that is suitable for one type of battery pack may create a risk of fire when used with another battery pack.

- b) **Use power tools only with specifically designated battery packs.**

Use of any other battery packs may create a risk of injury and fire.

- c) **When battery pack is not in use, keep it away from other metal objects, like paper clips, coins, keys, nails, screws or other small metal objects, that can make a connection from one terminal to another.**

Shorting the battery terminals together may cause burns or a fire.

- d) **Under abusive conditions, liquid may be ejected from the battery; avoid contact. If contact accidentally occurs, flush with water. If liquid contacts eyes, additionally seek medical help.**

Liquid ejected from the battery may cause irritation or burns.

- e) **Do not use a battery pack or tool that is damaged or modified.**

Damaged or modified batteries may exhibit unpredictable behaviour resulting in fire, explosion or risk of injury.

- f) **Do not expose a battery pack or tool to fire or excessive temperature.**

Exposure to fire or temperature above 130°C may cause explosion.

- g) **Follow all charging instructions and do not charge the battery pack or tool outside the temperature range specified in the instructions.**

Charging improperly or at temperatures outside the specified range may damage the battery and increase the risk of fire.

6) Service

- a) **Have your power tool serviced by a qualified repair person using only identical replacement parts.**

This will ensure that the safety of the power tool is maintained.

- b) **Never service damaged battery packs.**

Service of battery packs should only be performed by the manufacturer or authorized service providers.

PRECAUTION

Keep children and infirm persons away.

When not in use, tools should be stored out of reach of children and infirm persons.

CORDLESS CUT-OUT TOOL SAFETY WARNINGS

1. **Hold the power tool by insulated gripping surfaces, when performing an operation where the cutting accessory may contact hidden wiring.**

Cutting accessory contacting a "live" wire may make exposed metal parts of the power tool "live" and could give the operator an electric shock.

2. **Use clamps or another practical way to secure and support the workpiece to a stable platform.**

Holding the work by your hand or against the body leaves it unstable and may lead to loss of control.

ADDITIONAL SAFETY WARNINGS

- Preparing and checking the work environment. Make sure that the work site meets all the conditions laid forth in the precautions.
- Before starting work, ensure that there are no buried objects such as electrical conduits, water pipes, or gas pipes in the work area.
If there is a buried object, the bit may touch it, resulting in electric shock, leakage of electricity, or leakage of gas, which may cause an accident.
- Make sure there are no obstructions under the material to be cut.
A strong repulsive force may occur, causing injury.
- Use bits of the correct shank diameter suitable for the speed of the tool.
- Handle the bits very carefully.
- Check the bit carefully for cracks or damage before operation. Replace cracked or damaged bit immediately.
- Avoid cutting nails. Inspect for and remove all nails from the workpiece before operation.
- Make sure to securely hold the tool during operation. Failure to do so can result in accidents or injuries. (Fig. 2)
- Always switch off and wait for the bit to come to a complete stop before removing the tool from workpiece.
- After changing the bits or making any adjustments, make sure the collet nut and any other adjustment device are securely tightened.
Loose adjustment device can unexpectedly shift, causing loss of control, loose rotating components will be violently thrown.
- Never touch moving parts.
Never place your hands, fingers or other body parts near the tool's moving parts.
- Do not perform any operation using your hands to support or guide the workpiece.
- Always use with the depth guide securely attached to the tool and positioned flat and firmly against the workpiece.
- Do not use this tool for drilling.
- NEVER leave tool running unattended. Turn power off.
Don't leave tool until it comes to a complete stop.
- The bit and shaft, collet nut, collet are very hot immediately after operation. Avoid bare hand contact with the bit for any reason.
- The power tool is equipped with a temperature protection circuit to protect the motor. Continuous work may cause the temperature of the unit to rise, activating the temperature protection circuit and automatically stopping operation. If this happens, allow the power tool to cool before resuming use.
- Install securely the hook. Unless the hook is securely installed, it may cause an injury while using.
When electing to carry the tool hooked to your hip belt, make sure to detach the tool bit. Failure to do so may result in unexpected injury.
- Do not look directly into the light. Such actions could result in eye injury.
Wipe off any dirt or grime attached to the lens of the LED light with a soft cloth, being careful not to scratch the lens.
Scratches on the lens of the LED light can result in decreased brightness.
- Always charge the battery at a temperature of 0°C–40°C. A temperature of less than 0°C will result in over charging which is dangerous. The battery cannot be charged at a temperature higher than 40°C.
The most suitable temperature for charging is that of 20°C–25°C.
- Do not use the charger continuously.
When one charging is completed, leave the charger for about 15 minutes before the next charging of battery.

22. Do not allow foreign matter to enter the hole for connecting the rechargeable battery.
23. Never disassemble the rechargeable battery and charger.
24. Never short-circuit the rechargeable battery. Shortcircuiting the battery will cause a great electric current and overheat. It results in burn or damage to the battery.
25. Do not dispose of the battery in fire. If the battery is burnt, it may explode.
26. Bring the battery to the shop from which it was purchased as soon as the post-charging battery life becomes too short for practical use. Do not dispose of the exhausted battery.
27. Do not insert object into the air ventilation slots of the charger. Inserting metal objects or inflammables into the charger air ventilation slots will result in electrical shock hazard or damaged charger.
28. When using this unit continuously, the unit may overheat, leading to damage in the motor and switch. Therefore, whenever the housing becomes hot, give the tool a break for a while.
29. If the machine is used continuously at low speed, an extra load is applied to the motor which can result in motor seizure. Always operate the power tool so that the bit is not caught by the material during operation. Always adjust the bit speed to enable smooth cutting.
30. Make sure that the battery is installed firmly. If it is at all loose it could come off and cause an accident.
31. When operating the tool, do not wear work gloves as such cloth wear can get caught in the tool.
32. Always use the tool and battery at temperatures between -5°C and 40°C.
33. Do not use the product if the tool or the battery terminals (battery mount) are deformed. Installing the battery could cause a short circuit that could result in smoke emission or ignition.
34. Keep the tool's terminals (battery mount) free of swarf and dust.
 - Prior to use, make sure that swarf and dust have not collected in the area of the terminals.
 - During use, try to avoid swarf or dust on the tool from falling on the battery.
 - When suspending operation or after use, do not leave the tool in an area where it may be exposed to falling swarf or dust. Doing so could cause a short circuit that could result in smoke emission or ignition.

CAUTION ON LITHIUM-ION BATTERY

To extend the lifetime, the lithium-ion battery equips with the protection function to stop the output. In the cases of 1 to 3 described below, when using this product, even if you are pulling the switch, the motor may stop. This is not the trouble but the result of protection function.

1. When the battery power remaining runs out, the motor stops. In such a case, charge it up immediately.
2. If the tool is overloaded, the motor may stop. In this case, release the switch of tool and eliminate causes of overloading. After that, you can use it again.
3. If the battery is overheated under overload work, the battery power may stop. In this case, stop using the battery and let the battery cool. After that, you can use it again.

Furthermore, please heed the following warning and caution.
WARNING

In order to prevent any battery leakage, heat generation, smoke emission, explosion and ignition beforehand, please be sure to heed the following precautions.

1. Make sure that swarf and dust do not collect on the battery.
 - During work make sure that swarf and dust do not fall on the battery.
 - Make sure that any swarf and dust falling on the power tool during work do not collect on the battery.
 - Do not store an unused battery in a location exposed to swarf and dust.
 - Before storing a battery, remove any swarf and dust that may adhere to it and do not store it together with metal parts (screws, nails, etc.).
2. Do not pierce battery with a sharp object such as a nail, strike with a hammer, step on, throw or subject the battery to severe physical shock.
3. Do not use an apparently damaged or deformed battery.
4. Do not use the battery for a purpose other than those specified.
5. If the battery charging fails to complete even when a specified recharging time has elapsed, immediately stop further recharging.
6. Do not put or subject the battery to high temperatures or high pressure such as into a microwave oven, dryer, or high pressure container.
7. Keep away from fire immediately when leakage or foul odor are detected.
8. Do not use in a location where strong static electricity generates.
9. If there is battery leakage, foul odor, heat generated, discolored or deformed, or in any way appears abnormal during use, recharging or storage, immediately remove it from the equipment or battery charger, and stop use.
10. Do not immerse the battery or allow any fluids to flow inside. Conductive liquid ingress, such as water, can cause damage resulting in fire or explosion. Store your battery in a cool, dry place, away from combustible and flammable items. Corrosive gas atmospheres must be avoided.

CAUTION

1. If liquid leaking from the battery gets into your eyes, do not rub your eyes and wash them well with fresh clean water such as tap water and contact a doctor immediately. If left untreated, the liquid may cause eye-problems.
2. If liquid leaks onto your skin or clothes, wash well with clean water such as tap water immediately. There is a possibility that this can cause skin irritation.
3. If you find rust, foul odor, overheating, discolor, deformation, and/or other irregularities when using the battery for the first time, do not use and return it to your supplier or vendor.

WARNING

If a conductive foreign matter enters in the terminal of lithium ion battery, the battery may be shorted, causing fire. When storing the lithium ion battery, obey surely the rules of following contents.

- Do not place conductive debris, nail and wires such as iron wire and copper wire in the storage case.
- To prevent shorting from occurring, load the battery in the tool or insert securely the battery cover for storing until the ventilator is not seen.

NOTE

If left unattended with the restart prevention activated, the battery will be depleted.

REGARDING LITHIUM-ION BATTERY TRANSPORTATION

When transporting a lithium-ion battery, please observe the following precautions.

WARNING

Notify the transporting company that a package contains a lithium-ion battery, inform the company of its power output and follow the instructions of the transportation company when arranging transport.

- Lithium-ion batteries that exceed a power output of 100 Wh are considered to be in the freight classification of Dangerous Goods and will require special application procedures.
- For transportation abroad, you must comply with international law and the rules and regulations of the destination country.

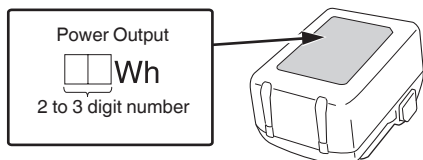

NAMES OF PARTS (Fig. 1–Fig. 13)

① Collet nut	⑰ Wrench
② Collet(1/8")	⑱ Collet hole
③ Bit (1/8")	⑲ Collet (1/4")
④ Depth guide	⑳ Shaft
⑤ Knob bolt	㉑ Bit (1/4")
⑥ Lock button	㉒ Work piece
⑦ Motor	㉓ Rotation of bit
⑧ Switch	㉔ Tool feed
⑨ Hook	㉕ Inner peripheral cutting (Clockwise)
⑩ Battery	㉖ Outer peripheral cutting (Counterclockwise)
⑪ Name plate	㉗ Display panel
⑫ LED light	㉘ Remaining battery indicator switch
⑬ Latch	㉙ Remaining battery indicator lamp
⑭ Pilot lamp	⑳ Air gun
⑮ Screw	㉑ Battery sliding grooves
⑯ Groove	㉒ Ventilation holes

SYMBOLS

WARNING

The following show symbols used for the machine. Be sure that you understand their meaning before use.

	M18DYA: Cordless Cut-Out Tool
	To reduce the risk of injury, user must read instruction manual.
	Always wear eye protection.
	Always wear hearing protection.
	Direct current
	Rated voltage
	No-load speed
	Disconnect the battery
	Switching ON
	Switching OFF
	Warning
	Prohibited action

Battery

	Lights ; The battery remaining power is over 75%
	Lights ; The battery remaining power is 50%–75%.
	Lights ; The battery remaining power is 25%–50%.
	Lights ; The battery remaining power is less than 25%
	Blinks ; The battery remaining power is nearly empty. Recharge the battery soonest possible.
	Blinks ; Output suspended due to high temperature. Remove the battery from the tool and allow it to fully cool down.
	Blinks ; Output suspended due to failure or malfunction. The problem may be the battery so please contact your dealer.

NOTE

To prevent the battery power consumption caused by forgetting to turn off the LED light, the light goes off automatically in about 3 seconds.

STANDARD ACCESSORIES

In addition to the main unit (1 unit), the package contains the accessories listed on page 13.

Standard accessories are subject to change without notice.

APPLICATIONS

- Window-removing and cutting of gypsum board

SPECIFICATIONS

Model	M18DYA
Voltage	18 V
No-Load Speed	28000 /min
Collet chuck capacity	1/8" or 1/4"
Weight	1.1 kg (BSL1820M)

NOTE

Due to HIKOKI's continuing program of research and development, the specifications herein are subject to change without prior notice.

Electronic control

- Restart prevention function
When the power is still switched on, the tool will not restart when a battery is installed. This function can be canceled once the tool is switched off.

NOTE

If left unattended with the restart prevention activated, the battery will be depleted.





- Braking Function
Brake is activated when the switch is turned off, stopping the motor's rotation.

CHARGING

Before using the power tool, charge the battery as follows.

- 1. Connect the charger's power cord to the receptacle.**
When connecting the plug of the charger to a receptacle, the pilot lamp will blink in red (At 1-second intervals).
 - 2. Insert the battery into the charger.**
Firmly insert the battery into the charger as shown in Fig. 4 (on page 3).
 - 3. Charging**
When inserting a battery in the charger, charging will commence and the pilot lamp will light continuously in red.
When the battery becomes fully recharged, the pilot lamp will blink in red. (At 1-second intervals) (See Table 1)
- Pilot lamp indication
The indications of the pilot lamp will be as shown in Table 1, according to the condition of the charger or the rechargeable battery.

Table 1

Indications of the pilot lamp (RED)		
Before charging	Lights on for 0.5 seconds and off for 0.5 seconds Blinks 	Plugged into power source
While charging	Lights continuously Lights 	—
Charging complete	Lights on for 0.5 seconds and off for 0.5 seconds Blinks 	—
Overheat standby	Lights on for 1 second and off for 0.5 seconds Blinks 	Battery overheated. Unable to charge. (Charging will commence when battery cools)
Charging impossible	Lights on for 0.1 seconds and off for 0.1 seconds Flickers 	Malfunction in the battery or the charger

- Regarding the temperatures and charging time of the battery.
The temperatures and charging time will become as shown in Table 2

Table 2

Battery	Charger	UC18YFSL
Charging voltage	V	14.4–18
Weight	kg	0.5
Temperatures at which the battery can be recharged		0°C–50°C
Charging time for battery capacity, approx. (At 20°C)		
1.5 Ah	min	22
2.0 Ah	min	30
2.5 Ah	min	35
3.0 Ah	min	45
4.0 Ah	min	60
5.0 Ah	min	75
6.0 Ah	min	90
8.0 Ah	min	120
Number of battery cells		4–10

NOTE

The recharging time may vary according to the ambient temperature and power source voltage.

CAUTION

When the battery charger has been continuously used, the battery charger will be heated, thus constituting the cause of the failures. Once the charging has been completed, give 15 minutes rest until the next charging.

- 4. Disconnect the charger's power cord from the receptacle.**
- 5. Hold the charger firmly and pull out the battery.**

NOTE

Be sure to pull out the battery from the charger after use, and then keep it.

Regarding electric discharge in case of new batteries, etc.

As the internal chemical substance of new batteries and batteries that have not been used for an extended period is not activated, the electric discharge might be low when using them the first and second time. This is a temporary phenomenon, and normal time required for recharging will be restored by recharging the batteries 2–3 times.

How to make the batteries perform longer.

- (1) Recharge the batteries before they become completely exhausted.
When you feel that the power of the tool becomes weaker, stop using the tool and recharge its battery. If you continue to use the tool and exhaust the electric current, the battery may be damaged and its life will become shorter.
- (2) Avoid recharging at high temperatures.
A rechargeable battery will be hot immediately after use. If such a battery is recharged immediately after use, its internal chemical substance will deteriorate, and the battery life will be shortened. Leave the battery and recharge it after it has cooled for a while.

CAUTION

- If the battery is charged while it is heated because it has been left for a long time in a location subject to direct sunlight or because the battery has just been used, the pilot lamp of the charger lights up green or lights for 1 second, does not light for 0.5 seconds (off for 0.5 seconds). In such a case, first let the battery cool, then start charging.
- When the pilot lamp flickers in red (at 0.2-seconds intervals), check for and take out any foreign objects in the charger's battery connector. If there are no foreign objects, it is probable that the battery or charger is malfunctioning. Take it to your authorized Service Center.

MOUNTING AND OPERATION

Action	Figure	Page
Removing and inserting the battery	3	2
Charging	4	3
Mounting the hook	5	3
Installing the bit *1	6	3
Exchanging the collet *1	7	4
Adjusting the depth of cut *2	8	4
Switch operation *3	9	4
How to use the LED light	10	4
Cutting operation *4	11	4
Remaining battery indicator	12	5
Selecting accessories	—	14

- *1 Installing the bit
Exchanging the collet

NOTE

- Ensure that the lock button returns when you release it.
- If you tighten the collet without attaching a bit, the collet may become deformed. When you do not install a bit, tighten the collet nut only lightly.

- *2 Adjusting the depth of cut

NOTE

- The depth guide (dust adapter) should be adjusted before each cut.
- Adjust the tip of the bit so that it protrudes at least 3 mm from the material for a clean finish.
- Ensure that there is enough space under the material so that the bit does not make contact.

- *3 Switch operation

WARNING

Ensure that the switch is in the OFF position before installing the battery.
Pressing the ON side ("I") of the switch activates it, and pressing the OFF side ("O") stops it. When the switch is in the center position, it is in the "OFF" state. (Fig. 9)

- *4 Cutting operation



- Make sure the bit is not contacting the workpiece before the switch is turned on.
- Before using the tool on an actual workpiece, let it run for a while. Watch for vibration or wobbling that could indicate improperly installed bit.
- Be careful of the bit rotating direction and the feed direction.

LED LIGHT WARNING SIGNALS

This product features functions that are designed to protect the tool itself as well as the battery. When any of the safeguard functions are triggered, any of the LED light will blink as described in **Table 3**.

In this case, follow the instructions described under corrective action.

Table 3

Safeguard Function	LED Light Display	Corrective Action
Overload Protection	On 0.1 second/ off 0.1 second 	Remove the cause of the overloading.
Temperature Protection	On 0.5 second/ off 0.5 second 	Allow the tool and battery to thoroughly cool.

MAINTENANCE AND INSPECTION

WARNING

Be sure to turned off the switch and remove the battery before maintenance and inspection.

1. Inspecting the bit

Continued use of a dull or damaged bit will result in reduced cutting efficiency and may cause overloading of the motor. Replace the bit with a new one as soon as excessive abrasion is noted.

2. Inspecting the mounting screws

Regularly inspect all mounting screws and ensure that they are properly tightened. Should any of the screws be loose, retighten them immediately. Failure to do so could result in serious hazard.

3. Maintenance of the motor

The motor unit winding is the very "heart" of the power tool.

Exercise due care to ensure the winding does not become damaged and/or wet with oil or water.

4. Inspection of terminals (tool and battery)

Check to make sure that swarf and dust have not collected on the terminals.

On occasion check prior, during and after operation.

CAUTION

Remove any swarf or dust which may have collected on the terminals.

Failure to do so may result in malfunction.

5. Cleaning on the outside

WARNING

Wear protective glasses and a dust mask when cleaning the filter with an air gun.

Failure to do so may result in inhalation or exposure of the eyes to debris or dust.

Use an air gun or other similar tool to remove materials, chips, etc. which have adhered to the body (especially where indicated in **Fig. 13**), and wipe with a soft dry cloth or a cloth moistened with soapy water. Do not use chloric solvents, gasoline or paint thinner, for they melt plastics.

6. Storage

Store the power tool and battery in a place in which the temperature is less than 40°C and out of reach of children.

NOTE

Storing lithium-ion batteries.

Make sure the lithium-ion batteries have been fully charged before storing them.

Prolonged storage (3 months or more) of batteries with a low charge may result in performance deterioration, significantly reducing battery usage time or rendering the batteries incapable of holding a charge.

However, significantly reduced battery usage time may be recovered by repeatedly charging and using the batteries two to five times.

If the battery usage time is extremely short despite repeated charging and use, consider the batteries dead and purchase new batteries.

CAUTION









In the operation and maintenance of power tools, the safety regulations and standards prescribed in each country must be observed.

Important notice on the batteries for the HiKOKI cordless power tools

Please always use one of our designated genuine batteries. We cannot guarantee the safety and performance of our cordless power tool when used with batteries other than these designated by us, or when the battery is disassembled and modified (such as disassembly and replacement of cells or other internal parts).

NOTE

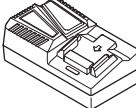
Due to HiKOKI's continuing program of research and development, the specifications herein are subject to change without prior notice.

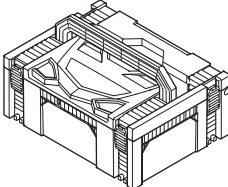
	M18DYA	
	(2MC)	(NN)
 1/8"	1	1
 1/4"	1	1
	2	2
	1	1
	1	1
	2	—
	1	—
	2	—
	1	—



1/8"

378886



1/4"

378889



378891



377128



372229

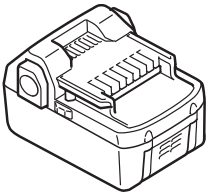

BSL18..

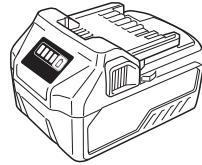
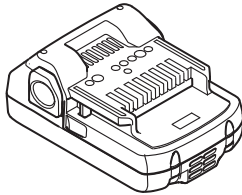

BSL36..18

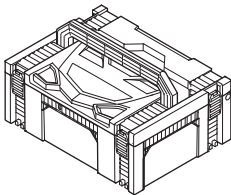

336471

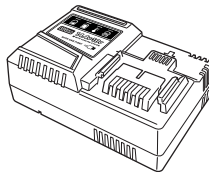

UC18YSL3 (14.4 V-18 V)

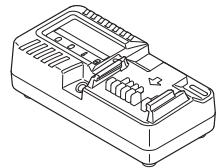

UC18YKSL (14.4 V-18 V)

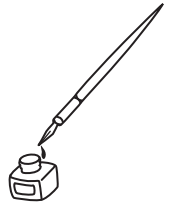

Koki Holdings Co., Ltd.

Shinagawa Intercity Tower A, 15-1, Konan 2-chome,
Minato-ku, Tokyo, Japan